



# **THINK AUTOMOTIVE**

OIL COOLING AND FLUID TRANSFER SPECIALISTS

Manufacturers of **MOCAL** and **laminova**

VOLUME 3

## Conditions Of Sale

Prices are available to view online at [www.thinkauto.com](http://www.thinkauto.com). Prices are subject to alteration without prior notice. Add VAT 20% for all UK and EU retail sales. Discounts available for trade customers.

England - Next day carrier £8.95. Next day before 10am £19.50. Northern Ireland - £15. Prices subject to carrier service.

First class letter post £3.95. Carriage in UK, not charged on orders over £500 NET. In the event of goods becoming lost or damaged in transit, the Seller will make every effort to obtain compensation from the carrier but does not accept further responsibility. We can arrange insurance if requested.

## Terms

*Nett cash will be due in 30 days to approved customers. Title to goods supplied is retained until full payment is received.*

## Warranty

1. Every effort is made to ensure quality material and good workmanship. In the event of any defect being discovered in any parts of the Seller's manufacture within twelve months of the date of dispatch from the Seller's works, or before 12,000 miles/19,200 Kilometres of use in the case of automobile components. Such defect must be proved to the Seller's satisfaction to be due to defective material or workmanship, then subject to the conditions hereinafter specified, the Seller will repair the defective part or replace it with a new part free of charge.
2. This warranty shall not apply to any defect caused by wear and tear, neglect, misuse or improper storage, or failure to follow the Seller's instructions (if any), unauthorised reconditioning or repair.
3. Insofar as is permitted by Statute, the Seller's liability under this clause shall be in substitution for and exclude any conditions, warranty or statement as to the quality of the goods or their fitness for any purpose whether expressed or implied by Statute or otherwise and save as provided this clause, the Seller shall not be under any liability whether in contract or in tort in respect of defects in goods delivered or for any injury, damage or loss resulting from such defects or from any work done in connection therewith.
4. In the case of goods which are not of the Seller's manufacture, the Seller shall use their best endeavour to pass on to the Buyer the benefit of the manufacturers warranty (if any).

## Suitability

1. Where suggestions as to suitability for a particular vehicle are made in this catalogue these are for an unmodified vehicle used for the purpose for which it was manufactured.



SCAN ME!

View all our products and prices online at [thinkauto.com](http://thinkauto.com)

## How To Find Us

From M3, at junction 1, take the A308 exit to Staines. Continue down the A308 for 1 mile then turn left onto Littleton Road and follow the road onto Spelthorne Lane. At the mini roundabout, take the second exit onto Ashford Road and continue straight for 0.2 miles until you reach Thames House located on the right.

From M25, at junction 13, take the A30 towards Staines. As you approach the Crooked Billet roundabout, take the left hand lane sign posted A308 Kingston. Continue onto Staines Bypass/A308. At the next roundabout take the second exit onto Kingston Road/Staines Road West/A308, then turn right onto Ashford Road and continue straight for 0.2 miles. We are on the left. We are 15 minutes by road from Heathrow and 45 minutes to an hour from Gatwick.

When travelling by rail the nearest station is Sunbury, operated by South West trains. Ashford station is a slightly further alternative but with better connections to London and Reading. In both circumstances you can get the 216 bus to Chertsey Road. From there, it is a short walk across the A308 Staines Road West and down Littleton Road. At the end of the road turn left onto Ashford Road, and we are on the left hand side after 300 feet.

For help planning your journey visit <http://www.tfl.gov.uk/journeyplanner>

## Contact

Tel: 020 8568 1172

Email: [info@thinkauto.com](mailto:info@thinkauto.com)

Web: [www.thinkauto.com](http://www.thinkauto.com)

Address: Thames House  
Ashford Road, Ashford, Surrey  
TW15 1XB

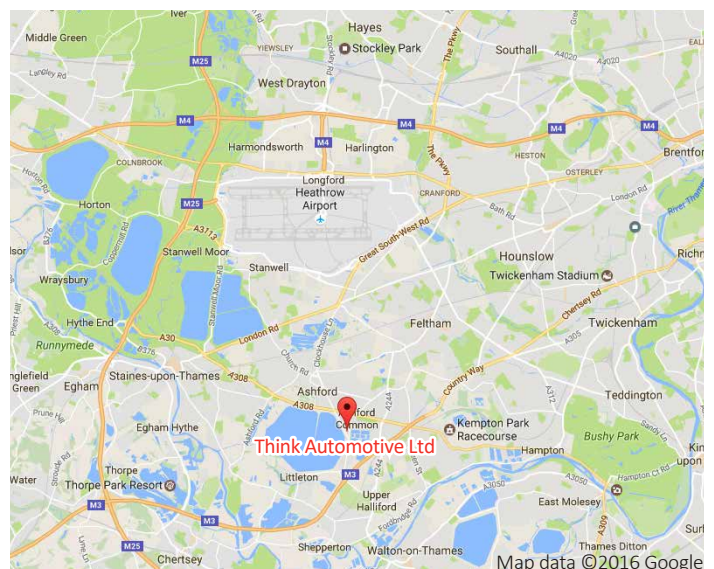
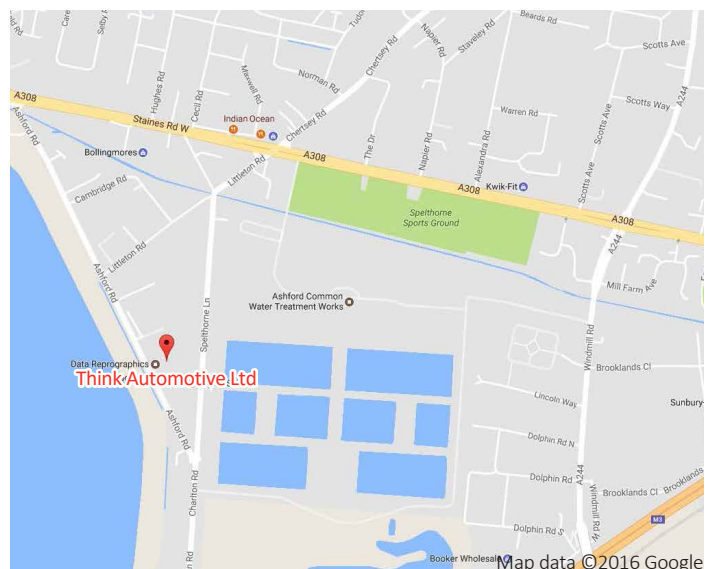

## Contents

About Us	4	Hose Assembly Tools	56
<b>MOCAL</b> Pressed Plate Coolers	8	Adapters	57
Part Numbers For <b>MOCAL</b> Pressed Plate Coolers	8	Banjo Adaptors -6 Upwards (Fuel & Oil)	63
<b>MOCAL</b> Flat Tube & Fin Oil Coolers	10	Bolts (AN775) For Oil & Fuel Banjos	63
Setrab Oil Coolers	10	Banjo Adaptors -3 & -4 (Brake & Clutch)	63
Proline SLM Slimline Cooler	11	Bolts For Brake & Clutch Banjos	64
Low Level High Flow Banjo Adapters	11	Aluminium Fuel Blocks	64
Fittings & Adapters For <b>MOCAL</b> M22 Female and Setrab Proline	11	Fuel/Oil Pressure Adapters	64
PWR 37mm Engine, Transmission & Power Steering Coolers	12	Bulkhead Adapters	65
PWR 19mm Transmission & Power Steering Coolers	12	Blanking Plugs	66
Original Equipment or replacement Oil Coolers	12	Blanking Caps (AN929)	67
Nissan GTR R35 Oil Cooler	13	Weld On Connections	67
Oil Cooler Mounting Bracket	13	EFI Adapters	68
<b>Laminova</b> Oil Coolers	14	Aluminium Caps & Plugs	68
<b>Laminova</b> ECD54 Engine Oil Coolers	16	Red Caps & Plugs	68
Engine Oil Cooler Installation Kits	17	Jiffy-tite™ Quick Connect Fluid Fittings	69
Automatic Transmission	18	One Way Check Valves	72
Oilstats	18	Quick Release Drybreak Couplings	72
Billet Oilstat	18	Fuel Sampling Kits	73
Oil Cooler Take-Offs	19	Brake & Clutch Cylinders	73
Temperature Gauge Adapters	22	Taps	73
Remote Filter Heads	23	Seals, Washers & Gaskets	73
Complete Remote Oil Filter Kits	23	Aeroquip Firesleeve	74
XRP In-Line Engine Oil Filters	24	Heat Resisting Tape	74
Early Warning Systems	25	Aluminised Heat Resisting Cloth	74
T Pieces & Oil Pressure Gauge Adapters	25	Aluminised Heat Resisting Sleeves	74
Sandwich Plates Between Engine & Filter	25	Heat Resistant Sleeve	74
Warning Lights	26	Heat Shrink Sleeving	74
<b>MOCAL</b> Temperature Strips	26	Exhaust Pipe Wrap Webbing	74
Conversions To Spin Off Type Filters	26	Grommet Seals	75
Hose & Fittings, An Overview	27	Hose Support Clips	75
Understanding Hose & Fitting Sizes	29	Brake Balance Adjuster	76
<b>MOCAL</b> 100R6 Hose	30	Aston & Monza Filler Caps	77
<b>MOCAL</b> SAE J30 R9 Fuel Injection Hose	30	Aluminium Screw Cap	78
Fittings For 100R6/R9 Hose	31	Radiator Caps And Necks	79
Fittings For 100R6/R9/SPH Hose	32	Aero Flush Fitting Caps	79
Aeroquip "Push On Hose"	33	Smarty Flush Cap	80
AQP Socketless Hose	33	Tank Breather Valves	80
Fittings For Push On Hoses	33	Fuel Tank Caps For Superbikes	80
Replacement Original Equipment Hoses	33	Quick Fill Refuelling Equipment	81
Aeroquip FC333 Hose	36	Air Jack System	81
Aeroquip Startlite Hose	36	Filters For Electric Pumps	83
GRH <b>MOCAL</b> Racing Hose	36	Electric Fuel Pumps For Fuel Injection	83
G210 <b>MOCAL</b> Racing Hose	36	Electric Oil Pumps	84
Reuseable Fittings For FC333, Startlite & G210 Hose	37	Electric Water Coolant Circulation Pumps	85
Swaged Fittings For FC333, Startlite	39	Oil Pressure Accumulators, Accusump	89
Dual Feed Assemblies For Holley Double Pumper Carburettors	39	Classic Dashboard Instruments	90
ProGold Hose	40	Instrument (Gauge) Isolators	90
Fittings For ProGold Hose	40	Catch Tanks	90
Stainless Braided TFE Hose	43	Dry Sump Tanks	91
Fittings For 2807/ TFE Racing Hose, 666 & <b>MOCAL</b> TFE Hoses	43	Rain Light	91
Stainless Braided TFE Brake Hose	47	<b>MOCAL</b> Fuel Swirl Pots	91
Swaged Fittings For <b>MOCAL</b> TFE Hoses	48	Quick Release Steering	91
Special purpose Hoses	50	Roll Control Valves	91
Silicone Rubber Coolant Hoses	51	Bonnet Catches	91
This is a small selection of the reducers available.	53	Millers Oil	92
Pro-Clamps - Aeroquip	53	Hose Assembly Instructions	96
Stainless Steel Overbraid	53		
Mo-Clamps, Blue & Red Mo-Clamps	53	Alphabetical Index	100
Worm Drive Hose Clamps	54	Part No Index	101
Worm Drive Embossed Band Clamps	54	Useful Charts	111
Mikalor Clamps	54		
Oetiker Hose Clamps	54		
Wiggins Couplings	55		
Aluminium Tube & Fittings	55		
Flareless Tube Fitting	55		
Metal Brake Tube & Fittings	55		

## About Us

### What We Do

Think Automotive was founded in 1967 to produce packaged oil cooler installations and has continued to expand into many aspects of high performance automobile plumbing. We manufacture the **MOCAL** range of oil to air coolers and associated products. Our products are available from leading motor sport outlets throughout the world.

Following Think Automotive's acquisition of Laminova in 2018, design and production has been moved to the UK and now enables us to develop and implement holistic cooling circuit solutions for the engine, charge air, and hybrid components such as the electric motor, battery, and power electronics.

We also distribute Setrab and PWR oil coolers making us the world's leading oil cooler specialists. We distribute Aeroquip hoses and fittings and related products from the USA, UK & Germany and suitable products from their Aerospace division. The ranges of Quick Connect fittings, products from BMRS ProGold, Speedflow, Krontec, together with our own **MOCAL** range of fittings and adapters allow us to offer the most comprehensive hose service anywhere. In addition to **MOCAL** oil pumps we have Weldon and Jabsco plus EWP water pumps and Accusump pressure accumulators. We have built up a vast knowledge of problems connected with flow and pressure drops and are happy to advise on suitable equipment for complete fuel and oil installations. We are also the world's biggest outlet for filler caps.

Manufacturing of special items, warehousing and sales, takes place at our main premises. We are happy to send products to anywhere in the world. Wherever possible, mail orders are dealt with on a same day basis and we are pleased to see callers at our trade counter, we accept all major credit and debit cards. We have a web site and online shop at [www.thinkauto.com](http://www.thinkauto.com).

**THINK  
AUTOMOTIVE**

[thinkauto.com](http://thinkauto.com)



[mocal.co.uk](http://mocal.co.uk)

**laminova**

[laminova.com](http://laminova.com)



Think Automotive is ISO 9001-2015 accredited company.

### Who We Are

Rob Potter, Managing Director, has more than 50 years of experience in automotive plumbing. He is available to advise on problematic, technical issues.

Matthew Potter, Director, aided by Christopher Simms, deals with the day to day running of the business.

Our sales team consists of Nick Fitzgerald, Santino Meale, and Joel Amos. Nick is responsible for international exports, while Santino heads U.K. sales, assisted by Joel.

Accounts receivable is overseen by Donna Smith, while purchasing is managed by Dano McGrath.

Richard Tomkins is responsible for our in-house quality control and is our design engineer.

In addition to the business, Rob and Matthew are still involved with motor sport. Rob has, prior to the pressure of business growing too great, run very successful Chevrolet Camaros in the European and British touring car championships and now works on his 1968 big block Corvette historic FIA racer.

### Our Services

Our services span from advice and sales, in store as well as over the phone, and via email or social media. We also have an online shop from which you can purchase our products: [www.thinkauto.com](http://www.thinkauto.com).

#### Design

Utilising the latest engineering computer software, combined with the skills of our team, we are able to assist in the design and development of all manner of cooling solutions for Automotive, Aviation, Aerospace, Defense, Industrial and Motorsport industries.

#### In Store

Our in store opening times are Monday - Friday 9am - 5.30pm, excluding Christmas and bank holidays. We have a trade counter open 9am - 5pm for sales and collection of parts. We can also make hoses while you wait and help you diagnose what parts would be best suited for your needs as well as their fitting.

#### Phone Lines

Our phone lines are open Monday - Friday 9am - 5.30pm, excluding Christmas and bank holidays. This includes sales, purchasing, accounts, advice on parts and general customer queries.

#### Online

Parts can be bought online from our website: [www.thinkauto.com](http://www.thinkauto.com), as well as by email: [info@thinkauto.com](mailto:info@thinkauto.com). You can also find us on facebook and twitter @thinkauto, where we post all our latest updates and quickly aim to respond to queries and feedback.

#### Distributors

We have distributors throughout the world and are happy to put you in touch with your local stockist. Please visit our website to see the list of distributors.

## Oil Cooling, An Overview

We supply oil coolers for use in many applications both industrial and automotive. This catalogue is aimed at automotive applications.

Why do we need an engine oil cooler?

The design of any car, with the exception of the many that are fitted with an oil cooler as standard, will ensure that just sufficient cooling by airflow across the sump takes place under normal conditions of use to keep the oil of a chosen viscosity at its design temperature, without for reasons we will discuss later, overcooling. It follows that changes to the specification or usage of the vehicle can cause the oil to exceed its design temperature. The changes most likely to cause an increase in oil temperature are:

- Increase in rpm, the oil cooling requirement of an engine will increase up to threefold for an increase of 1000rpm, making this the most common cause of engine oil overheating. German specification cars are always designed with extra oil cooling because of possible high speed running on unrestricted autobahns. On the track the almost constant use of high rpm makes an oil cooler mandatory, even in an unmodified engine.
- Obstruction of airflow to the sump, caused by fitting sump guards, spoilers etc.
- Oil circulation through a turbo charger not only lubricates but also removes a large amount of heat which will add to the overall cooling requirement.
- Increasing the power output of the engine will increase combustion temperatures but except in the cases where oil is used to cool the piston crowns, most of the excess heat will be taken away by the water coolant system.

## Overheated Oil

Oil as it gets hotter becomes thinner (less viscous), losing its film strength, this film strength supported by oil pressure is what keeps bearing surfaces from touching, once bearing surfaces touch, metal is removed, clearances widen, oil pressure drops, the contact surfaces are further worn away and immediate engine failure takes place. It is also worth considering that, in the modern engine, oil is used as a coolant of pistons crowns, if the top of the piston becomes too hot detonation takes place causing loss of power or even piston/gasket failure. Some oils are advertised as being able to cope with higher temperatures, this is easily achieved by supplying a more viscous oil that will have greater film strength for a given temperature, the down side is that at lower temperatures there will be higher friction/pumping losses. The oils recommended for everyday motoring will have a viscosity sufficient to cope with the warmest extremes of expected motoring conditions, by fitting an oil cooler and oilstat a very low viscosity oil, giving increased power and decreased fuel consumption during relaxed motoring can be used. It will be appreciated from the foregoing that there is no optimum engine oil temperature, modern oils will not be damaged by high temperatures although some may leave varnish deposits which can block oil ways. Every engine will have a different oil temperature requirement but, as a general rule temperatures in excess of 110°C should be avoided.

## The Need For Oil Coolers

Oil coolers are used for cooling gearboxes, crown wheel and pinion units, differentials and power steering pumps where the primary problem is not so much concerned with avoiding metal to metal contact but in preventing loss of tolerances due to heat expansion of metals which in turn lead to greater friction resulting in a runaway spiral of heat build up. In road usage the only problems experienced are with automatic transmissions when vehicles are used for towing, many vehicles have some form of oil cooling but this is usually inadequate, extra cooling should always be provided because even if actual breakdown does not occur, higher temperatures shorten

the life of seals which can be as expensive to replace as an entire gearbox.

Race track usage leads to higher temperatures due to higher power loads and increased activity in gear changing, wheelspin and steering wheel twirling.

## Oil To Air Coolers

The most popular oil to air coolers are the pressed or stacked plate coolers which were first made in the late 50's. The cooler consists of a variable number of aluminium pressed plates forming oil ways and end tanks, the oil ways contain turbulators which not only break down boundary layer effect in the flow to obtain maximum heat dissipation without undue pressure drop but also because they are brazed to both surfaces of the plates hold them together under pressure. The oil ways are interspersed with aluminium strip louvred and formed into corrugations to provide airways.

The design is beautifully simple and efficient and most suitable for mass production, but it is restricted to a 2 thickness and a limited amount of lengths.

Pressed Plate Cooler

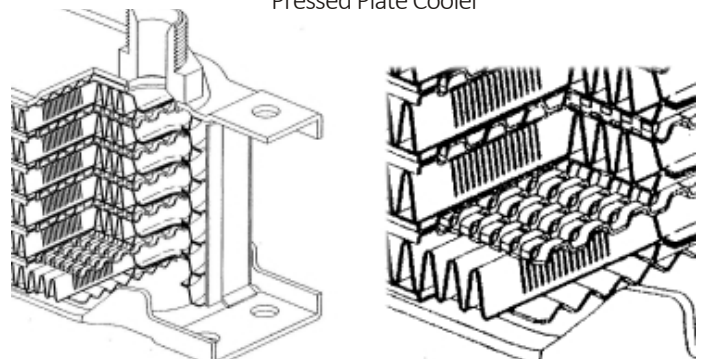

Making a comeback is the tube and fin cooler consisting of a number of preformed flattened tubes surrounding turbulators and separated by corrugated airways, this is a more flexible design allowing infinite lengths, depths can be in multiples of the tube width, however end tanks have to be made separately resulting in a more expensive and heavier assembly. The finned tube oil cooler is an anachronism only suitable where space is unlimited.

The current money is no object attitude prevailing in the top echelons of motor racing has resulted in a couple of aerospace heat exchanger manufacturers becoming interested in supplying their plate and bar coolers to the racing car industry they are fabricated from strip, and can be made to the exact size to suit the customers packaging requirements.

Tube & Fin Cooler

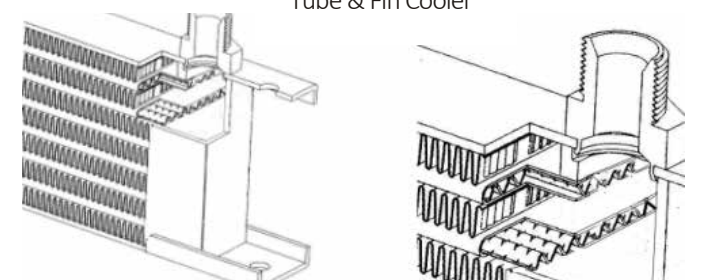

## Oil To Water Coolers (Laminova)

Until the last 5 years the oil to water cooler or fluid to fluid cooler has been more of a rarity in automobile usage. The most common the tube and fin in a shell cooler, popular in marine usage is too heavy and cumbersome. Up to recently the ubiquitous pressed plate type of oil to air cooler but in a fabricated water jacket has been the answer, now the amazing Laminova laminar flow cooler has opened the automotive market to oil to water coolers. The main components are two aluminium extrusions, one forming the outer shell, the other the core which by some magical process has been machined to provide fins 0.2 mm ( 7 thou) thick and 3mm high and spaced 0.3mm (11 thou) apart through which the oil flows, such

restrictive finning would normally cause a huge pressure drop, but by introducing channels in the finning, the oil flow is kept laminar as opposed to turbulent as in other cooler designs and the pressure drop remains low. The water flows through extruded channels in the outer core, removable plugs/restrictors control water pressure drop. This construction is pretty versatile the shell and core being made in 4 different diameters with, in theory, infinitely variable lengths. For very compact installations, cores may be slotted into each other. The secret to obtaining the best performance is to tailor the removable plugs to obtain the best oil temperature drop without compromising the water temperature. The doughnut cooler has a variable number of pressed plates forming oil and water ways, the oil ways containing turbulators. A pressure relief valve is incorporated to allow oil to bypass the oil ways during cold starts, excessive oil flows or blockage. Pressure drops through this type of cooler are high. The previously mentioned aerospace outfits can also supply custom built fluid to fluid bar and plate coolers.

**laminova**



## The Best Oil Coolers

All the coolers discussed here, except the finned tube and the Laminova are as efficient as each other in so far as greater heat rejection can only be obtained at the expense of oil pressure drop or air pressure drop. On the oil side the performance is controlled by the design of the turbulators, if you increase the amount of turbulence and make the oil follow a more tortuous path so as to bring it into greater contact with the cooling surface area to obtain greater heat dissipation you will increase the oil pressure drop, often the very problem you are fitting an oil cooler to avoid. On the air side if you increase the pitch of the corrugations or increase the depth (front to back measurement) you will increase the air pressure drop, thus requiring higher vehicle speed or sophisticated ducting to obtain better results.

The fluid to fluid cooler becomes viable when packaging constraints do not allow for mounting a cooler in the airstream and where there is enough thermal capacity in the water radiator to cope with the extra loads, because engine coolant warms more quickly than the oil, the oil warm up is quicker which can show benefits in engine wear and economy. The Laminova cooler is able to achieve a high degree of efficiency within a slim envelope because the unique finning provides an enormous cooling surface area in contact with the oil. Although not as cost effective as the pressed plate cooler, there are bonuses in that it is very strong and unlikely to be damaged in any but the biggest crash and it may be stripped for cleaning purposes, invaluable after an engine blow up.

The doughnut cooler is designed for ease of installation, fitting between filter head and filter and using a bypass water flow (in a similar fashion to a car heater), as it cannot use the full water flow performance cannot match the Laminova, it is made of stainless steel thus incurring a weight penalty compared to all others.

The bar and plate coolers are not, in their construction, any more efficient than the pressed plate, tube type or Laminova coolers, their value lies in their being able to be made to exactly match the

vehicle requirements where all relevant parameters, oil flow, air flow, temperatures, acceptable oil pressure drop, and air pressure at varying speeds are known. These hand made coolers are priced in thousands of pounds. We think that the design of the pressed plate cooler is the best compromise to cover all types of motoring and motor sport, irrespective of price, the best of the competitors offer very similar performance because their design closely follows our product.

In later pages we show graphs showing performance of various coolers, these are of limited use as all parameters are not usually known, however it is useful to make performance comparisons between cooler types. Heat dissipated is not necessarily the sole reason for choosing a cooler, A larger cooler may be chosen to avoid excessive oil pressure drop, be aware that the more rows/tubes and the shorter their length the smaller will be the pressure drop or in the case of the Laminova the longer the cooler the smaller the oil pressure drop although the water pressure drop is greater.

## Installing An Oil Cooler

In the case of the air to oil cooler, The oil cooler will only achieve results where a volume of air is passing through the fins. The amount of heat dissipated by radiation is negligible. In practice the most convenient position for the oil cooler is in front of the water radiator where a flow of air is guaranteed. Even in cases where the water cooling is marginal, placing the cooler in this position will have hardly any effect on water temperature. The sheer volume of air passing through the cooler ensures that the air is only heated a few degrees; not enough to affect the water radiator performance, and as the oil cooler is a more efficient device for extracting heat from the engine, the overall effect is helpful. However, where water cooling is marginal it is essential that the oil cooler be placed against the water radiator face, otherwise warmer air leaving the oil cooler will become turbulent on meeting air at ambient temperatures and will not pass through the water radiator. If placing of cooler and water radiator in close proximity is not possible then a duct of thin aluminium should be made to exclude the ambient air. If space is not available in front of the water radiator due to an electrical fan for instance, the cooler may be mounted behind the radiator and will still work well for the reasons already given.

In the unlikely event of an insufficient space being available either behind or in front of the water radiator, the radiator grille may be moved forward by using longer screws and spacers. Alternatively oil cooler size holes may be cut in the forward bulkhead either side of the water radiator and air from the grille ducted to the cooler. An illustration is given of the ways in which the cooler may be mounted using our standard universal brackets. Mounting on bottom brackets alone will suffice up to 13 row coolers after that all 4 brackets should be used, a system of spacers and long bolts tying in all four brackets will spread the load. The cooler will expand with heat so allowing some flexibility in the mountings will prolong cooler life. The weakest part of the plate type cooler is the brackets, breakage of which often damage the whole cooler. If fitted to any vehicle that may be subject to vibration or twisting of the mounting platform, consideration should be given to abandoning the brackets and mounting in a cradle, locating with cable ties or an elastic strap should be sufficient as the hose will provide some restraint. Oil coolers may be mounted anyway up and are self bleeding, the resistance to oil flow through the matrix means that tanks will fill up evenly pushing out the air before the oil flows through.

For packaging reasons it may be necessary to use two coolers, if possible connect in series although this will double the pressure drop, If parallel connections are made, unless the oil pressure drop through each is equal oil will take the line of least resistance and pass through only one, therefore pipe lengths and air flow at all times must be matched for the system to work. Two coolers in parallel will halve the pressure drop. If a Laminova oil to water cooler is used, the whole engine water flow should pass through the unit for maximum cooling effect but if this is not possible a partial flow may be obtained by teeing off and running in parallel with water radiator/heater matrix. We can supply a plug or restrictor to divert

more water flow through the annular water ducts of the core, this will restrict the overall flow of water and may cause problems with the main cooling system and is more likely to be beneficial in partial flow installations, we suggest experimenting with restrictors if more oil cooling is required. Please ask for rebuild instructions. The Donut oil cooler can only be fitted to engines with spin on type oil filters. The most convenient place to obtain a coolant flow is usually the heater pipes, we provide Tees in both 1/2" & 5/8" diameter to suit all applications.

## Getting Oil To The Cooler

*Fitting an engine oil cooler to a wet sump vehicle.* The starting point is to identify a point from which the oil supply may be interrupted and diverted through an oil cooler, in most cases this will be a full flow oil filter, some cars, e.g. BMC A series, MG B have an external pipe leading to the oil filter, replacing this pipe with flexible hoses to and from the cooler is an easier alternative. If we decide on using the filter, we have further choices, either to place an oil cooler take off (sandwich plate) between filter head and cartridge/bowl, or if more convenient between filter head and block. In either of these cases if room is limited (a sandwich plate adds about 1 3/8" / 34mm) a smaller filter, changed more frequently, should be considered or fit a remote filter take off plate in place of filter and run hoses to a remote filter head in a convenient place. When working out such installations it is important to remember that oil flows through the filter from the outside to the centre, hence the outer hole on the take off plate will be the output from the pump. It is preferable to filter hot oil so install with a cooler fitted in the return from remote filter to engine. We sometimes use a new filter head assembly with built in cooler take offs, e.g. Jaguar models. For the Rover, Buick, Oldsmobile, V8 where space can be very limited we can supply a replacement oil pump cover with outlets for a remote filter plus oil cooler if required. The Triumph Dolomite and Stag have a cover plate on the block which may be removed and replaced with a special take off.

*Fitting an engine oil cooler to a dry sump vehicle.* It is standard practice to put an oil cooler in the return line from the sump to tank. The reasoning behind this would seem to be that as the tank is open to atmosphere, there is no pressure on the cooler and in the event of cooler damage the consequent leak would not be as great as on a pressure line. However there is never a pressure release valve on the suction part of a dry sump pump and in a cold start situation the oil backing up through the cooler can cause pressures high enough to blow up all types of cooler. Also oil on the return to the tank will be in an aerated condition which is thermally less efficient to cool. Serious consideration should be given to fitting the cooler in the pressure line, after the oil filter.

Fitting an automatic transmission cooler. Most modern automatic transmissions tap into the return from torque converter to sump, where very little pressure exists, to obtain a full flow of oil through an oil cooler tube in the water radiator, a secondary cooler may be connected in series by interrupting this flow cutting one of the oil pipes leading to the water radiator and securing hoses to the severed ends using hose menders. Where water overheating is a problem in arduous conditions or where the primary cooler has failed the water radiator may be bypassed by connecting directly to the **MOCAL** cooler by cutting both hoses, the hoses to the primary cooler may be taped up to avoid the ingress of dirt if the system is to be reinstated. Old Borg Warner gearboxes are provided with means of tapping the oil flow either by a loop pipe or two plugs on the right hand side of the gear box just above the sump. Renault gearboxes have two plugs adjacent to the left hand drive shaft. Only ZF boxes with an existing cooler can have additional cooling.

Cooling gearboxes and steering pumps. Some gearboxes and all power steering pumps have an oil pressure system that can be tapped for oil flow otherwise a remote pump is required, we offer three types, see page 83. We have also supplied the Holley fuel pump, see page 81, for this purpose with satisfactory results. When designing an installation these pumps require a switch either built in or manual as pumping cold oil is not recommended. Add extra oil to fill cooler, pump and pipes which must be at or below the normal

oil level otherwise the oil level in the gear housing will be too high when the pump is switched off. When returning oil onto the gears do so after the point of contact to avoid pumping losses caused by cool oil. If difficulty is experienced in supplying ram air to an oil to air cooler we can supply a fan and housing see page 13. Use -6 (3/8" bore) hose.

## Oilstat Needs

Prolonged use of a car engine in conditions where the oil cannot reach its correct working temperature will cause sludge formation and crankcase oil dilution, leading to excessive wear especially in the cylinder bores. Optimum engine power will only be delivered at correct temperatures. The elimination of drag in engines caused by cold oil is a most important consideration, especially with a racing engine, revving the engine without a load will not put much heat into the oil and devices for preheating the oil may not be available.

Control of the oil flow through the cooler can be controlled in two ways. Using a thermostatic device that we call an oilstat set to divert oil to the cooler at 80°C (although a wide range of settings is available for special applications). This is the minimum temperature required to evaporate and dispel contaminating substances. The **MOCAL** oilstats are built into the oil cooler take off or available as a separate unit to be fitted into the oil lines. Some economy can be gained by fitting a high temperature oilstat to an automatic transmission. Temperatures on racing boxes may be too high for an oilstat (140°C max).

## Measuring Oil Temperature And Warnings

Oil temperature sensing is a necessary tool to use in decisions about oil cooling. We can assist in many ways. The first decision is to establish what temperature you need to know, is it *a*) the maximum oil temperature i.e. the oil in the sump or *b*) if a cooling device is fitted, the temperature of the oil going to the bearings (the first bearing not the last in line) or gears. If you require *a*, fit the sensor in the sump in the oil line going to the cooler in a remote filter installed before the cooler or in an oil cooler take off between filter head and filter. If *b*, in the return from the cooler or oilstat if fitted. We make adapters to fit in the oil lines, see page 21, or provision can be made for temperature gauge tapping in oil cooler take offs and remote filter heads, see pages 18 & 22, respectively, and page 86 for classic gauges. We provide temperature strips which may be stuck on any clean, dry, smooth surface. They will record highest temperature reached but are irreversible, see page 25. Use on oil sumps, tanks, filters, coolers. We also offer switches that can be fitted to our adapters to operate warning lights.

## Measuring Oil Pressure And Low Pressure Warnings

All engines have a tapping on an oil gallery to take a no oil pressure warning transmitter, we make a range of T pieces to screw into this tapping. Low oil pressure switches are offered as alternatives to the whoops its too late pressure warning transmitters fitted as original equipment, ours provide a warning when the oil pressure drops below the desired running pressure, they can irritate by actuating a warning when the engine is ticking over but are absolutely essential for spotting signs of trouble in a competition engine.



**MOCAL**

Think Automotive Ltd, Thames House,  
Ashford Road, Middx TW1XB

Part No. **OC5133-8**      manufactured **01/17**

Description:      **13ROW 235mm 1/2 BSP**

*Beware of imitations - if it does not have our label it is likely a copy.*

**Measurements For MOCAL Pressed Plate Coolers**

Construction of this type of cooler is described on page 5. This range of cooler is a direct descendant of the original coolers made by Morris radiators in the 1960's. Made in England from the, slightly updated, original tooling. The secret of the success of the **MOCAL** cooler is an insistence on the highest standards of build quality allied to a rigorous inspection system. In particular the attention paid to the accuracy of the pressing tools to ensure the closest contact of the plates during the "Nocoloc" brazing process ensures superiority over copies from the Far East.

The coolers are available in various heights and two widths, 115mm matrix or 235mm matrix but in common with all their clones only one, 51mm, front to back measurement. The height of a cooler is usually referred to in rows, these are the number of oilways including top and bottom plates which carry oil.

Maximum working pressure on the standard range of coolers is 10 bar (150psi) although each cooler is tested to 11.5 bar (170psi) this is adequate for all but the most arduous motoring applications, however in cold start conditions if too high rpm is used the pressure by pass valve sometimes does not provide enough flow. This will lead to excessive oil pressure, note that some dry sump systems do not even have pressure relief on the return to tank where a cooler is often fitted. To help cope with such problems we have introduced a heavy duty (HD), 12 bar (180psi) working pressure, version of the cooler made in the EU which is dimensionally similar but has aluminium castings between the plates. On the standard cooler this is the weakest point where they are unsupported by fins or turbulators, There is also thicker material in some areas. These coolers are about 18% heavier.

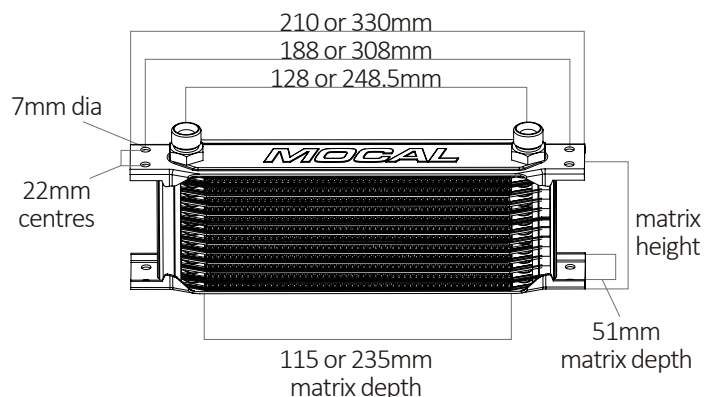

**Part Numbers For MOCAL Pressed Plate Coolers**

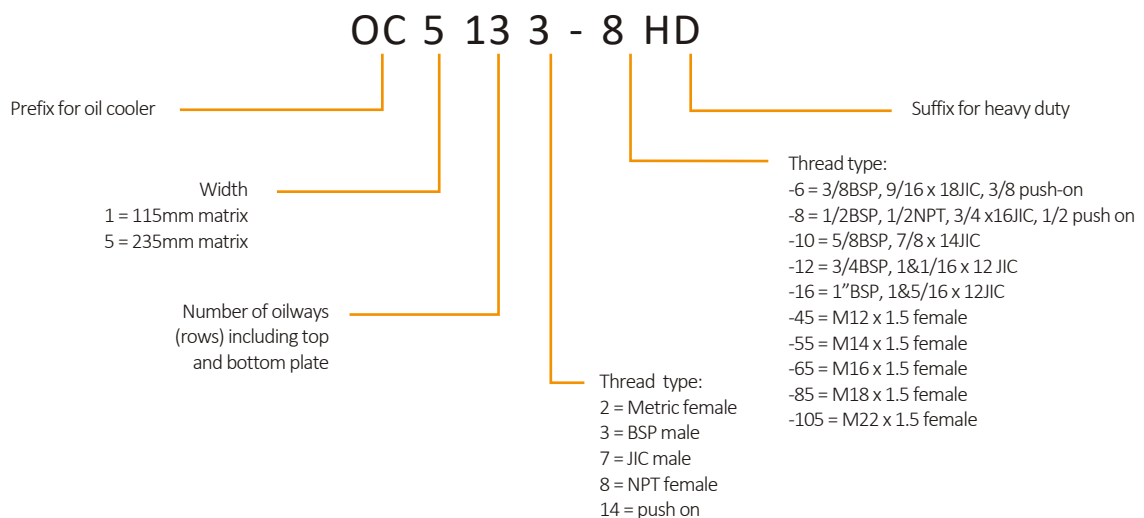



Number of rows	Cat	Height in mm	115mm matrix				235mm matrix			
			Volume in litres		Weight in kgs		Volume in litres		Weight in kgs	
			Standard	HD	Standard	HD	Standard	HD		
7	10	53	0.08	0.31	0.38	0.14	0.53	0.62		
10	10	77	0.12	0.39	0.50	0.20	0.71	0.75		
13	10	100	0.16	0.48	0.63	0.26	0.88	1.06		
16	10	124	0.19	0.60	0.74	0.32	1.06	1.28		
19	10	147	0.23	0.67	0.85	0.38	1.24	1.49		
25	10	194	0.30	0.84	1.07	0.50	1.60	1.94		
34	10	265	0.41	1.15	1.40	0.68	2.14	2.58		
40	10	310	n/a	n/a	n/a	0.80	2.40	n/a		
44	10	344	0.53	1.46	1.91	0.88	2.73	3.27		
50	10	390	0.60	1.63	2.05	1.00	3.09	3.72		
60	10	460	0.70	n/a	2.25	1.30	3.69	4.45		

**MOCAL** standard coolers are now available with low profile M22x1.5 female ports.

The M22x1.5 brazed female hexagon is only 10mm high from the top plate.

These low profile M22 female connectors are available throughout the **MOCAL** standard range. To order use OC\*\*\*2-105 suffix.



## MOCAL Graphs

**MOCAL Oil Pressure Drop**

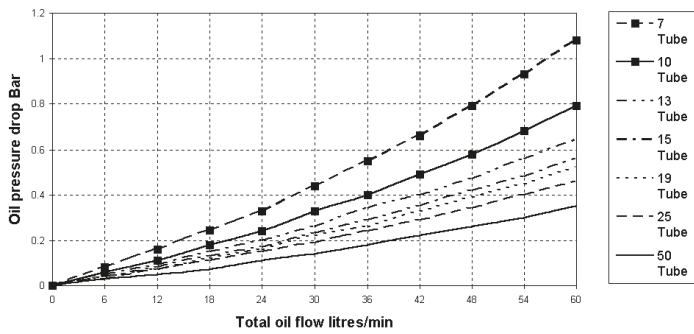

**MOCAL Heat Transfer (I)**

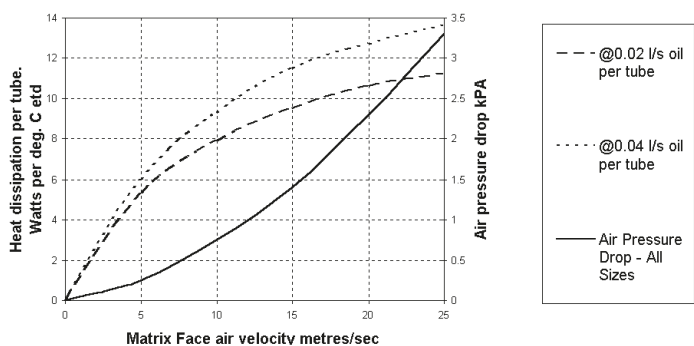

**MOCAL Heat Transfer (II)**

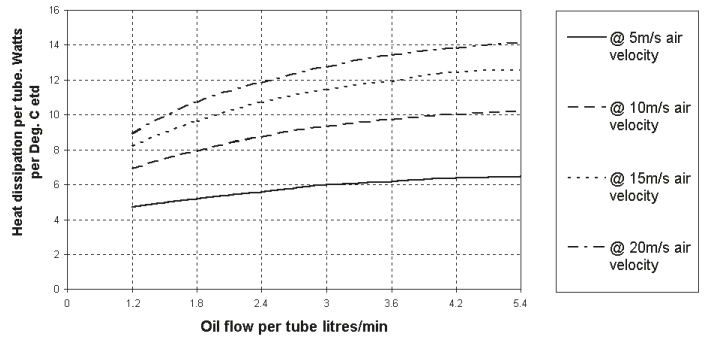

## Interpreting The Graphs

We will take **MOCAL** heat transfer (II) as an example.

1. Calculate oil flow per tube . Usually an unknown, the oil flow through the engine can only be measured using a flow meter.
2. Calculate etd (extreme temperature difference) (Example (Example: 29 litres/min through 16 row cooler => 29 ÷ 16 = 1.8 litre/ min)
 

oil in to cooler at 120°C - Ambient at 25°C => 120 - 25 = 95)
3. State matrix air velocity. Again an unknown depending on cooler position, whether ducted etc, typically, a fifth of the available air would go through the cooler. ( Example road speed 112mph divide by 2.25 to get 50 metres/sec divide by 5 gives 10m/s.m.a.v.)
4. From the graph we find we are dissipating 8.8 watts per tube per °C etd.
5. Calculate total heat dissipated (Example 8.8 x 16 (tubes) x 95 (etd) =13376 watts @ 13.4 kilowatts)
6. Calculate oil out of cooler temperature which is arrived at by deducting the heat dissipated multiplied by a constant of 39 divided by the oil flow rate from oil temperature in to cooler (Example 120 - ( 13.4 x 39 ÷ 29) = 102 °C)

From this we can conclude that in the example given we are reducing the temperature of the oil going to the bearings from 120°C to 102°C. If it seems too complicated please send us the parameters and we will work it out.

Setrab have no graphs available, but do have a comprehensive computer programme to work out individual cases, please give us the parameters and we will provide a print out.

Graphs for oil pressure drop are self explanatory, however please note that the oil in the Laminova graph is at 120°C, the oil in the **MOCAL** is at 100°C and therefore thicker, so meaningful comparisons are difficult.

For KPa to psi, multiply by 0.145.

For bar to psi, multiply by 14.5.

## MOCAL Flat Tube & Fin Oil Coolers

A more versatile range of oil to air oil coolers than our pressed plate coolers but not as cost effective. The construction consists of a number of flattened tubes into which turbulators are slid, these tubes are pushed in to an extruded aluminium housing with finstock fitted between, the whole assembly brazed by the Nocoloc process. Available to special order in 2 tube widths 30mm and 47mm, any length and any height in increments of approximately 10mm per tube, modest tooling charges are involved. Prices on application.



OCSJAG1 - featured on page 12

### Dimensions (mm)

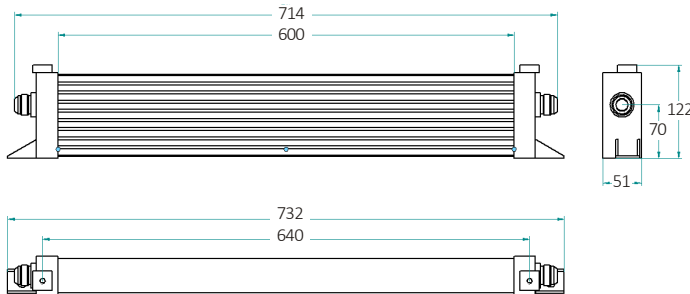

## Setrab Oil Coolers

Setrab are very much orientated to the OEM market which imposes many disciplines in terms of delivery schedules, quality control and environmental issues, following on from their OEM contacts Setrab have enjoyed much success among professional racing teams. We stock and distribute a range of sizes with one M22 x 1.5 female connection size to suit the needs of the aftermarket. This range is called Proline.

### Proline STD Cooler



Construction of this pressed plate type of cooler is described on page 5. They are "Nocoloc" brazed and have a black epoxy finish.

### Dimensions (mm)

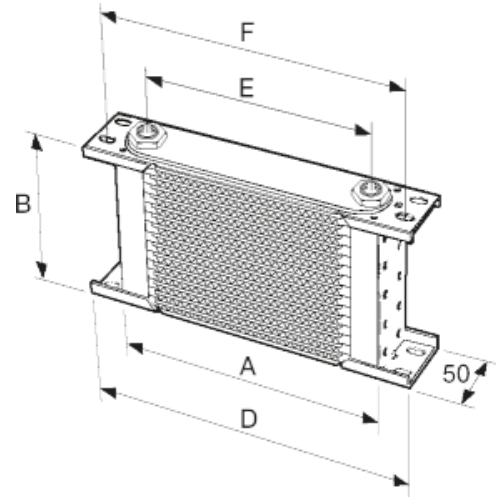

Series	A	D	E	F
1	163	210	130	190
6	283	330	242	310
9	358	405	325	385

### Part Numbers for STD Coolers

Number of rows	Height	Part No Series1	Part No Series 6	Part No Series 9
7	52	50-107-7612	50-607-7612	
10	76	50-110-7612	50-610-7612	50-910-7612
13	99	50-113-7612	50-613-7612	50-913-7612
15	115			50-915-7612
16	122	50-116-7612	50-616-7612	
19	146	50-119-7612	50-619-7612	50-919-7612
25	193	50-125-7612	50-625-7612	50-925-7612
34	264		50-634-7612	50-934-7612
40	310		50-640-7612	
44	342		50-644-7612	
50	389	50-150-7612	50-650-7612	
72	562	50-172-7612		

### Setrab Proline STD Coolers

Part No	Description
50-107-7612	Setrab Proline Series 1 7 Row
50-110-7612	Setrab Proline Series 1 10 Row
50-113-7612	Setrab Proline Series 1 13 Row
50-116-7612	Setrab Proline Series 1 16 Row
50-119-7612	Setrab Proline Series 1 19 Row
50-125-7612	Setrab Proline Series 1 25 Row
50-144-7612	Setrab Proline Series 1 44 Row
50-150-7612	Setrab Proline Series 1 50 Row
50-172-7612	Setrab Proline Series 1 72 Row
50-313-4058	Setrab Proline Series 3 13 Row 5/8BSP
50-607-7612	Setrab Proline Series 6 7 Row
50-610-7612	Setrab Proline Series 6 10 Row
50-613-7612	Setrab Proline Series 6 13 Row
50-616-7612	Setrab Proline Series 6 16 Row
50-619-7612	Setrab Proline Series 6 19 Row
50-625-7612	Setrab Proline Series 6 25 Row
50-634-7612	Setrab Proline Series 6 34 Row
50-640-7612	Setrab Proline Series 6 40 Row
50-644-7612	Setrab Proline Series 6 44 Row
50-650-7612	Setrab Proline Series 6 50 Row
50-907-7612	Setrab Proline Series 9 7 Row
50-910-7612	Setrab Proline Series 9 10 Row
50-913-7612	Setrab Proline Series 9 13 Row
50-915-7612	Setrab Proline Series 9 15 Row
50-919-7612	Setrab Proline Series 9 19 Row
50-925-7612	Setrab Proline Series 9 25 Row
50-934-7612	Setrab Proline Series 9 34 Row

## Proline SLM Slimline Cooler



This has a smaller front of 40mm as opposed to the 50mm of the **MOCAL** and STD coolers. Pressure drop will be higher, they are suited for most oil cooling applications but only the 14 row height should be considered for the higher flows found in engine cooling installations. These tube and fin coolers are “Nocoloc” brazed and have a black epoxy finish.

### Dimensions (mm)

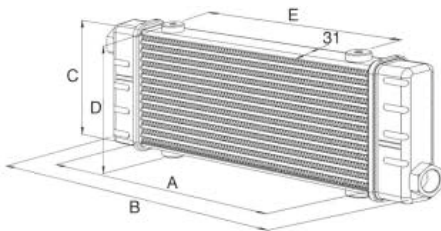

### Part Numbers For SLM Coolers

Part No	Rows	Matrix Width (A)	Cooler Width (B)	Cooler Height (C)	Overall Height (D)	Mount Centres (E)
SLM141-06	6	141	204	52	64	90
SLM141-10	10	141	211	88	100	90
SLM141-14	14	141	211	124	138	90
SLM250-6	6	250	313	52	64	200
SLM250-10	10	250	320	89	103	200
SLM250-14	14	250	320	124	138	200
SLM420-6	6	420	483	53	67	320
SLM420-10	10	420	490	89	103	320
SLM420-14	14	420	490	124	138	320
SLM592-6	6	592	655	53	67	492
SLM592-10	10	592	662	89	103	492
SLM592-14	14	592	662	124	138	492

### Setrab Proline SLM Coolers

Part No	
SLM141-6	Setrab SLM 141mm X 6 Row Cooler
SLM141-10	Setrab SLM 141mm X 10 Row Cooler
SLM141-14	Setrab SLM 141mm X 14 Row Cooler
SLM250-6	Setrab SLM 250mm X 6 Row Cooler
SLM250-10	Setrab SLM 250mm X 10 Row Cooler
SLM250-14	Setrab SLM 250mm X 14 Row Cooler
SLM420-6	Setrab SLM 420mm X 6 Row Cooler
SLM420-10	Setrab SLM 420mm X 10 Row Cooler
SLM420-14	Setrab SLM 420mm X 14 Row Cooler
SLM420-14-M18	Setrab 420-14 M18 Female Top Fit
SLM592-6	Setrab SLM592mm X 6 Row Cooler
SLM592-10	Setrab SLM592mm X 10 Row Cooler
SLM592-14	Setrab SLM592mm X 14 Row Cooler

### Proline Coolers - Performance

We have not included performance graphs. We have a computer system that will predict results on any range, we require oil and air flows together with temperature differentials.

## Low Level High Flow Banjo Adapters

### NEW TO CATALOGUE!

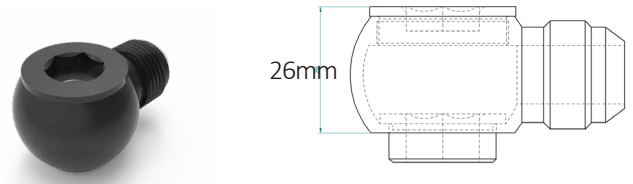

Ideal for where space is limited on top of your oil cooler, these fittings have been innovatively designed to give maximum flow for minimum height.

Part No	
BA7-M22-6HF	Banjo M22 male to -6JIC take off
BA7-M22-8HF	Banjo M22 male to -8JIC take off
BA7-M22-10HF	Banjo M22 male to -10JIC take off
BA7-M22-12HF	Banjo M22 male to -12 JIC take off

## Fittings & Adapters For **MOCAL** M22 Female and Setrab Proline

Part No	
<b>Male To Male Adapters - Includes O-Ring Seal</b>	
MMA2-4-105S	Ali M/M Straight - 4JIC X M22x1.5
MMA2-6-105S	Ali M/M Straight - 6JIC X M22x1.5
MMA2-8-105S	Ali M/M Straight - 8JIC X M22x1.5
MMA2-10-105S	Ali M/M Straight - 10JIC X M22x1.5
MMA2-12-105S	Ali M/M Straight - 12JIC X M22x1.5
MMA2-16-105S	Ali M/M Straight - 16JIC X M22x1.5
MMA5-6-105S	Ali M/M 3/8BSP X M22x1.5
MMA5-8-105S	Ali M/M 1/2BSP X M22x1.5
MMA5-10-105S	Ali M/M 5/8BSP X M22x1.5
MMA5-12-105S	Ali M/M 3/4BSP X M22x1.5
<b>Male To Female Adapters - Includes O-Ring Seal</b>	
MFA2-105-55	Ali M/F M22 X M14
MFA2-105-65	Ali M/F M22 X M16
MFA2-105-85	Ali M/F M22 X M18
<b>Male To Low Pressure Hose Tail Adapters</b>	
MMA14-6-105S	Ali Straight 3/8" Push-On M22
<b>Fittings For Aeroquip Socketless Push On Hose</b>	
HEMAP2-105-6	Ali Male Push Fit M22 For 3/8"
HEMAP2-105-8	Ali Male Push Fit M22 For 1/2"
HEMAP2-105-10	Ali Male Push Fit M22 For 5/8"
HEMAP2-105-12	Ali Male Push Fit M22 For 3/4"
HEMAP42-105-6	Ali Male 45° Push Fit M22 For 3/8"
HEMAP42-105-8	Ali Male 45° Push Fit M22 For 1/2"
HEMAP42-105-10	Ali Male 45° Push Fit M22 For 5/8"
HEMAP42-105-12	Ali Male 45° Push Fit M22 For 3/4"
HEMAP92-105-6	Ali Male 90° Push Fit M22 For 3/8"
HEMAP92-105-8	Ali Male 90° Push Fit M22 For 1/2"
HEMAP92-105-10	Ali Male 90° Push Fit M22 For 5/8"
HEMAP92-105-12	Ali Male 90° Push Fit M22 For 3/4"
<b>Fittings For Aeroquip Style Hose</b>	
HEMA2-105-6	Ali Straight M22 Male For FBA0600
HEMA2-105-8	Ali Straight M22 Male For FBA0800
HEMA2-105-12	Ali Straight M22 Male For FBA1200
HEMA2-105-10	Ali Straight M22 Male For FBA1000
HEMA42-105-6	Ali 45° M22 Male For FBA0600
HEMA42-105-8	Ali 45° M22 Male For FBA0800
HEMA42-105-10	Ali 45° M22 Male For FBA1000
HEMA42-105-12	Ali 45° M22 Male For FBA1200
HEMA92-105-6	Ali 90° M22 Male For FBA0600
HEMA92-105-8	Ali 90° M22 Male For FBA0800
HEMA92-105-10	Ali 90° M22 Male For FBA1000
HEMA92-105-12	Ali 90° M22 Male For FBA1200
<b>Jiffy-Tite Quick Connect Fluid Fittings</b>	
JT521222	J/T Plug M22x1.5 Male Valved
JT52122D	J/T Plug 45° M22 Male Valved
JT52122E	J/T Plug 90° M22 Male Valved

For the full range of Jiffy-tite see page 69.

## PWR 37mm Engine, Transmission & Power Steering Coolers



An aluminium pressed plate oil cooler constructed along similar lines to the **MOCAL** and Setrab cooler but with only 37mm depth. The top and bottom plates are not fluid carrying. Despite its smaller depth, performance is very competitive with **MOCAL** and Setrab coolers of comparable frontal area, although oil pressure drops are higher. Supplied with 7/8 x 14 (-10) UNF female threads. For adapters see page 54 onwards. Very nicely finished in glossy black.

### Dimensions

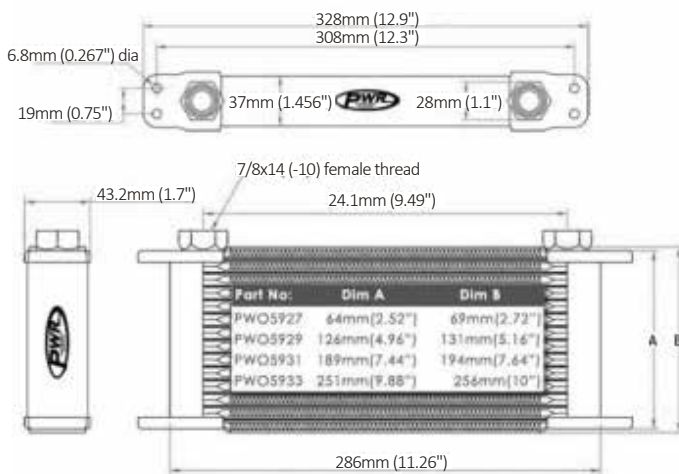

### Part No

PW05927	PWR Cooler 7 Row 37mm
PW05929	PWR Cooler 14Row 37mm
PW05931	PWR Cooler 21.Row 37mm
PW05933	PWR Cooler 30 Row 37mm

## PWR 19mm Transmission & Power Steering Coolers



The PWR range of 19mm deep coolers is of aluminium pressed plate construction, they are configured to suit cooling systems powered by electric remote pumps with their lower oil flows than engine driven pumps. Compared to our range of 50mm deep coolers their

narrower oil passages offer higher oil flow resistance but this is of little importance due to the low oil flows involved; bearing in mind that the main, higher viscosity transmission oils, often used in these installations, should not be pumped until at least 100°C is reached. Their 19mm depth offers less resistance to air flow, useful where the cooler is not sited in the most favourable position.

The performance of these transmission coolers would equate to a 50mm cooler 20% smaller in height but offer less bulk to package, less weight and operate more efficiently at smaller air flows. Supplied with -6JIC male threads. They are unpainted with a natural silver finish.

### Dimensions

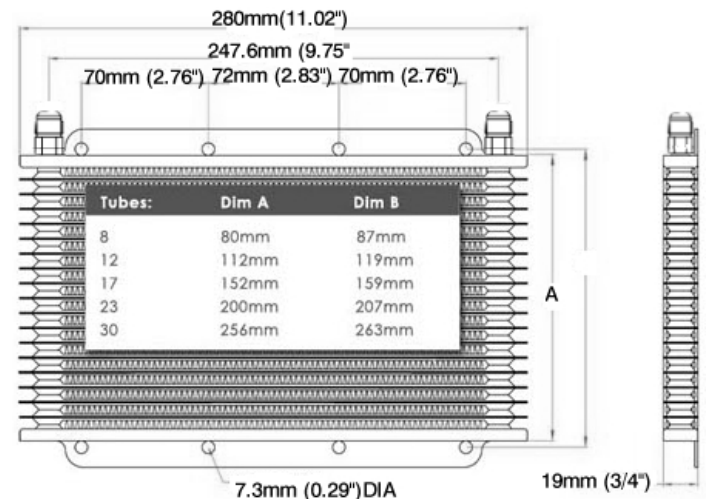

### Part No

OCP87-6	PWR Cooler 8 Row 19mm
OCP127-6	PWR Cooler 12 Row 19mm
OCP177-6	PWR Cooler 17 Row 19mm
OCP237-6	PWR Cooler 23 Row 19mm
OCP307-6	PWR Cooler 30 Row 19mm

## Original Equipment or replacement Oil Coolers



We stock some coolers fitted as original equipment.

### Part No

OC5133-8	BMC Mini-Cooper
OC5103-6	BMC Princess 3Ltr
OCSBEN1	Bentley Turbo R (UE75191)
OC5161-12	Jaguar XJ6 Series 3
OC5191-12	Jaguar XJS 3.6
OCSJAG1	Jaguar XJS V12
OC5133-10	Jensen Healey
OC1193-8	MG Metro
OC5133-8	MG A/B
OC5133-6	MG C Automatic - Transmission Cooler
OC5103-8	MG C Automatic - Engine Cooler
OC573-8	Austin/Rover Sherpa Diesel
OC1163-10	Lotus Esprit
OCSLOT2	Lotus Carlton
OCSLOT3	Lotus Elise With Toyota Engine L/H
OCSLOT4	Lotus Elise With Toyota Engine R/H
OC5103-6	Saab Turbo 99
OC1162-55	Saab Turbo 900

## Nissan GTR R35 Oil Cooler

**NEW TO CATALOGUE!**



Featuring a 10mm thicker core with the benefit of two extra rows of cooling, this is designed to be a direct replacement for the original equipment oil cooler.

### Dimensions

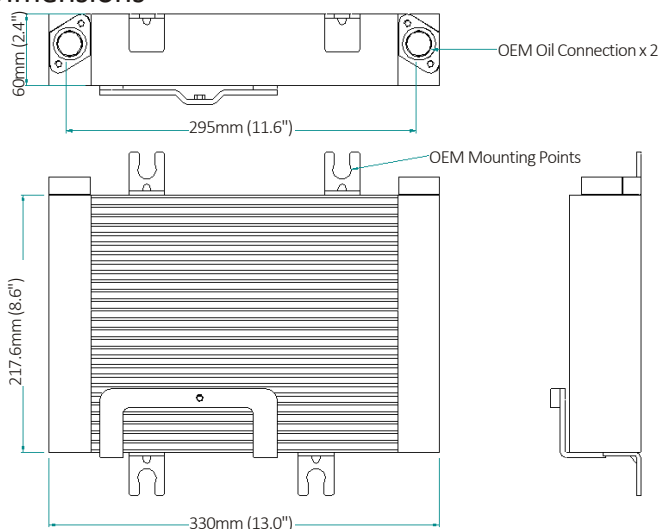

Part No  
OCSNIS1 GTR Oil replacement cooler

## Oil Cooler Mounting Bracket

A. Pairs of pre drilled universal brackets to facilitate the mounting of **MOCAL** and Setrab coolers.

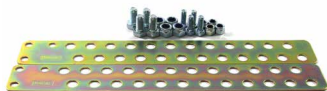

B. Bracket to allow the fitment of a Spal 115mm fan to **MOCAL** 115mm 19row cooler. Double bracket also available to allow 2 fans to be fitted to the **MOCAL** 235 cooler. Fan sold separately, see page 87 for more details. Other fan brackets in development, please enquire.

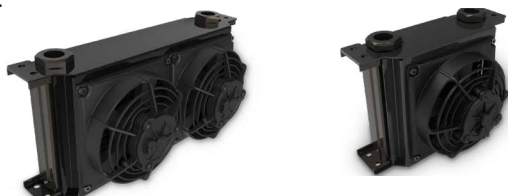

C. Pair of **MOCAL** aluminium brackets available for standard **MOCAL** coolers, will also fit Setrab coolers, allows fitting to a horizontal structure, includes bolts and tapped fittings with rubber pads.



D. Nylon ties that pass through the finning to mount cooler or fan directly to the face of a radiator. This is hardly recommended engineering practice but we have had no problems.



E. Double or single rubber mount suits **MOCAL** & Setrab, single for others.



### NEW TO CATALOGUE!

F. Pair of aluminium brackets available for 13, 16 and 19 row oil coolers to enable fitting to a vertical structure, they can be trimmed to turn through 90°



Part No	Description
BRKT1	Universal Oil Cooler Brackets (Pair) - A
BRKT3	Fan Housing For 16 Row 115mm - B
BRKT6	Double Fan Housing For 16 Row 235mm - B
BRKT8	Fan housing for 19 row 115mm - B
BRKT9	Fan housing for 19 row 235mm - B
BRKT13	Suitable for 13 row 115/235mm - F
BRKT16	Suitable for 16 row 115/235mm - F
BRKT19	Suitable for 19 row 115/235mm - F
BRKT-350	Cooler Bracket for Nissan 350X
FAN11912	Fan-119Mm Square - 12V To Fit BRKT3 & 6
FAN115S	Spal 12V fan to suit BRKT8 & BRKT9 (suck) - B
FAN115B	Spal 12V fan to suit BRKT8 & BRKT9 (blow) - B
262	Bracket for Cooler Universal
25-932	Brackets For Series 1 (115mm) Coolers - C
25-933	Brackets For Series 6 (235mm) Coolers - C
25-934	Brackets For Series 9 (330mm) Coolers - C
QFK1	Fan/Cooler Quick Fit Kit - D
DCQFK	Nylon Ties For Through Radiator Mounting - D
OCRM-1	Oil Cooler Single Rubber Mount - E
OCRM-2	Oil Cooler Double Rubber Mount - E

## Oil Cooler Ducts



High quality oil cooling air ducts have been specifically designed to mount quickly and easily to 13, 16 or 19 row **MOCAL** or Setrab type oil coolers. Supplied with laser cut aluminium mounting brackets and all fittings. The main body is formed from HDPE. Stepped inlet to accommodate two sizes of ducting 63/76mm on 13 & 16 row. 19 row duct designed with double inlet 76/63mm. Only for 235mm/series 6 matrix coolers. Oil cooler not included.

Part No	Description
OCD13	Duct For 13 Row Oil Cooler C/W Bracket And Fixing
OCD16	Duct For 16 Row Oil Cooler C/W Bracket And Fixing
OCD19	Duct For 19 Row Oil Cooler C/W Bracket And Fixing

# laminova Oil Coolers

## C43 Engine & Transmission Oil Coolers



### Construction:

Case and core of extruded and machined aluminium sealed with O-rings and gaskets. When fully assembled have a working pressure of 30bar.

Waterside connections for 16mm, 18mm, 24mm, 28mm, 32mm straight and 90°, 35mm, 38mm, 45mm bore hoses also -16, -20 and -24 SAE 37° (JIC) threaded unions.

Oilside male connections for -6, -8, -10, -12 and -16 SAE 37° (JIC), M16x1.5 female, others to special order.

### Application:

We have 2 installation kits that use part no C43-18078-M32. For all others, see page 6 "installing a cooler" & "laminova".

Kits do not include the cooler.

### Recommended sizes:

It is difficult to come up with meaningful performance figures as these are dependent upon oil and water flow, figures that are rarely known, A C43-90 would give a similar performance to a 10 row air to oil cooler, a C43-180 a 16 row and a C43-330 to a 25 row. Other sizes are available, please enquire.

### Part No

LOICAT1	Installation For Caterham With Apollo Tanks
LOILOT1S	Installation For Lotus Elise - Stainless Hoses

## Dimensions (mm)

(approximate, lengths will vary with fittings)

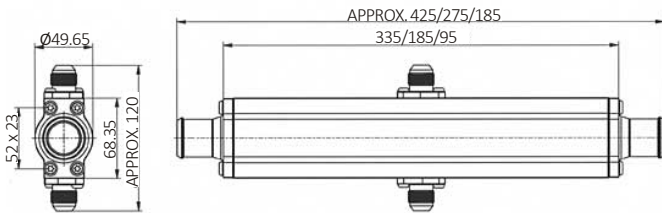

## C43 Performance Graphs

laminova Heat Transfer- 180

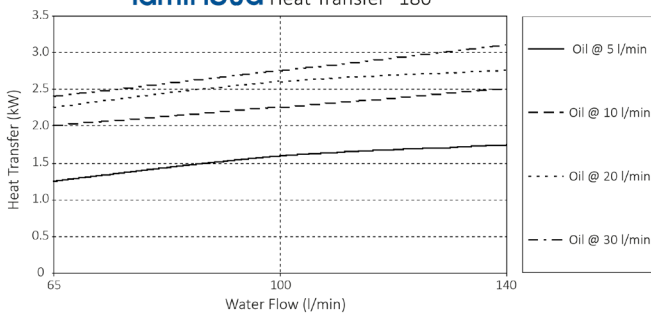

laminova Heat Transfer- 180

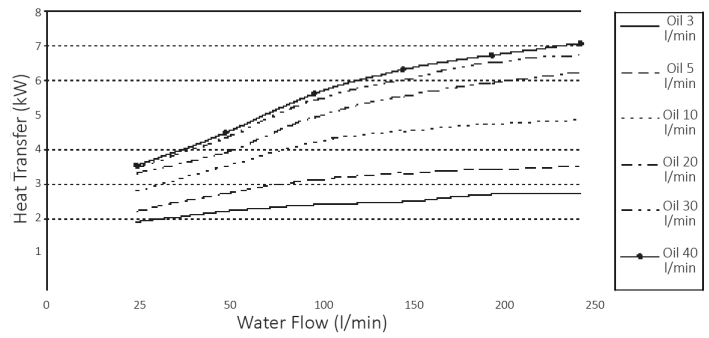

laminova Heat Transfer- 180

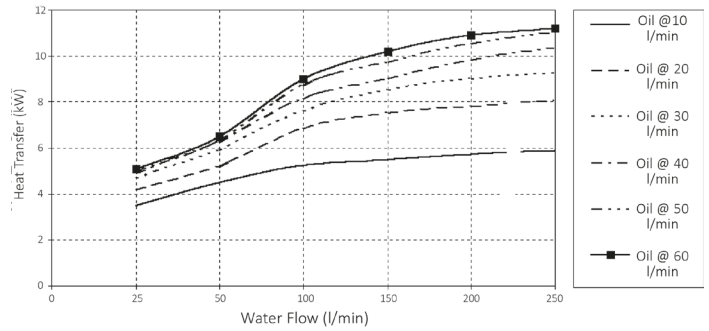

laminova Oil Pressure Drop

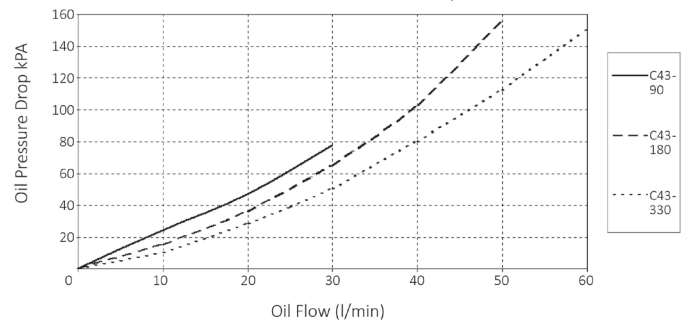

LWT-43



LWP-43

### Part No (Excluding Connectors)

C43-90	Laminova Oil Cooler Approximately 185mm Overall
C43-180	Laminova Oil Cooler Approximately 275mm Overall
C43-330	Laminova Oil Cooler Approximately 425mm Overall

Water restrictors can also be added

LWP-43	Full Water Restrictor
LWT-43	Partial Water Restrictor

JIC water connectors are also available.

Choose oil and water connectors to match your application.

The part number represents the core diameter and length suffixed by the oil then water connector size. Some common part numbers include:

### Part No

C43-9076-M18	C43 Core 90mm Long -6JIC/M18
C43-9078-M28	C43 Core 90mm Long -8JIC/M28
C43-90710-M32	C43 Core 90mm Long -10JIC/M32
C43-90716-M45	C43 Core 90mm Long -16JIC/M45
C43-18078-M32	C43 Core 180mm Long -8JIC/M32
C43-180710-M38	C43 Core 180mm Long -10JIC/M38
C43-180712-M45	C43 Core 180mm Long -12JIC/M45
C43-180716-M45	C43 Core 180mm Long -16JIC/M45
C43-330710-M32	C43 Core 330mm Long -10JIC/M32
C43-330710-M38	C43 Core 330mm Long -10JIC/M38
C43-330712-M38	C43 Core 330mm Long -12JIC/M38
C43-330716-M45	C43 Core 330mm Long -16JIC/M45

Any combination is possible using the standard oil and water connectors

## C43 Connectors, Service Kits & Brackets

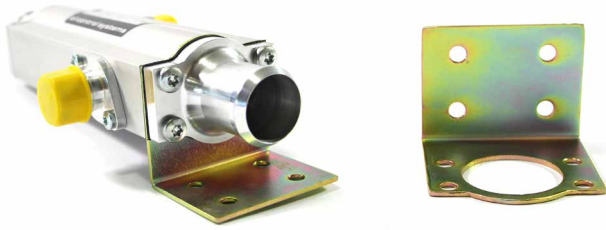

Part No	
LOC7-6	C43 Oil Connector -6JIC Male
LOC7-8	C43 Oil Connector -8JIC Male
LOC7-10	C43 Oil Connector -10JIC Male
LOC7-12	C43 Oil Connector -12JIC Male
LOC7-16	C43 Oil Connector -16JIC Male
LWC-M16	C43 Water Connector M16 O.D. Tail
LWC-M18	C43 Water Connector M18 O.D. Tail
LWC-M24	C43 Water Connector M24 O.D. Tail
LWC-M28	C43 Water Connector M28 O.D. Tail
LWC-M32	C43 Water Connector M32 O.D. Tail
LWC-M35	C43 Water Connector M35 O.D. Tail
LWC-M38	C43 Water Connector M38 O.D. Tail
LWC-M45	C43 Water Connector M45 O.D. Tail
LWC7-16	C43 Water Connector -16JIC
LWC7-20	C43 Water Connector -20JIC
LWC7-24	C43 Water Connector -24JIC
Service kit is available with gaskets, o-rings and screws	
LSK1	C43 Service Kit
C43B1	C43 Brackets Pair

More available on request

## S34 Small Engine, Transmission & Power Steering Coolers



Waterside connections for 16, 24mm bore hose, oilside -6JIC or 1/2 push on. Please enquire for S34-194 performance graph.

### Dimensions of S34-194 (mm) (approximate, will vary with fitting size)

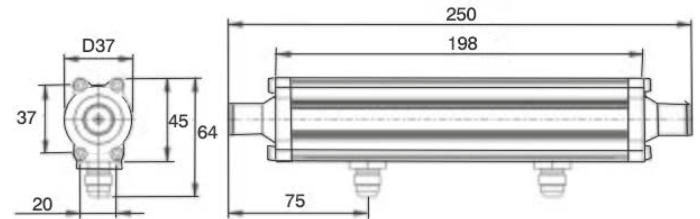

Part No	
S34-19476-M16	Overall Size 250Mm With 16mm Water Connection
S34-19476-M24	Overall Size 250Mm With 24mm Water Connection

## C43 Combined Engine/Transmission Cooler.



A bolt on extra for any of the C43 range of oil coolers as highlighted in the image. This creates an additional cooler section that can be used for gearbox or differential cooling by attaching a C43-90 section. These can be ordered as complete units or as a bolt on extra with -6JIC fittings.

Part No	
C43-9076-AO	C43 core 90mm Long -6JIC/Add On

## Special laminova Applications

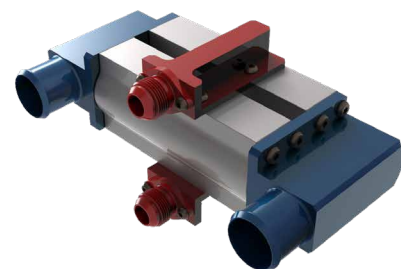

Due to the exchangers' compact size and flexible mounting possibilities, the **laminova** cooling cores are suitable for a huge range of applications. Our design team is happy to work with end users to arrive at the best possible solution for heat exchange on land, at sea and in the air.



## Laminova ECD54 Engine Oil Coolers



Provides engine oil cooling for more demanding applications. Construction is similar to C43 range except oil outlets are parallel not on opposite sides. Available with twin oil side cores, one fitted inside the other. Heat transfer for the twin core example is almost double the C43-330. Currently available with oilside connections in -8, -10, -12 & -16 SAE 37°(JIC) and waterside to take 28, 32, 35, 38 and 45mm bore hose.

**Dimensions (mm)** (approximate, may vary with fitting size)

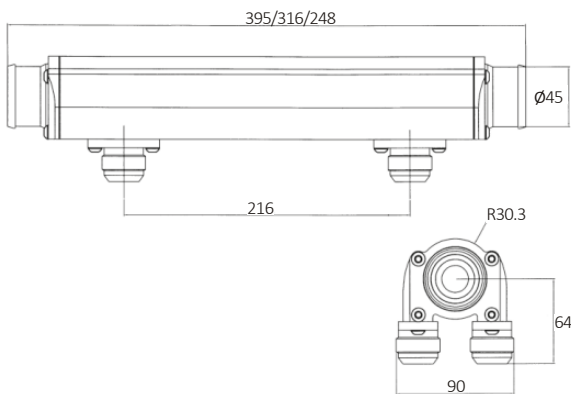

### ECD54 Twin Core Performance Graphs

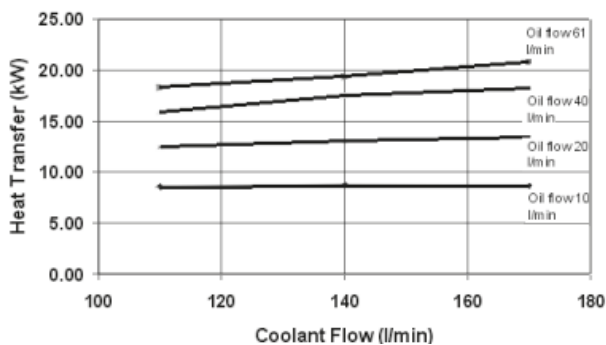

OIL PRESSURE DROP ECD54-329

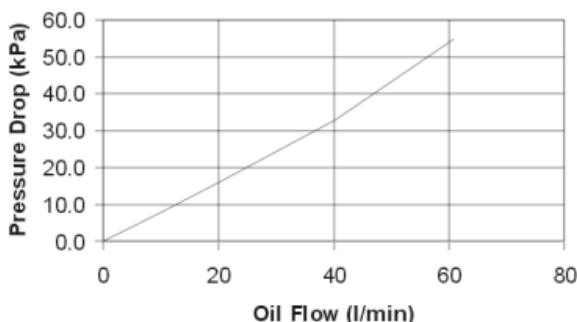

Part No	
ECD54-182	248mm overall Double Core
ECD54-250	316mm Overall Double Core
ECD54-329	395mm Overall Double Core
ECD54SK	Service Kit For EC54/ECD54
ECB1	EC/ECD Brackets Pair

Please suffix your required oil and water connectors for full ECD part numbers.

## ECD54 Engine/Transmission Oil Coolers



A combined unit for engine & gearbox or gearbox & differential cooling. Available with Male JIC 6, JIC 8, JIC 10, JIC 12, JIC 16 and female M26x1,5 oil connections. Male 28mm, 32mm, 35mm, 38mm, 45mm and 50mm water connections.

**Dimensions (mm)**

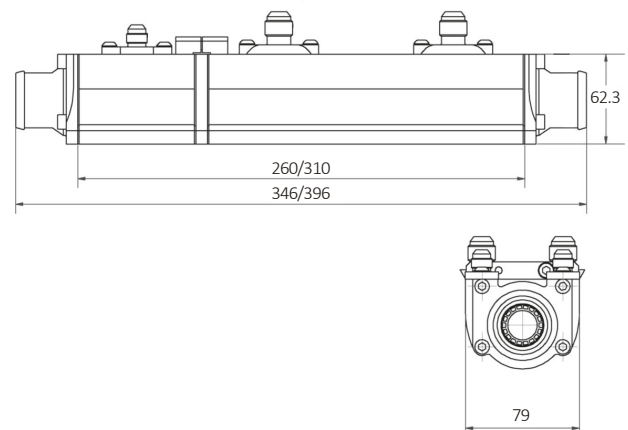

## Laminova Coolers: Interpreting The Graphs

We show separate heat transfer graphs for each size of cooler. For comparison purposes we have taken similar figures to those used in the pressed plate cooler examples. However we have a different sort of etd (extreme temperature difference), these graphs are based on an etd of 35°C e.g. oil in at 120°C, water in at 85°C.

1. Look up total heat dissipated. Looking at the 330mm cooler at an oil flow of 30 litres/min, assuming a water flow of 150 litres/min we have a heat dissipated of 10 Kw.
2. Calculate Oil temperature out of cooler. This is arrived at by multiplying the heat dissipated by a constant of 39, then divide by the oil flow rate and deduct this from temperature of the oil in to the cooler. (Example  $120 - (10 \times 39 \div 30) = 107^\circ\text{C}$ )

Graphs for oil pressure drop are self explanatory, however please note that the oil in the Laminova graph is at 120°C, the oil in the **MOCAL** is at 100°C and therefore thicker, so meaningful comparisons are difficult.

KPa to psi multiply by 0.145  
Bar to psi multiply by 14.5

Part No	
CETC712/8-M38	Combined Cooler -8 & -6JIC Oil M32 Water 346mm
CETC712/8-M32	Combined Cooler -12 & -8JIC Oil M32 Water 346mm
CET54378/6-M38	Combined Cooler -8 & -6JIC Oil M38 Water 396mm
CET543710/6-M32	Combined Cooler -10 & -6JIC Oil M32 Water 396mm

Other connector combinations available on request.



## Engine Oil Cooler Installation Kits



Application: In the following pages are various components that we manufacture to enable all types of oil coolers to be fitted to any vehicle. We are able to supply complete installation kits for fitting **MOCAL** coolers not included in kit to production cars, part numbers for the more popular kits are shown in the separate price list, no vehicle is impossible provided we can find an example to measure, please ask if a model is not listed.

**Hose Type** - In the kits we use a top quality textile braided elastomer (a type of black rubber) covered hose with factory swaged on BSP fittings, we also offer these hoses with a stainless steel braid covering where enhanced appearance and extra abrasion resistance is required. Hose bore is 1/2", where we feel that oil flow could be restricted we use 5/8".

**Oilstats** - If a spin off oil filter is used then the kit can incorporate a built in oil stat , if the car has a disposable element filter then the oilstat must be ordered separately and inserted into a suitable section of hose run after installation, where braided covering has been specified then to avoid frayed ends at the oilstat use suitable Proclamps, part no HF-10 for 1/2", HF-12 for 5/8".

**Cooler size** - We recommend a 10 row cooler for most cars under 2 litres or a 13 row for larger capacity engines. Kits marked \* need coolers with 5/8 BSP connections. Kits with (T) are available with built in or in line oilstats. Oil cooler sold separately. For Stainless braid hoses add 'S' suffix to part number.

### Part No

OCI40	Alfa 4 Cyl Rear Drive Pre 1972
OCI41	Alfa 4 Cyl Rear Drive Post 1972
OCI42	Alfa Alfetta (T)
OCI43	Alfa Alfasud (T)
OCIALF147	Alfa Romeo 147 (T)
OCIALF156	Alfa Romeo 156 (T)
OCI44	Audi 80 (T)
OCI45	BMC Mini/Minicooper - Carburetor
OCI/46	BMC Mini Clubman 1100/1300
OCI53	BMC Healey 100-6/3000
OCI52	BMC Sprite/Midget Pre 1974
OCI51	BMC Midget 1500 (T)
OCI58	BMC Metro
OCI54	BMC MGA/B
OCI60	BMW 4Cyl Post 1963 *(T)
OCI1179	BMW 6Cyl Pre 2.3Ltr *(T)
OCI300	BMW Mini Copper S - Early Supercharged Model
OCI964	Caterham Super 7 1981-83 (T)
OCI1287	Caterham Super 7 1983 (10X115 Cooler)(T)
LOICAT1	Caterham K Series See Laminova Page 7
OCI151	Chevrolet Camaro V8 *(T)
OCI1000	Chevrolet Corvette *(T)
OCI1829	Colt Shogun *(T)
OCI887	Colt 1200/1300/1400 Fwd Hatchback (T)
OCI63	Colt 2000 Rear Wheel Drive (T)
OCI2501	Citroen Ax (T)
OCI2502	Citroen Saxo Vtr/S (T)
OCI68	Datsun 140Z/260Z/240K/260C (T)
OCI71	Fiat 127 (T)
OCI69	Fiat 4Cyl Rwd (T)
OCI73	Fiat Ritmo/Strada (T)
OCI72	Fiat X-19 (T)
OCI2500	Fiat Tipo (T)
OCI2423	Fiat Uno Turbo (T)
OCI77	Ford Ang/Esct/Ctna Pre 1971
OCI76	Ford Capri 2.8i *
OCI78	Ford Esct 1300/1600 Ohv Post 1971 (T)
OCI1204	Ford Escort Mk3 (T)
OCI74	Ford Fiesta (T)
OCI150	Ford Mustang V8 *(T)
OCI2392	Ford Mondeo- Zetec (T)

OCI75	Ford RS2000 *(T)
OCI76	Ford V4/V6 German Eng. *(T)
OCI80	Ford V4/V6 Uk Eng Not Pas *(T)
OCI81	Ford V4/V6 Uk Eng With Pas *(T)
OCI2391	Ford Sierra Cosworth *(T)
OCI1283	Ford XR3
OCI82	Honda Civic
OCI83	Honda Accord/Prelude (T)
OCI2421	Honda CRX (T)
OCI2425	Honda Civic V-Tec (T)
OCI2427	Honda Civic Type R 2Ltr. (T)
OCI86	Lada All Models (T)
OCI87	Lancia Beta/Spyder/HPE (T)
OCI89	Lotus Elan Post 1971 (T)
OCI91	Lotus 7 Post 1971
OCI1037	Lotus Esprit
OCI92	Lotus Europa Ford Eng. (T)
OCI93	Lotus Europa Renault Eng
LOILOT15	Lotus Elise Except Below
OCI998	Mazda 323 (T)
OCI1251	Mazda MX5
OCI1879	Mercedes 190 *(T)
OCI98	MG Late TC Early TD
OCI99	MG Late TD/TF
MGA1	MGA Kit Has OEM Style Steel Tubes
OCI1205	MG Metro
OCI96	Morgan Plus 8 Pre SD1 Engine *(T)
OCI97	Morgan Plus 8 With SD1 Engine *(T)
OCI94	Morgan 4/4 (T)
OCI95	Morgan Plus 4
OCI2436	Nissan Patrol (T)
OCITNIS1	Nissan Skyline In Aeroquip-OT2-RFH Use Oc5167-10
NOR1R	Nissan Sunny GTiR Top Mounted
NOR2R	Nissan Sunny GTiR Front Mounted
OCI104	Opel Manta/Ascona Before 1981 (T)
OCI1511	Opel Manta Post 1981 (T)
OCI1824	Peugeot 106 1.6 Gti (T)
OCI1396	Peugeot 205 Not Gti (T)
OCI1828	Peugeot 205 Gti (T)
OCI2594	Peugeot 306 (T)
OCI1540	Porsche 924 (T)
OCI109	Reliant Scimitar 3 Ltr *(T)
OCI110	Reliant Scimitar 2.8 Ltr *(T)
OCI111	Renault 5 (T)
OCI999	Renault 18 Turbo (T)
OCI2420	Renault Clio (T)
OCI2426	Renault Clio 2.Ltr. 16V
OCI45E	Rover Mini With Injection Pre 1992
OCI45I	Rover Mini With Injection Post 1992
OCI118	Rover Range Rover *(T)
OCI119	Rover 3500 SD1*(T)
OCI122	Saab 99 2 Ltr (T)
OCI128	Skoda S110 (T)
OCI124	Subaru 1600 (T)
OCI2595	Subaru Impreza RFH Kit*
OCI127	Sunbeam Lotus
OCI2435	Suzuki Swift (T)
OCI997	Toyota Corolla RWD(T)
OCI2422	Toyota Corolla FWD (T)
OCI129	Toyota Carina/Celica (T)
OCI1201	Toyota Starlet (T)
OCI130	Triumph Herald/Spitfire (T)
OCI131	Triumph Vitesse/GT6 Rhd
OCI132	Triumph TR2/3/4a
OCI133	Triumph 2000/2.5 Pi
OCI134	Triumph TR5/6
OCI135	Triumph GT6 lhd
OCI136	Triumph Dolomite
OCI137	Triumph TR7
OCI1230	Triumph TR5/6 Spin Off
OCI1382	Vauxhall Astra 1800 & GTE
OCI138	Vauxhall Chvt/Viva/Frza Ohv
OCI141	Vauxhall Chvt/Vva/Frza Mgm Ohc (T)
OCI142	Vauxhall Cavalier Pre 1981 (T)
OCI1511	Vauxhall Cavalier Post 1981 (T)
OCI146	Volkswagen Beetle
OCI147	Volkswagen Beetle Kit With Remote Filter
OCI148	Volkswagen Golf (T)
OCI149	Volkswagen Scirocco (T)
OCI1490	Volkswagen Corrado V6
OCIVWG40	Volkswagen Polo G40 (T)
OCI143	Volvo 4 Cyl Not 66/343 (T)
OCI144	Volvo 6 Cyl

Other kits are available or can be made to your specification.

## Automatic Transmission



Automatic transmission oil cooler kits are designed for fitting an oil cooler behind the front grille usually in front of the water radiator, brackets are provided to enable the use of the water radiator mounting bolts to secure the cooler. Kits come complete with a cooler, textile braided hose plus all the necessary clamps, nuts, bolts etc.

Part No	
AT/2D	Supplementary To Existing Cooler 5/16in Hoses
AT/2	Supplementary To Existing Cooler 3/8in Hoses
AT/2C	Supp. To Existing Cooler 1/2in Hoses For BMW
AT/6	For FX 44 Taxi Cab
AT/7	For Borg Warner 35/65 With Loop Pipe
AT/8	For Volvo 240
OT/1BHT	95°C Oilstat - Option On All Kits

## Oilstats

Usage. See page 7. The bodies of the remote mounted oilstats are machined die cast aluminium or billet. Temperature is controlled by a wax filled element a mass produced unit, subject to the most stringent quality controls. Opening is 80°C specials are available

The remote oilstats are light enough for the hoses to support them without sagging, however a bracket is supplied with the slightly heavier OT/2 if further restraint is required. The OT/1 is supplied with push on fittings for 3/8" or 1/2" bore hose only. The OT/2 can be supplied with any form of push on or threaded connection, male or female.



The oilstats should only be used where oil cooling is adequate. The wax element will suffer permanent damage above 140°C. Replacements are available.

Built in oilstats in oil cooler take off plates are available for any spin on filter engine, they add nothing to the thickness of the plate. For fitting chart see page 20.

## Dimensions

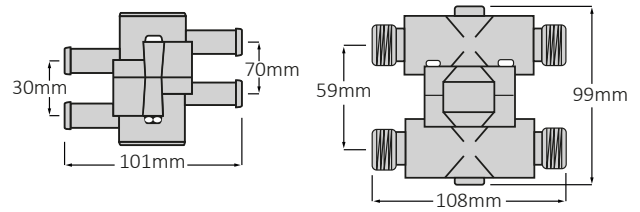

Part No	
OT/1	Oilstat 1/2in Push On
OT/1-92	Oilstat 1/2in Push-On With 92-104 Element
OT/1B	Oilstat 3/8in Push On
OT/2	Oilstat 5/8in Push On
OT/2A	Oilstat 1/2 BSP Female
OT/2B	Oilstat 1/2 NPTF Female
OT/2C	Oilstat 1/2 BSP Male
OT/2D	Oilstat 5/8 BSP Male
OT/2E	Oilstat 3/4 BSP Male
OT/2F	Oilstat -8JIC Male
OT/2G	Oilstat -10JIC Male
OT/2H	Oilstat -12JIC Male
OT/2J	Oilstat -16JIC Male
OT/2M	Oilstat M22 Female
OT/2K	Oilstat 3/4in Push On
OT/2SK	OT2 Oilstat Service Kit With 72° Element
OT/2SK92	OT2 Oilstat Service Kit With 92° Element
OTGM7-8	Oilstat GM LS Engines -8JIC (Type H) see page 18
OTGM7-10	Oilstat GM LS Engines -10JIC (Type H)
OTGM7-12	Oilstat GM LS Engines -12JIC (Type H)

## Billet Oilstat NEW TO CATALOGUE!



A new lightweight billet oilstat designed around the OT/2 concept to offer high flow in a compact form. Has M22 ports so can be used in conjunction with fittings featured on Page 11.

## Dimensions

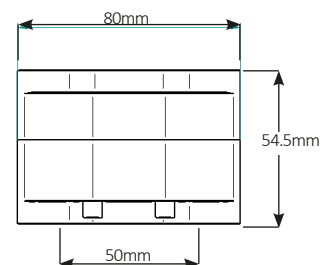

Part No	
OT/4	Billet Oilstat M22 female

## Oil Cooler Take-Offs

Any engine fitted with a full flow oil filter may use an attachment to take an oil cooler. This is achieved in various ways.

**Type A** A sandwich plate fitted between filter head and filter bowl. If there is insufficient room to accommodate the sandwich plate, there is a large range of shorter or narrower filter cartridges available, we can advise. Most vehicles use a spin on oil filter cartridge, our SP1 range fits these, accommodating the minor variations in sealing ring diameter and by use of differently threaded centre bolts (extension screws).

SP1 range (Type A)



OTSP2



SP6 (Type A)



SP16 (Type A)

**NEW TO CATALOGUE!**



OTSP1HF (Type A)



SPA1 (spacer for Toyota/ Subaru engine)



SP100 (Type A)



OTSP16 (Type A)

**NEW TO CATALOGUE!**



Variations of the SP1 are the OTSP1 with built in thermostatic control the TGASP1 with a tapping for temperature gauge, the SP100 made from billet which fits the Japanese micro filter and the OTSP1HF a thermostatic plate which although bulkier and more expensive offers minimum flow obstruction.

A spacer SPA1 plus longer extension screws is available, it is useful on certain applications. E.g. 1600cc Mk1 Mazda MX-5 or the new Toyota GT86.

Our new SP100 has M22 ports and 2 x 1/8NPT plugged ports for temp/pressure gauge or turbo feed.

**Type B** A sandwich plate between the filter assembly and cylinder block.

SP14



SP15



SP9



**Type C** In the case of BMCA and B series engines an external oil pipe may be removed and replaced with hoses running to and from the oil cooler. A series have 1/4 NPTF & 5/8 UNF use HEM8-4-8 & HEM1-7-8 hose ends or suitable adapters. B series have 1/2BSP threads, use suitable adapters. (not illustrated)

**Type D** For the 6 Cylinder Triumph engines where there is not enough room to fit a Type A plate, we provide an adapter turning the filter through 90°. For convenience this takes a spin on oil filter.

FH3



FH5



**Type F** A plate designed to replace existing oil/water heat exchangers to allow remote mounting of a more efficient oil cooler, some are available as Thermostatic.

TOP3



TOP17



TOP21 **NEW TO CATALOGUE!**

TOP24 **NEW TO CATALOGUE!**



TOP24T **NEW TO CATALOGUE!**

TOP29 **NEW TO CATALOGUE!**



TOP26 **NEW TO CATALOGUE!**



**Type G** The Volkswagen Beetle and Porsche derivatives have an oil cooler fitted to the engine as standard. This will be insufficient for modified engines and also blocks the air flow to number 4 cylinder. We provide an adapter to fit in place of the existing cooler with 3/8NPTF connections to cooler. Consideration may be given to fitting a remote oil filter in the cooler circuit, the original engine having no filter, we advise fitting a part number 500 valve in place of the original combined oil pressure relief and cooler bypass valve. This ensures oil flow through the filter at all times. An oilstat can be used to control flow to the cooler.

TOP27

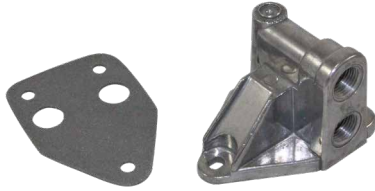

**Type H** Some engines have a cover plate, which may be removed and replaced with a special take off.

TOP7 (Type H)



OTGM (Type H)



**Type I** Plate fits in place of existing filter assembly, use with a remote filter. For 4 cylinder BMWs as in 318 with disposable filter use TOP9; for Rover K series use TOP2N; for Nissan SR20 use TOP19; for Rover, Buick, Oldsmobile, V8 use PC1. Where space is limited we can supply a replacement oil pump cover with outlets for a remote filter plus oil cooler if required. NEW TOP2N: M22 thread and reduced weight.

TOP9



PC1



TOP2N **NEW TO CATALOGUE!**

TOP19 **NEW TO CATALOGUE!**



TOP20 **NEW TO CATALOGUE!**



TOP25 **NEW TO CATALOGUE!**



**Type J** On vehicles with spin on filters where there is insufficient room to fit a sandwich plate and cartridge, even with the shortest cartridge, use a take off plate with connections to a remote filter in place of existing filter. Top take off, will require a minimum of 4.5" clearance including hose fittings and adapters.

Top Take off TOP1 & B/C/D/F/G



TOP1-B



TOP8 for BMC A series, made from billet spin on filter, made from billet. (not illustrated).

TOP16 & TOP16A for Chevrolets, have top ports (not illustrated).

TOP27 - used for Fiat 500 and Punto Abarth Models

**Type K** On vehicles where there is insufficient room to fit a sandwich plate and cartridge even with the shortest cartridge and where Type J is not suitable, use a sandwich plate with a top cover. Can be turned to face any direction.

TOP16E Chevrolet



Side Take off TOP01 & C/D/F



TOP06 for Triumphs, TOP26 for BMWs, sideport (not illustrated)

**Type M** Plate that converts existing filter to a spin on; then use an SP1/OTSP1 for oil cooler connection.

OTSP1 with FC8741



**Type N** Converts existing connections to a more common thread allowing fitment of an alternative or large oil filter.

OCT017-10



OCT017-12



Oil cooler take off kit for BMW

Designed for the BMW E36/E46/E90 to enable you to replace the standard oil cooler "hard lines" which can cause fitment issues for cars with superchargers, Accusumps or aftermarket oil coolers. Supplied in either -10JIC or -12JIC fittings with mounting bracket, O-rings, bolt and washer enabling the use of -10 or -12 flexible piping.

**Type P** Enables replacement of an OEM filter housing cap with a billet aluminium one, allowing sensors to be fitted; with oil cooler take off ports M22x1.5.

OCTBMW1



OCTBMW2



OCTBMW1 is suitable for use engine codes M52 and M54 Engines

OCTBMW2 is suitable for use on engine codes M50, S50, S52 and S54.

## Fitting Chart

Make	Model	Sandwich type	A-E	Take off type	F-P
Alfa Romeo	All 4 cylinder models	SP14	B		
	All 4 cylinder models after 1972	SP1	A	TOP1/01	JK
Audi	Most models	SP1	A	TOP1/01	JK
	Sprite	M/M	C		
Austin Healey	All 6 cylinder models	SP15	A		
BMC	All models with spin on filter	M/M	C		
BMW	All models with spin on filter	SP1	A	TOP1/01	JK
	New Mini Cooper S early supercharged			TOP3	F
	New Mini 2nd generation with R56 eng			TOP17	F
	318 models 2000-2004			TOP9	I
	M3, E46, 335i, E90/92/93			OCT017-10/12	
	M52 and M54			OCTBMW1	P
	M50,S50, S52 and S54			OCTBMW2	P
Buick	All models 1959 to 1977	SP1C	A	TOP1C/01C	JK
	All models 1978 on	SP1D	A	TOP1C/01D	JK
Cadillac	V6 all models 1960 on	SP1C	A	TOP1X/01C	JK
	With GM LS engine			OTGM	H
Chevrolet	All V8 models with spin on filter	SP16	A	TOP16C TOP16E	J K
	All models 1978 on except LS engines	SP1D	A	TOP1D/01D	JK
	Camaro, Corvette with LS engine			OTGM	H
Chrysler US	All models 1959 on	SP1	A	TOP1/01	JK
Chrysler GB	All models	SP1	A	TOP1/01	JK
Citroen	Saxo	SP1F	A	TOP1F/01F	JK
Datsun/Nissan	All models*	SP1*	A	TOP1/01	JK
Fiat	All models	SP1	A	TOP1/01	JK
	500 and Punto Arbarth			TOP29	F
Ford GB	Anglia 105E, Cortina & Escort 1970 on	SP1	A	TOP1/01	JK
	Above but pre October 1970	SP3	A		
	V4 and V6 models	SP1	A	TOP1/01	JK
	Focus ST/RS MK2 2.5 2005-10			TOP24	F
	Mustang Coyote			TOP20	F
Ford USA	All models 1959 on	SP1	A	TOP1/01	JK
Holden	With GM LS engine			OTGM	H
Honda	Accord, CRX, Prelude	SP1F	A		
Jaguar	MK2, 240, 340, XK150	SP10	A		
	All 6 cylinder models with spin on			TOP10	J
Lotus	All models pre 1971	SP3	A		
	Eclat, Elan to 75, Esprit, Europa, Excel	SP1	A	TOP1/01	JK
	Elan 1989-1995	SP1F	A	TOP1F/01F	JK
	Exige, Elise	SP1C	A	TOP1C/01C	JK
	Europa s 2006 on	SP1D	A	TOP1D/01D	JK
MG	Late TD/TF	SP24	A		
	Midget 1500	SP1A	A	TOP1A/01A	JK
	MGA, MGB	M/M	C		
	MGF, TF 2002 on, R, S, Z, T with spin on	SP1C	A	TOP1C/01C	JK
	MG RV8	SP1	A	TOP1/01	JK
Mazda	All models	SP1F*	A	TOP1F/01F	JK
Mitsubishi	All models	SP1F*	A	TOP1F/01F	JK
Morgan	Plus 4 with Triumph engine	SP9	B		
	Plus 4 with Triumph engine	SP13	A		
	See explanation under Triumph				
	Plus 4 with Ford or Fiat engine	SP1	A	TOP1/01	JK
	Plus 4 with Rover 2 litre engine	SP1C	A	TOP1C/01C	JK
	4x4, Roadster, Plus 8 but not BMW	SP1	A	TOP1/01	JK
Nissan	Sylvia SR20			TOP19	I
Peugeot	204/5 & 304/5 up to 1975 except Diesel	SP1D	A	TOP1D/01D	JK
	204/5 & 304/5 1975 on	SP1F	A	TOP1F/01F	JK
Pontiac	All models 1968 to 1978	SP1C	A	TOP1C/01C	JK
	All models 1978 on except LS engines	SP1D	A	TOP1D/01D	JK
	Firebirds with LS engines			OTGM	H
Porcshe	986/996/997/987			TOP26	F
Reliant	V6 models	SP1	A	TOP1/01	JK
Renault	All models up to June 1984	SP1	A	TOP1/01	JK
	Most models after June 1984	SP1F	A	TOP1F/01F	JK
	GTE turbo with donut oil cooler	SP1J	A	TOP1J/01J	JK
	2000, 3500 & all modes with SD1 engine	SP1	A	TOP1/01	JK
	3500 with pre SD1 engine	SP1C	A	TOP1C/01C	JK
	The PC1 is a replacement pump cover with oil outlets, can be fitted to all V8 Rover engines and used with a remote filter			PC1	I
	Land Rover 4 cylinder	SP11	B		
	214, 220, 414i, 420 K series, 820	SP1C	A	TOP1C	JK
	216 to 1990	SP1	A	TOP1/01	JK
	216 1990 on Honda engine, 218, 416, 418, 600	SP1F	A	TOP1F/01F	JK
	All K series engines	SP1CA		TOP2N	I
Saab	All models with spin on filter	SP1	A	TOP1/01	JK
Seat	Most models but ask if fitted with heat exchanger, might need extra extension bolt	SP1	A	TOP1/01	JK
Smart	All models but use FC8741 to convert to spin on filter	SP1	A	TOP1/01	M
Subaru	All other models, Impreza, Forester etc.*	SP1F	A	TOP1F/01F	JK
	Except for BRZ use SP with SPA1 spacer	SP1F-25			
Toyota	All models*	SP1	A	TOP1/01	JK
	Except for GT86 use SP with SPA1 spacer	SP1F-25			
Triumph	Spitfire, Herald	SP1A	A	TOP1A/01A	JK
	TR5, TR6, r.h.d. GT6 and Vitesse	SP6	A	TOP06	J
	TR2/3/4/4a	SP9	B		
	TR2/3/4/4a	SP13			
	With SP9 the oil cooler is upstream of the oil pressure valve, damage has occurred during high RPM cold starts. The SP13 avoids this problem but does not suit all applications.				
	2000, 2.5Pi, left hand drive GT6	FH3	D		
	TR7, Dolomite			TOP7	H
	Stag			TOP7B	H
Vauxhall	Early 4 cylinder engines pre spin on filter	SP4	D		
	Most engines with spin on filter pre 1981	SP1	A	TOP1/01	JK
	Most engines with spin on filter post 1981	SP1D	A	TOP1D/01D	JK
	Models with GM LS engine			OTGM	H
Volkswagen	Beetles without oil filter			TOP27	G
	Most models inc. Beetle with oil filter but might need special extension bolt if fitted with heat exchanger	SP1	A	TOP1/01	JK
Volvo	All models with spin on filter	SP1	A	TOP1/01	JK

\* Japanese cars - problems may occur using original equipment filters with a raised lip. Fit appropriate SP100 or use aftermarket filters.

Take off plates are sold with screw(s), bolts, sealing ring(s) and gasket. For M18 ports add suffix M18, for M22 ports add suffix M22.

### Take Off Plates

Part No	
FH3	Tapped 1/2BSP
SP1	For Spin-On 3/4UNF Filter - Tapped 1/2BSP
SP1A	For Spin-On 5/8UNF Male Filter - Tapped 1/2BSP
SP1B	For Spin-On M16 Filter - Tapped 1/2BSP
SP1C	For Spin-On 13/16UNF Filter - Tapped 1/2BSP
SP1D	For Spin-On M18 Filter - Tapped 1/2BSP
SP1E	For Spin-On 5/8UNF Filter - Tapped 1/2BSP
SP1F	For Spin-On M20 Filter - Tapped 1/2BSP
SP1F-25	An SP1F With SPA1 25mm Spacer
SP1G	For Spin-On M22 Filter - Tapped 1/2BSP
SP100	M22 ports and 2 x 1/8NPT - From Billet
SP100F	As SP100 For M22 Tapped 1/2BSP - From Billet
SP100G	As SP100 For M22 Tapped 1/2BSP - From Billet
SP3	For Pre 1970 Ford - Tapped 3/8BSP
SP4	Early 4 Cyl Vauxhall Pre Spin-On Tapped 5/8UNF
SP5	Honda 4 Cyl Bike - Tapped 3/8BSP
SP6	Triumph 6 Cylinder Engines Tapped 3/8BSP
SP7	Late Mg TD/TF - Tapped 3/8BSP
SP9	Triumph TR2/3/4/4a - Tapped 3/8BSP
SP10	Jaguar MK2, 240, 340, XK150 - Tapped 3/8BSP
SP11	Land Rover 4 Cylinder - Tapped 3/8BSP
SP12	Tapped 5/8UNF
SP13	Triumph TR2/3/4/4A - Tapped 3/8BSP
SP14	Alfa Romeo 4 Cyl Pre 1972 - Tapped 3/8BSP
SP15	Austin Healey 6 Cylinder - Tapped 1/2BSP
SP16	Chevy V8 With Spin On Filter - Tapped M22
SP16N	Nissan TD35 1"UNF - Tapped 1/2BSP
SP24	MG Late TD/TF - Tapped 3/8 BSP
SP31	Jaguar 6 Cyl Billet Pre Filter Head - Tapped 1/2BSP
TOP3	BMW Mini Early Supercharged - Tapped M22x1.5
TOP17	BMW Mini 2nd Gen. R56 Engine - Tapped M22x1.5
TOP7	Triumph TR7/Dolomite Has 1/2BSP Male Adapters
TOPO1	For 3/4UNF Male Spiggot - Tapped 1/2BSP
TOPO1C	For 13/16UNF Male Spiggot - Tapped 1/2BSP
TOPO1D	For M18x1.5 Male Spiggot - Tapped 1/2BSP
TOPO1F	For M20x1.5 Male Spiggot - Tapped 1/2BSP
TOP1	For 3/4UNF Male Spiggot - Tapped 1/2BSP
TOP1A	For 5/8UNF Female Filter Port - Tapped 1/2BSP
TOP1B	For M16 Male Spiggot - Tapped 1/2BSP
TOP1C	For 13/16UNF Male Spiggot - Tapped 1/2BSP
TOP1D	For 18mm Male Spiggot - Tapped 1/2BSP
TOP1F	For 20mm Male Spiggot - Tapped 1/2BSP
TOP1G	For 22mm Male Spiggot - Tapped 1/2BSP
TOPO6	For Triumph 6 Cyl - Tapped 1/2BSP
TOP8	For BMC A Series Tapped Single 1/2BSP Port
TOP9	For BMW 4 Cyl 318 - Tapped M22x1.5
TOP2N	For Rover K Series- M22 Thread
TOP10	Spin On Type For Jaguar 6 Cyl - 1/2BSP Top Ports
TOP16A	Bolt On Type For Chevrolet V8 - 1/2NPTF top Ports
TOP27	VW Beetle - Replaces Cooler - Tapped 3/8NPTF
500	VW Beetle - Valve
PC1	Rover V8 Oil Pump Cover 1/2BSP Top Ports
TOP16E	Side Take Off Big Diameter - Chevrolet V8
TOP19	Take off plate Nissan SR20DET
TOP20	Ford coyote 5.0
TOP21	coyote 5.0 RHD
TOP24	Ford focus ST mk2
TOP25	Ford Duratec/ ecoboost
TOP26	Porcshe 986/996/997/987
TOP29	Fiat 500 and Punto Abarth 1.4 t-jet
OCTBMW1	BMW Cooler Take Off Eng M54
OCTBMW2	BMW Cooler Take Off E30/E46 M3
OCTO17-10	Oil Cooler Take Off Kit For BMW In -10JIC
OCTO17-12	Oil Cooler Take Off Kit For BMW In -12JIC
<b>Take Off Plates With Built In Thermostat</b>	
OTSP1	As SP1 But With Built In Oilstat
OTSP1HF	As OTSP1 But High Flow Version Tapped M22x1.5
OTSP1C	As SP1C But With Built In Oilstat
OTSP1CHF	As OTSP1C But High Flow Version Tapped M22x1.5
OTSP1D	As SP1D With Built In Oilstat
OTSP1DHF	As OTSP1D But High Flow Version Tapped M22x1.5
OTSP1F	As SP1F With Built In Oilstat
OTSP1F-25	OTSP1F With SPA1 25mm Spacer
OTSP1FHF	As OTSP1F But High Flow Version Tapped M22x1.5
OTSP1G	As SP1G With Built In Oilstat
OTSP1GHF	As OTSP1G But High Flow Version Tapped M22x1.5
OTSP16	As SP16 With Built In Oilstat
TOP24T	Ford Focus ST mk2 with built in Oilstat

## Temperature Gauge Adapters

A range of adapters to take all types of capillary gauge, they are designed to be fitted into oil or water hoses. Oil hose adapters are 2 part aluminium die castings with an O ring seal. Hose connections are male push on, JIC, BSP or female NPTF. Water hose adapters are machined from billet.



Prefix	Tapping	Makes of gauge
TGA4	3/8 BSP	MOCAL, Racetech, Smiths competition
TGA2	5/8 UNF	Caerbont, other UK, USA, Japan
TGA3	M14 x 1.5	European
TGA5	1/4 BSPT	DC water pumps and fans

Part No	
TGASP	As SP1 With 5/8UNF Tapping For Temp Gauge
TGASP1	As SP1 With 3/8BSP Tapping For Temp Gauge
TGASP1/8NPTF	As SP1 With 1/8NPTF Tapping For Temp Gauge
TGASPM14	As SP1 With With M14 Tapping For Temp Gauge
TGASPM16	As SP1 But With M16 Tapping For Temp Gauge
TGASPM18	As SP1 But With M18 Tapping For Temp Gauge
TGA21	5/8UNF X 3/8in Push On
TGA2A	5/8UNF X 1/2in Push On
TGA2B	5/8UNF X 5/8in Push On
TGA2C	5/8UNF X 1/2BSP Male
TGA2D	5/8UNF X 1/2BSP Female
TGA2E	5/8UNF X 1/2NPTF Female
TGA2F	5/8UNF X 5/8BSP Male
TGA2G	5/8UNF X 3/4BSP Male
TGA2H	5/8UNF X -8JIC Male
TGA2I	5/8UNF X -10JIC Male
TGA2J	5/8UNF X -12JIC Male
TGA2K	5/8UNF X -16JIC Male
TGA2L	5/8UNF X 3/4in Push On
TGA2M	5/8UNF X 32mm Push On (Billet)
TGA2N	5/8UNF X 35mm Push On (Billet)
TGA2O	5/8UNF X 38mm Push On (Billet)
TGA2-85	5/8UNF X M18 Female
TGA31	M14x1.5 X 3/8in Push On
TGA3A	M14x1.5 X 1/2in Push On
TGA3B	M14x1.5 X 5/8in Push On
TGA3C	M14x1.5 X 1/2BSP Male
TGA3D	M14x1.5 X 1/2BSP Female
TGA3E	M14x1.5 X 1/2NPTF Female
TGA3F	M14x1.5 X 5/8BSP Male
TGA3G	M14x1.5 X 3/4BSP Male
TGA3H	M14x1.5 X -8JIC Male
TGA3I	M14x1.5 X -10JIC Male
TGA3J	M14x1.5 X -12JIC Male
TGA3K	M14x1.5 X -16JIC Male
TGA3M	M14x1.5 X 32mm Push On (Billet)
TGA3N	M14x1.5 X 35mm Push On (Billet)
TGA3O	M14x1.5 X 38mm Push On (Billet)
TGA3-65	M16x1.5 X 3/8in Push On
TGA41	3/8BSP X 3/8in Push On
TGA4A	3/8BSP X 1/2in Push On
TGA4B	3/8BSP X 5/8in Push On
TGA4C	3/8BSP X 1/2BSP Male
TGA4D	3/8BSP X 1/2BSP Female
TGA4E	3/8BSP X 1/2NPTF Female
TGA4F	3/8BSP X 5/8BSP Male
TGA4G	3/8BSP X 3/4BSP Male
TGA4H	3/8BSP X -8JIC Male
TGA4I	3/8BSP X -10JIC Male
TGA4J	3/8BSP X -12JIC Male
TGA4K	3/8BSP X -16JIC Male
TGA4M	3/8BSP X 32mm Push On (Billet)
TGA4N	3/8BSP X 35mm Push On (Billet)
TGA4O	3/8BSP X 38mm Push On (Billet)
TGA4-105	3/8BSP X M22 Female
TGA5	1/4BSPT X M30 To M42 Push On

## Remote Filter Heads

Function: To relocate the oil filter, when required due to lack of room, brought about by engine changes, installation in kit cars, fitting an oil cooler or in a dry sump system. They are usually used in conjunction with a take off plate which is screwed on in place of the original filter.

Construction: Die cast aluminium or billet

Application: Flows listed are for filters as illustrated (note that oil always flows into the outside of the filter and exits up the middle). Filter heads can be mounted in any attitude, but we suggest when choosing an oil filter that is to be fitted in other than an upright, filter below, position, it should have an anti-drain valve. No provision is made in the head for filter relief valves, these are available in the filter and used if regular changing cannot be relied upon and/or if the engine is likely to be revved from cold. We will stock a huge range of bespoke WIX filters and will be pleased to advise on suitable fitments.

RFH1



RFH1 takes filter with 3/4UNF thread. A compact design which will require a spacer if a filter larger than 80mm diameter is mounted against a flat surface. Provision can be made to take a capillary type temperature gauge sender or pressure gauge tapping. Available in either flow direction. Has 1/2BSP female ports.

RFH2E takes filter with 3/4UNF thread, has 1/2BSP ports. RFH2G takes 1"UNF and has 3/4BSP ports. Both 80 & 98mm diameter filters can be accommodated. Bosses are provided which may be tapped to provide for pressure gauge, oil feed take offs, etc. Left to right flow only.

RFH3



RFH3 takes filter with 3/4UNF thread. Left entry RFH3A (pictured above) has 1/2BSP ports, Right entry RFH3B has 1/2NPTF ports. 80 & 98mm diameter filters can be accommodated. RFH3A has bosses that may be tapped for pressure/temperature take offs.

RFH4 takes filter with 3/4 UNF thread, has top entry 1/2 NPTF ports.

RFH5



RFH5 takes 2 filters in parallel with 3/4UNF thread, feed and return from either side, 1/2NPTF, ports blanking plugs included.

RFH6 takes filter with 3/4UNF thread, feed and return from either side, 1/2NPTF ports, blanking plugs included.

RFH2



RFH4



RFH3AB **NEW TO CATALOGUE!**

RFH3BB



RFH3AB is a billet alternative for RFH3BA with left hand entry and M22x1.5 female ports.

RFH3BB is a billet alternative for RFH3B with right hand entry and M22x1.5 female ports.

RFH7

RFH2GB **NEW TO CATALOGUE!**



RFH7 takes unique Chevrolet filter, big and small block V8s to 1978. 13/16UNF thread and 4" diameter. Feed and return from either side, tapped 1/2NPTF ports, blanking plugs included. Spare port can be temperature or pressure take off

### Part No

RFH1G	Flows L To R With 3/8BSP Temp Take Off
RFH1H	Flows R To L With 3/8BSP Temp Take Off
RFH1A	Flows L To R With 5/8UNF Temp Take Off
RFH1B	Flows R To L With 5/8UNF Temp Take Off
RFH1C	Flows L To R With M14 Temp Take Off
RFH1D	Flows R To L With M14 Temp Take Off
RFH1E	Flows L To R With No Temp Take Off
RFH1F	Flows R To L With No Temp Take Off
RFH2E	Flows L To R No Take Off 3/4UNF With 1/2BSP Ports
RFH2EB	Flows L To R No Take Off 3/4UNF With M18 Ports
RFH2G	Flows L To R No Take Off 1"UNF With 3/4BSP Ports
RFH2GB	Flows L to R No Take Off 1"UNF x 3/4BSP (Black)
RFH2GB-M22	Flows L to R No Take Off 1"UNF x M22 (Silver)
RFH2GB-M22BK	Flows L to R No Take Off 1" UNF x M22 (Black)
RFH3A	Flows Left Hand In/Out No Take Off
RFH3AB	Flows Left Hand In/Out Billet M22 ports
RFH3BB	Flows Right Hand In/Out Billet M22 Ports
RFH3B	Flows Right Hand In/Out No Take Off
RFH4	Flows Top In/Out No Temp Take Off
RFH5	Double Filter - Flows Either Way
RFH6	Single Filter - Flows Either Way
RFH6B	Single Filter - Flows Either Way Billet
RFH7	Flows Either Way 13/16UNF With 1/2 NPTF Ports
MFS9-3-7	Oil Pressure Take Off For RFH1A/B

## Complete Remote Oil Filter Kits

### Part No

RFK1	Land Rover With Pre SDI V8 - Side Take Off
RFK2	Land Rover With SDI V8 -Side Take Off
RFK3	Land Rover With Pre SDI V8 -Top Take Off
RFK4	Land Rover With SDI V8 -Top Take Off
RFK5	Land Rover With V8 PC1-Pump Cover

## XRP In-Line Engine Oil Filters



Function: These kits comprising take off or pump cover, remote filter head, adapters and hoses are available for the popular Land Rover/V8 conversion.



A modular range of in-line oil filter assemblies consisting of a choice of: Filter body in two sizes, order with spring. Part No 704302.



Filter elements in 4 degrees of filtration, can also be supplied with pressure relief valve to ensure flow if filter blockage occurs.



End caps plus O rings with SAE 37°/JIC/AN or metric connections can also be supplied with extra 7/8UNF tapping and 5/8UNF adapter to take most temperature gauges.



Joiners plus O rings to connect filter bodies in series.



Small in-line 120 micron fuel filter



Mounting brackets to tube or sheet metal.

In line filters made from billet aluminium with black anodising, the filter elements are made up of a plain Dutch weave filter cloth from 304 stainless steel.

The plain Dutch weave provides high flow rates with good filtration properties. As it is mainly surface filtration these filters may be cleaned by back flowing with a suitable solvent or using ultrasound methods, however it may not be possible to remove deeply embedded particles. Testing with flows up to 100litres/min have shown no measurable pressure drops with filters in their uncontaminated state.

These filters are designed for racing applications where regular inspection between races will take place but for total security a pressure relief valve may be incorporated in the filter, alternatively end caps and joiners with ports for a pressure differential gauge and/or warning light are available.

Two bodies may be screwed together to extend the filter life between cleaning or replacement. A coarse filter initially then a finer filter will prove effective.

Part No	Size	Diameter (inches)	Length (inches)
704-406FS120	-6JIC X	1.115	4.6
704-408FS120	-8JIC X	1.115	4.8
7041406FS120	-6JIC X M14x1.5	1.115	4.4
7041408FS120	-8JIC X M14x1.5	1.115	4.6
704808FS120	-8JIC X M18x1.5	1.115	4.6
704110	-10JIC	1.115	5.0
704112	-12JIC	1.115	5.2

Part No	Description
713000	71 Series Body 2.47 Dia.
713000S	71 Series Short Body 2.47 Dia.
704302	In-Line Body Spring
713045	45 Micron Element
713060	60 Micron Element
713075	75 Micron Element
713100	100 Micron Element
713045S	Short 45 Micron Element
713060S	Short 60 Micron Element
713075S	Short 75 Micron Element
713100S	Short 100 Micron Element
713045RV	45 Micron Element With Relief Valve
713060RV	60 Micron Element With Relief Valve
713075RV	75 Micron Element With Relief Valve
713100RV	100 Micron Element With Relief Valve
713045SRV	Short 45 Micron Element With Relief Valve
713060SRV	Short 60 Micron Element With Relief Valve
713075SRV	Short 75 Micron Element With Relief Valve
713100SRV	Short 100 Micron Element With Relief Valve
713108AN	08 AN End Cap - In
713106AN	06 AN End Cap - In
713110AN	10 AN End Cap - In
713112AN	12 AN End Cap - In
713206AN	06 AN End Cap - Out
713208AN	08 AN End Cap - Out
713210AN	10 AN End Cap - Out
713212AN	12 AN End Cap - Out
713206ANPD	06 AN End Cap - Out With Differential Press Take-Offs
713208ANPD	08 AN End Cap - Out With Differential Press Take-Offs
713210ANPD	10 AN End Cap - Out With Differential Press Take-Offs
713212ANPD	12 AN End Cap - Out With Differential Press Take-Offs
713210ANAP	10 AN End Cap - In With Accessory Port
713212ANAP	12 AN End Cap - In With Accessory Port
981410TP	5/8UNF Temperature Probe Adapter
717002	Filter Stacking Adapter
717003	Filter Stacking Adapter With Differential Press Take-Offs
704-406FS120	-6JIC Fuel Filter 120µ
704-408FS120	-8JIC Fuel Filter 120µ
7041406FS120	-6JIC X M14 Fuel Filter 120µ
7041408FS120	-8JIC X M14 Fuel Filter 120µ
7041808FS120	-8JIC X M18 Fuel Filter 120µ
704110	-10JIC Dry Sump
704112	-12JIC Dry Sump



## Early Warning Systems

### Pressure switches



Low pressure switches make on the fall i.e. Activate a suitable warning when pressure falls below a chosen point. They are adjustable within a range of 15-120 (1-8bar) These have a 1/8NPTF thread so screw into a:

- Matching thread on T piece
- Hose end Tee (page 43)
- Fuel/oil pressure adapter (page 61)
- Filter head may be tapped to take switches (page 23)

Part No	
EWS/2B	Low Pressure Switch- Adjustable 1.45 To 14.5psi
EWS/1C	Low Pressure Switch Adjustable Set @ 20psi
EWS/1D	Low Pressure Switch adjustable Set @ 35psi
BLS8-3	1/8NPTF Brake Light Switch
BLS2-31	M10 X 1 Brake Light Switch

## Sandwich Plates Between Engine & Filter



Where there is no suitable block tapping, we have a thin sandwich with 2 x 1/8 NPTF & 1 x 3/8BSP tappings. Made from billet aluminium, supplied with 3 Plugs and extension screw. This will fit cars with a spin on filter, see fitting chart on page 20, SP1 range.

Part No	
TGASP200	With 3/4UNF Extension Screw As SP1
TGASP200D	With M18 Extension Screw As SP1D
TGASP200F	With M20 Extension Screw As SP1F

## T Pieces & Oil Pressure Gauge Adapters



T pieces have one male thread to screw into the oil gallery, a female thread to take the original transmitter and a female 1/8 NPTF tapping which allows a pressure switch or a 1/8 BSP female pressure gauge line to be attached via a MMS10-3-3 adapter (page 56). The chart below covers most engines.

Make	Thread	Part No	Make	Thread	Part No
Alfa Romeo/Alfasud	M14 x 1.5	TP7	Mitsubishi	1/8BSPT	TP8
Alfa Romeo remainder	M10 x 1.0	TP15	Nissan	1/8BSPT	TP8
Austin/ Morris	1/8NPTF	TP1	Opel up to 1973	M14 x 1.5	TP7
BMW up to 1969	M10 x 1.0	TP15	Opel from 1973 on	1/4NPTF	TP2
BMW from 1969 on	M12 x 1.5	TP6	Peugeot	M14 x 1.5	TP7
Chevrolet	1/8NPTF	TP1	Porsche	M10 x 1.0	TP15
Chrysler/ Talbot	1/8NPTF	TP1	Renault	M14 x 1.5	TP7
Citroen CX	M14 x 1.5	TP7	Rover K series - varies	M12 x 1.5	TP6
Citroen remainder	M12 x 1.5	TP6	Rover K series - check	1/8NPTF	TP1
Fiat	M12 x 1.5	TP6	Rover V8	1/2UNF	TP3
Ford up to 1971	1/8NPTF	TP1	Saab	1/8NPTF	TP1
Ford from 1971 on	1/4NPTF	TP2	Skoda	M10 x 1.0	TP15
Hillman	1/8NPTF	TP1	Subaru	1/8BSPT	TP8
Holden	1/4NPTF	TP2	Toyota	1/8BSPT	TP8
Honda	1/8BSPT	TP8	Triumph	1/8NPTF	TP1
Jaguar/ Daimler	1/8NPTF	TP1	Vauxhall up to 1979	1/4NPTF	TP2
Lada	M14 x 1.5	TP7	Vauxhall 1980	M14 x 1.5	TP7
Lancia	M14 x 1.5	TP7	Volkswagen	M10 x 1.0	TPVW
Mazda	1/8BSPT	TP8	Volvo	1/8NPTF	TP1

Part No	
TP1	T Piece 1/8NPTF
TP2	T Piece 1/4NPTF
TP9	T Piece M10x1.5
TPVW	T Piece M10x1
TP6	T Piece M12x1.5
TP7	T Piece M14x1.5
TP12	T Piece M16x1.5
TP8	T Piece 1/8BSPT
TP3	T Piece 1/2UNF
TP4	T Piece 1/4BSP
TP5	T Piece 3/8BSF

### Pressure Gauge Adapters To Suit TP's

Part No	
MMS10-3-3	Pressure Gauge Adapter 1/8BSP X 1/8NPTF
MMS10-3-4	Pressure Gauge Adapter 1/8BSP X 1/4NPTF
MMS5-3-31	Pressure Gauge Adapter 1/8BSP X M10x1
MMS5-3-41	Pressure Gauge Adapter 1/8BSP X M12x1.0
MMS5-3-45X	Pressure Gauge Adapter 1/8BSP X M12x1.5
MMS6-3-3	Pressure Gauge Adapter 1/8BSP X 1/8BSPT
MMS3-3-4	Pressure Gauge Adapter 1/8BSP X 1/4BSP
MMS3-3-6	Pressure Gauge Adapter 1/8BSP X 3/8BSP
MMS11-3	Pressure Gauge Adapter 1/8BSP X 3/8BSF
MMS9-3-5V	Pressure Gauge Adapter 1/8BSP X 1/2UNF

## Warning Lights



These are of little use if they are not immediately visible, ours are 29mm diameter with a choice of red, yellow, green, blue or clear lens. These have a removable diffuser under the lens which may be titled using dry print lettering.

Available colours ■ ■ ■ ■ ■

Part No	
EWL-AMBER	Warning Light 30mm Amber Lens
EWL-BLUE	Warning Light 30mm Blue Lens
EWL-GREEN	Warning Light 30mm Green Lens
EWL-RED	Warning Light 30mm Red Lens
EWL-CLEAR	Warning Light 30mm Clear Lens
EWL/BULB	Warning Light Bulb

## MOCAL Temperature Strips

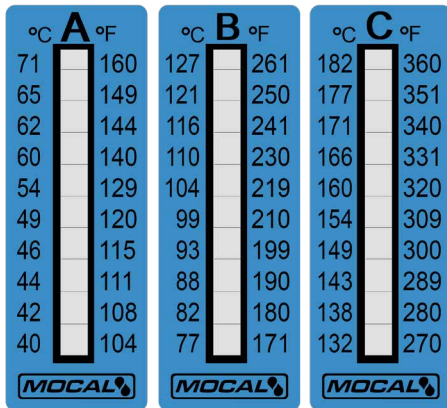

Available in three temperature ranges to cover all fluid measurement requirements. Self adhesive strips, sold individually.

Part No	
TS1	Temperature Strip 77°C To 127°C ( B )
TS2	Temperature Strip 40°C To 71°C ( A )
TS3	Temperature Strip 132°C To 182°C ( C )

## Conversions To Spin Off Type Filters

Aluminium adapter plates and threaded centre screws to convert cars with removable element filters to spin off cartridge filters. In most cases, to compensate for the variations in Filter Head tolerances, the Filter Conversion consists of three parts; Spin On Inner, Spin On Outer and an O ring. The variations in tolerances are taken up by Spin On Outer sliding over the Spin On Inner. The integrity of the seal between the Inner and the Outer is maintained by the O ring. We will stock a huge range of bespoke WIX filters and will be pleased to advise in suitable fitments.

FC283 for BMC A series

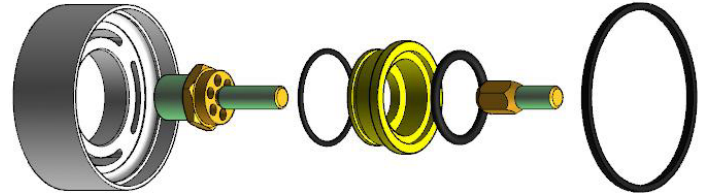

FC290 for Triumph 6 cylinder

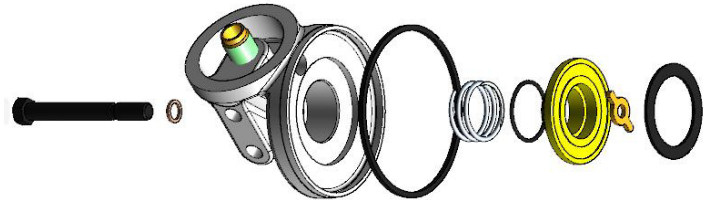

## Spin On Adaptors From Threaded Billet

A current trend has seen manufacturers return to replacement element type filters. For some of these such as the Smart Car we have made a threaded billet adaptor with seals and extension bolt to convert to spin on element.

FC8741 for Smart Car series

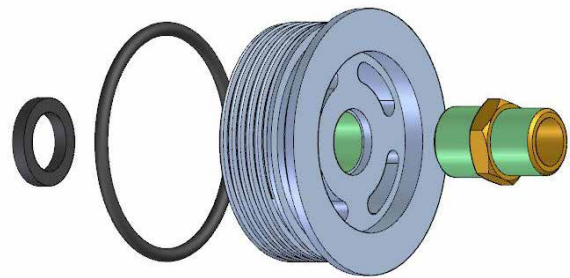

Part No	
FCDB2	Aston Martin DB2
FC283	BMC A Series-Austin Healey Sprite - MG Midget
FC1767	Austin Healey 6 Cylinder Models
FC289	MG A & B
FCMGC	MG C
FC285	Triumph TR2/3/4/4a With Puralator Filter Head
FC1766	Triumph TR2/3/4/4a With Tecalimet Filter Head
FC290	Triumph 6 Cyl Models
FC292	Triumph TR7
FC286	Jaguar E Type 3.8
FC287	Jaguar Mark 1 & 2 - 2.4 Engine To BH7968-3.4 To KH7062- 3.8 To LC4264
FC288	Jaguar Mark 2 Remainder- E Type 4.2 To 7R2297 &
FC291	Jaguar XJ6
FC3191	Chevrolet Corvair
FC1369	York Diesel
FC8741	Mercedes Smart
FC295	Land Rover Series 1

## Hose & Fittings, An Overview

### Different Types Of Hose

A bewildering number of hoses is on offer for vehicle plumbing this choice can be dictated by price, performance, weight, appearance and sporting regulations. However all leading hose suppliers offer a range that is similar and in most cases interchangeable.

### FIA Regulations

These regulations apply to vehicles taking part in FIA controlled races. Their Appendix J Article 253, pertaining to lines and pumps has been curiously drafted and contains the following: "When flexible, these lines must have threaded, crimped or self sealing connectors and an outer braid resistant to abrasion and flame (will not sustain combustion)". All Aeroquip and Pro Gold hoses that we feature satisfy this requirement although the push on hoses would need an Oetiker hose clamp, see page 51. The regulations then demand 1000 psi burst pressure at 235°C for oil lines. We know of only one hose that will meet this requirement and this is a TFE hose which due to its rigidity (large bend radius) is quite unsuitable for general plumbing. We have alerted the FIA to the problem but in the meantime it is pretty certain that 99.99% of cars are racing illegally.

### Fuel Hoses

Until recently all hoses offered for oil were suitable for pump fuel, however two things have happened that have altered the situation. Firstly fuel injection has introduced the phenomenon of sour fuel in return lines where aeration introduces peroxides into the fuel, secondly the removal of lead from fuels has brought about the use of additives to improve the octane rating both these moves produce a more aggressive mixture that can cause swelling and permeation (fuel smells) in all synthetic rubber hoses. Only TFE or hoses to specification SAE 30/R9 are completely suitable for fuel injection returns and more exotic fuels.

### The Cheapest Hoses

Textile hoses with synthetic rubber inner tube, one layer of textile braid reinforcement and a synthetic rubber outer layer are available in two types, the SAE 100 R6 **MOCAL** hose is suited to most applications with a maximum suggested temperature rating of 120°C and a working pressure of 400psi, use with factory swaged on fittings or worm drive / Oetiker clamps.

#### Push in hose and fitting

Another variation of this type of hose is the push on, as in Aeroquip Socketless®. Pushfit, push-lite or push-lok are similar, the fitting

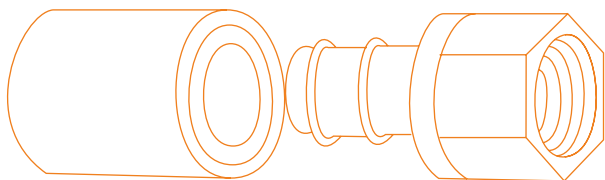

is simply pushed into the hose, this hose has the reinforcing braid woven in such a way that the grip on the fir tree type fitting increases as the force trying to push it out increases, this hose has had a resurgence of popularity recently, especially since aluminium fittings were introduced, this type of hose and fitting is interchangeable between makes but only genuine Aeroquip assemblies can be guaranteed. These hoses usually have a black rubber covering other colours are available, light blue being very popular. We can provide a stainless steel braid covering for these textile hoses this does not impart any greater strength only enhanced appearance and abrasion resistance, unless the hoses are factory swaged a finisher such as a Pro clamp® must be used to hide frayed ends.

### The Best Hoses

For war zones like Vietnam the US military required a range of strong, light high temperature hose assemblies that could be serviced in the field for use in oil, fuel and hydraulic applications, mainly on helicopters. Aeroquip came up with the AE701 hose and Little Gem® fittings, these eventually found their way onto the war surplus market and were seized upon by the motor racing fraternity. These hoses have an elastomer inner tube, partial stainless steel wire inner braid and a full stainless steel outer braid. The fittings are mainly aluminium anodised blue and red.

The supply of these hoses and fittings gradually dried up, and a new industry came into being making compatible hose and fittings. Earls Permo-o-flex, Goodridge 200 and XRP Kb-plus. Aeroquip returned to the market with the hose renamed FC333 Racing hose. All these hoses and fittings are interchangeable but only assemblies from one manufacturer have any guarantee. We refer to all these as aerospace style hose and fittings. Despite the interchangeability there are differences in design of the method of fitting and the means of achieving a double swivel on angled fittings. In the beginning the Aeroquip Little Gem fittings had a cutter style attachment which was suited to coping with the high pressures in hydraulic systems and assembly by trained personnel, for the less demanding motor sport use they opted for the far more user friendly compression style fitting, unlike the competition which stayed with the old design. Aeroquip were late in producing a double swivel angled fitting but when they did they overcame problems, associated with existing designs, where to achieve a swivel the fitting had to turn in the hose thus breaking the primary seal and often, when sticking occurred, the secondary seal as well. The accompanying drawing illustrates the situation.

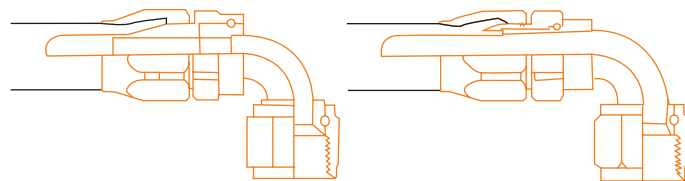

Compression Fitting

Cutter Fitting

### The Lightest Hose

With F1 manufacturers constantly looking for ways to save weight someone came across an extremely light hose assembly consisting of a convoluted wrapped PTFE (Teflon) liner with a Nomex covering used for conduits in aircraft wiring harnesses. These very expensive hose assemblies were soon adopted in the higher echelons of the sport. Interpretations of this type of hose vary among motor sport suppliers, the best supply a wrapped TFE liner, others an extruded liner with convolutions moulded in, the latter type of hose suffers from high volumetric expansion, especially linearly, if used in long lengths the hose tends to writhe around like a demented snake when subjected to varying pressures. PTFE hoses are resistant to all types of fuel. They are also available with stainless steel braid outer covering. Where the utmost weight saving is sought factory swaged fittings are used but hoses with reusable fittings still offer a significant weight saving. Recommended working pressures are around 200 psi/14 bar and max temperatures 150°C. We distribute the BMRS Pro Gold range. There is no interchangeability of hoses and fittings between different manufacturers.

Despite a deal of experience in manufacturing convoluted TFE, Aeroquip have entered the lightweight hose market with Startlite a patented AQP® (synthetic rubber) inner tube with Nomex covering and reinforcement, to achieve the greatest weight saving it is available with swaged on end fittings, it will also accept the red and blue reusable fittings normally used with the Aeroquip FC333 racing hose. The Kevlar cover has a thicker weave than that used on ProGold and amazingly, the hose feels cool to the touch with oil at 100°C flowing through.

## Special Purpose Hoses

Silicon Coolant / Charge air hoses were originally manufactured for maximum longevity, as in trucks and specialist very high temperature applications. It is become popular for the less demanding high performance car market due to its attractive colours, shiny finish and feel good factor. Should last and keep its appearance for the life of the vehicle. Can be made to suit any application.

Oil / Fuel hose to B.S. AU 108/2-L4/C4/R a hose designed for under bonnet use with push in but secured with worm drive clamps or similar fittings in smaller sizes i.e. Carburettor hoses, automatic transmission cooling. We can supply with stainless steel overbraid.

Fuel hose to SAEJ30 R9 a hose suitable for use in fuel injection systems has a thin flexible layer of fluoro-elastomer in the bore providing exceptional resistance to sour petrol plus methanol and ethanol additives, use with clamped push in fittings.

Fuel hose for small boats SPH5 to B.S. 3212/1991 for Lpg use in pleasure boats licensed by NRA. SPH10 fire resistant hose for petrol & diesel. Use with push on fittings and stainless steel worm drive clip.

Vacuum servo hose specially formulated for this purpose. Use with clamped push in fittings.

Brake fluid hose specially formulated for use with all types of brake fluid, mainly used for gravity feed from reservoir to master cylinder.

Fire resistant hoses are the ultimate fuel hose, top pressure and temperature ratings, will withstand 2 ½ minutes exposure to flame. Use with brass reusable fittings. Designed for boat use.

## Brake & Clutch Hoses

Conventional brake hoses, manufactured in rubber with textile reinforcement, are permitted to have a significant amount of volumetric expansion, that is they swell under pressure, this leads to a soft feel to the brake pedal, acceptable in a road vehicle but not in competition usage.

This has led to the universal usage of smooth bore PTFE (Teflon®) hose with normally a stainless steel or rarely a Kevlar® braided outer cover. This hose has the added benefit of lightness, strength, high temperature resistance and protection from stone damage We call it **MOCAL** TFE , Aeroquip TFE racing hose or 2807, Aeroquip Aerospace 666 , other brand names are Speed-Flex , 600 , and 411 . They can be had with reusable or swaged on fittings. With the exception of Aeroquip Aerospace, hose and fittings are interchangeable between brands.

Some countries, not the UK, insist on tests for brake hoses the TFE hose assembly passes all the tests except the whiplash test which ensures that the hose is suitable for withstanding large wheel movements on vehicles doing hundreds of thousands of miles, quite sensible, but not relevant to competition motoring.

Some hose specialists have recently come up with complicated assemblies allowing the hoses to pass the test, but generally speaking, they are not suitable for high mileage road usage.

## Power Steering Hoses

Power steering systems have a pressure hose and a return hose. The pressure hose assemblies are subjected to the highest pressures found in vehicle usage. Only the smooth bore PTFE with stainless steel outer cover and Aeroquip FC300 single wire reinforced hose are suitable the latter being the most cost effective, flexible and because it has greater volumetric expansion (more give), less likely to produce noises caused by hydraulic hammer.

Aeroquip offer a limited range of reusable fittings mainly suited to American equipment for both hoses we offer the **MOCAL** TFE hose as a cheaper alternative to both, this uses Aeroquip TFE fittings. Original equipment hoses tend to have complex end fittings, we can sometimes re-swage old fittings to new hose, please supply fittings removed from hose together with a sketch showing lengths and orientation. Hoses to SAE 100R6 are suitable for return lines, fittings are usually clamped push in and part of the pump/box.

## Hard Lines In Aluminium Tube

Over the last few years there has been big interest in using aluminium tubing to replace flexible oil and fuel hoses for plumbing in competition cars. The most popular form of tube has a flexible Polyamide coating to prevent corrosion.

It is approximately half the weight of AQP racing hose and tighter bend radiuses can be achieved. Disadvantages are that they are more difficult to install and must be vibration free to prevent work hardening and subsequent cracking, also it goes a bit flat if you step on it.

There are various ways of attaching fittings:

1. The compression fitting, where a female nut and olive are slipped over the tube and tightened onto a female JIC or metric fitting in a similar fashion to a flexible hose fitting, like PTFE brake hose but unlike AQP racing hose they may be screwed direct to a range of specially made adapters.
2. The Aeroquip Versaflare flareless fitting which is similar to the above but can be tightened onto an AN adapter, the racing car industry standard. The fitting, coming from an industrial background, is made of steel and should only be screwed onto a steel adapter.
3. The Aeroquip tube nut and sleeve fitting made to aircraft specification in aluminium needs the tube to be flared, usually with an inexpensive portable flaring tool.
4. The shape memory flareless fitting, very high-tech aerospace technology where the olive is packed frozen in liquid nitrogen and shrinks onto the tube when exposed to the atmosphere. Currently too expensive but we are working on it.

## Hard Lines In Seamless Copper/Copper Alloy Or Steel Tube

Mainly used for brake and clutch lines where, due to its small size, the weight penalty is not too harsh Also quite suitable for fuel and oil lines where weight is not a big issue. The most popular is the double wrapped and brazed copper alloy Kunifer tube. At present ends must be flared with a special tool for assembly, unless the Aeroquip Versaflare is used on bigger sizes but we are working on a flareless system for brake/clutch installations.

## Understanding Hose & Fitting Sizes

Aeroquip racing hose and fittings are derived from AN (Air force Navy) specifications which refer to them by dash sizes, arrived at by multiplying the nominal bore of the hose by 16, hence 1/2" hose is -8. Aeroquip being an American company has extended this to cover British hose and fittings. Most threads including JIC (now called SAE 37°) & Metric are defined by the outer diameter of the male thread. However, BSP and NPTF are defined by the bore of the hose they fit, hence a 1/2BSP fitting fits a 1/2" hose. The system does not allow for variations, except in the case of specials, thus you rarely have different sizes of fitting on one size of hose. Adapters must be used to sort out such problems.

## Thread Chart

Measurements in inches, NPTF (taper threads) taken at mid point; tpi = threads per inch, OD = outside diameter of male thread, ID = the minor diameter or inside diameter of female thread. Metric threads, e.g. M12 x 1.5 are defined by diameter of male thread in mm (M12) x pitch in mm (1.5) the pitch is always half the thread depth. BSP and JIC fittings seal on a coned seating or if in a port with a washer or seal but NPTF (taper) fittings seal by slight deformation of the thread hence a satisfactory joint can be made between NPTF male and BSP ports. When using NPTF elbows tighten until pointing in the desired direction. PTFE tape may be used with NPTF threads.

Dash Size	BSP Thread	BSP OD	BSP ID	JIC Thread	JIC ID	NPTF Thread	NPTF OD	NPTF ID
-3	1/8 x 28 tpi	9.65mm	8.64mm	3/8 x 24 tpi	8.64mm	1/8 x 27 tpi	10.41mm	8.64mm
-4	1/4 19 tpi	13.21mm	11.43mm	7/16 x 20 tpi	10.16mm	1/4 x 18 tpi	14.22mm	11.94mm
-6	3/8 x 19 tpi	16.76mm	14.99mm	9/16 x 18 tpi	13.21mm	3/8 x 18 tpi	17.53mm	14.99mm
-8	1/2 x 14 tpi	21.08mm	18.29mm	3/4 x 16 tpi	17.78mm	1/2 x 14 tpi	21.34mm	18.92mm
-10	5/8 x 14 tpi	22.86mm	20.57mm	7/8 x 14 tpi	20.57mm	none	none	none
-12	3/4 x 14 tpi	26.42mm	24.13mm	1 1/16 x 12 tpi	25.15mm	3/4 x 14 tpi	26.92mm	23.88mm
-16	1 x 11 tpi	33.27mm	30.23mm	1 5/16 x 12 tpi	31.50mm	1 x 11.5 tpi	33.27mm	30.23mm

A guide to sizes most commonly used. Please consult for special applications.

Application	Bore	AQP dash no.	Type of hose
Flexible brake lines	1/8"	-3	2807/MOCAL TFE/666
Flexible clutch lines	3/16"	-4	2807/MOCAL TFE/666
Solid brake lines	3/16"		Kunifer/Aluminium Tube
Oil & fuel pressure gauges	3/16"	-3	2807/MOCAL TFE/Nylon
Fuel more than 8 mpg	5/16"	-5	FC333/MOCAL TFE/BS Au108
Fuel less than 8 mpg	3/8"	-6	FC333/FBN/FBV/MOCAL TFE/BS Au108
Fuel less than 2 mpg	1/2"	-8	FC333/FBN/FBV/MOCAL TFE/BS Au108
Vacuum servo, American designed equipment	1/2"		Servo
Vacuum servo, European spec	3/8"	-6	Servo hose
Automatic transmission	5/16"	-6	FC333/100R6/BS Au108
Power steering pressure side	3/8"	-6	2807/FC300
Power steering return	3/8"	-6	FBN/FBV/100R6
Oil cooler engines up to 2 litres	1/2"	-8	FC333/FBN/FBV/100R6
Oil cooler engines over 2 litres	5/8"	-10	FC333/FBN/FBV/100R6
Dry sump pressure side up to 2 litres	1/2"	-8	FC333/FBN/FBV/100R6
Dry sump pressure side over 2 litres	5/8"	-10	FC333/FBN/FBV/100R6
Dry sump scavenge side up to 2 litres	5/8"	-10	FC333/FBN/FBV/100R6
Dry sump scavenge side over 2 litres	3/4"	-12	FC333/FBN/FBV/100R6

For engine oil cooler and dry sump applications where hose run is over 3 metres, go up a size.

As an Aeroquip distributor we are able to supply a range of hoses, however for the purpose of this catalogue we listed only those most suitable for automobile applications.

In the following hose specifications, ID = inside diameter, OD = outside diameter in inches. Intermittent use at temperatures up 20% higher than listed is safe but will lead to more rapid hardening of the neoprene cover.

## MOCAL 100R6 Hose

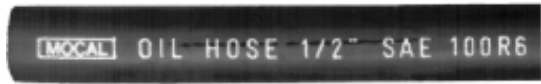

**MOCAL** 100R6/R9 hose and fittings offer a lower cost alternative to the Aeroquip push on, the fittings are lighter, the hose will accept tighter bend radiuses without kinking but unlike the Aeroquip product, separate means of assembly to the hose is required.

Construction: Elastomer inner tube, one textile braid reinforcement and elastomer outer cover in accordance with SAE 100R6 specification.

Performance: Temperature range -40°C to +120°C. 400 psi (27.5bar) working, 1600psi(110bar) burst pressure.

Application: For oil and coolant, ordinary fuel resistant.

### Dimensions & Bend Radius

Bore Size	Outside Dimension	Bend Radius
1/4"/6.4mm	0.50"/12.7mm	2.48"/63mm
5/16"/7.9mm	0.56"/14.3mm	2.95"/75mm
3/8"/9.8mm	0.63"/15.9mm	2.95"/75mm
1/2"/12.7mm	0.77"/19.8mm	3.94"/100mm
5/8"/15.9mm	0.91"/23.0mm	4.92"/125mm
3/4"/19mm	1.03"/27.0mm	5.31"/135mm

#### Part No

100R6-4	1/4in ID 100R6 Hose
100R6-5	5/16in ID 100R6 Hose
100R6-6	3/8in ID 100R6 Hose
100R6-8	1/2in ID 100R6 Hose
100R6-10	5/8in ID 100R6 Hose
100R6-12	3/4in ID 100R6 Hose

## Stainless Steel Braided MOCAL 100R6 Hoses

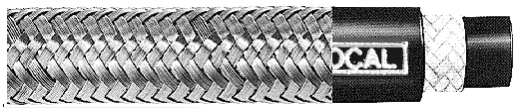

We can supply **MOCAL** 100R6 with a stainless steel braided cover.

Bore Size	Outside Diameter	Bend Radius
1/4"	0.51"/13.0mm	2.48"/63mm
5/16"	0.59"/15.0mm	2.95"/75mm
3/8"	0.67"/17.0mm	2.95"/75mm
1/2"	0.83"/21.0mm	3.94"/100mm
5/8"	0.95"/24.0mm	4.92"/125mm
3/4"	1.15"/29.0mm	5.31"/135mm

#### Part No

S100R6-4	1/4in ID Stainless braided 100R6 Hose
S100R6-5	5/16in ID Stainless braided 100R6 Hose
S100R6-6	3/8in ID Stainless braided 100R6 Hose
S100R6-8	1/2in ID Stainless braided 100R6 Hose
S100R6-10	5/8in ID Stainless braided 100R6 Hose
S100R6-12	3/4in ID Stainless braided 100R6 Hose

## MOCAL SAE J30 R9 Fuel Injection Hose



Black, flexible hose for fuel in automotive or engine application. High temperature hose with low permeation for petrol at less than 15g/m<sup>2</sup>/24hrs. Normally installed using crimped ferrules or petrol hose clips. Suitable for petrol, diesel, ethanol, gasoline, oxidised sour gas, oil and biodiesel.

Performance: Working temperature range -30°C to 130°C (int150°C)

### Dimensions & Bend Radius

Bore Size	Outside Dimension	Bend Radius
3/16"/4.8mm	0.46"/11.8mm	1.81"/46mm
7/32"/5.6mm	0.47"/12.0mm	2.05"/52mm
1/4"/6.3mm	0.5"/12.7mm	2.2"/56mm
9/32"/7.3mm	0.52"/13.2mm	2.36"/60mm
5/16"/7.9mm	0.57"/14.5mm	2.28"/58mm
3/8"/9.5mm	0.64"/16.5mm	2.44"/62mm
1/2"/12.7mm	0.78"/19.9mm	2.68"/68mm
5/8"/15.6mm	0.88"/22.4mm	2.99"/76mm

#### Part No

R9-M4.8	4.8mm ID R9 hose
R9-M5.6	5.6mm ID R9 hose
R9-M6.3	6.3mm ID R9 hose
R9-M7.3	7.3mm ID R9 hose
R9-M7.9	7.9mm ID R9 hose
R9-M9.5	9.5mm ID R9 hose
R9-M12.7	12.7mm ID R9 hose
R9-M15.6	15.6mm ID R9 hose

## Stainless Steel Braided MOCAL R9 Hoses

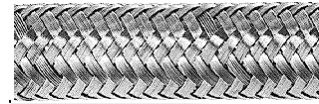

We can supply **MOCAL** R9 with a stainless steel braided cover.

Bore Size	Outside Dimension	Bend Radius
3/16" /4.8mm	0.48"/12.1mm	1.81"/46mm
7/32"/5.6mm	0.49"/12.3mm	2.05"/52mm
1/4"/6.3mm	0.51"/13mm	2.2"/56mm
9/32" 7.3mm	0.55"/13.9mm	2.36"/60mm
5/16"/ 7.9mm	0.6"/15.2mm	2.28"/58mm
3/8"/9.5mm	0.69"/17.6mm	2.44"/62mm
1/2"/12.7mm	0.83"/21.1mm	2.68"/68mm
5/8"/15.6mm	0.92"/23.4mm	2.99"/76mm

#### Part No

SR9-M4.8	4.8mm ID stainless braided R9 hose
SR9-M5.6	5.6mm ID stainless braided R9 hose
SR9-M6.3	6.3mm ID stainless braided R9 hose
SR9-M7.3	7.3mm ID stainless braided R9 hose
SR9-M7.9	7.9mm ID stainless braided R9 hose
SR9-M9.5	9.5mm ID stainless braided R9 hose
SR9-M12.7	12.7mm ID stainless braided R9 hose
SR9-M15.6	15.6mm ID stainless braided R9 hose

## Fittings For 100R6/R9 Hose

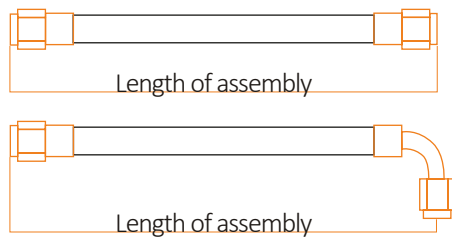

Construction: Mild steel with serrated shaft.

Application: Fittings are usually swaged to the hose at our factory. When ordering, measurements should be taken from mating face to mating face. If the assembly does not include a straight fitting, orientation of fittings may be specified, although the swaged ferrule may be clamped in a vice and the fitting rotated to the desired position. When required for on-site assembly use with a worm drive clamp tightened to 10 inch/pounds (1.2Nm), an O-clamp which is secured with pincers is a neat alternative, use a Proclamp if hose is wire braided. All these can be found on page 50 - 51. We can also supply Jiffy-tite quick-connect fittings see page 66.

### Male One Piece Straight



#### Steel

##### Part No

957	5/8UNF For 1/2in Hose
HEM1-11-8	11/16 X 20 TPI For 1/2in Hose
HEM3-4-8	1/4BSP For 1/2in Hose
HEM3-6-8	3/8BSP For 1/2in Hose (Aluminium)
HEM3-8	1/2BSP For 1/2in Hose
HEM3-8-10	1/2BSP For 5/8in Hose
HEM6-6-10	3/8BSP For 5/8in Hose
HEM7-10-8	-10 JIC For 1/2in Hose
HEM7-12	-12 JIC For 3/4in Hose
HEM8-4-8	1/4NPTF For 1/2in Hose
HEM8-6-8	3/8NPTF For 1/2in Hose
HEM8-6-8B	3/8NPTF For 1/2in Hose (Mini Automatic)
HEM2-55-10	M14x1.5 For 5/8in Hose
HEM2-55-8	M14x1.5 For 1/2in Hose
HEM2-65-8	M16x1.5 For 1/2in Hose
HEM2-65-10	M16x1.5 For 5/8in Hose
HEM2-85-8	M18x1.5 For 1/2in Hose

#### Aluminium

##### Part No

HEMA2-85-8	M18x1.5 Male For 1/2in Hose
------------	-----------------------------

Factory made swaged assemblies available.

### Female Swivel Straight



#### Steel

##### Part No

HEF3-8	1/2BSP For 1/2in Hose
HEF3-10	5/8BSP For 5/8in Hose
HEF3-12	3/4BSP For 3/4in Hose
HEF7-6	-6JIC For 3/8in Hose
HEF7-8	-8JIC For 1/2in Hose
HEF7-10-8	-10JIC For 1/2in Hose
HEF7-10	-10JIC For 5/8in Hose
HEF7-12	-12JIC For 3/4in Hose
HEF2-85	M18x1.5 24° Seat For 1/2in Hose
HEF2-125	M26x1.5 For 3/4in Hose
HEF2-165	M30x1.5 For 3/4in Hose

### Female Swivel 45°



#### Steel

##### Part No

HEF43-8	1/2BSP For 1/2in Hose
HEF43-10	5/8BSP For 5/8in Hose
HEF43-12	3/4BSP For 3/4in Hose
HEF47-8	-8JIC For 1/2in Hose
HEF47-10-8	-10JIC For 1/2in Hose
HEF47-10	-10JIC For 5/8in Hose
HEF47-12	-12JIC For 3/4in Hose
HEF42-85	M18x1.5 24° Seat For 1/2in Hose
HEF42-125	M26x1.5 For 3/4in Hose
HEF42-165	M30x1.5 For 3/4in Hose

### Female Swivel 90°



#### Steel

##### Part No

HEF93-8	1/2BSP For 1/2in Hose
HEF93L-8	1/2BSP Long Leg For 1/2in Hose
HEF93-10-8	5/8BSP For 1/2in Hose
HEF93-10	5/8BSP For 5/8in Hose
HEF93-12	3/4BSP For 3/4in Hose
HEF97-6	-6JIC For 3/8in Hose
HEF97-8	-8JIC For 1/2in Hose
HEF97-10-8	-10JIC For 1/2in Hose
HEF97-10	-10JIC For 5/8in Hose
HEF97-12	-12JIC For 3/4in Hose
HEF92-85	M18x1.5 24° Seat For 1/2in Hose
HEF92-125	M26x1.5 For 3/4in Hose
HEF92-165	M30x1.5 For 3/4in Hose

### Female Swivel 180°



#### Steel

##### Part No

HEF83-8	1/2BSP For 1/2in Hose
HEF83-10	5/8BSP For 5/8in Hose
HEF82-85	M18x1.5 24° Seat For 1/2in Hose

We can assemble hoses to order for one off applications or repeat orders where we would be happy to apply a part number for individual assemblies or kits.

## Fittings For 100R6/R9/SPH Hose

Assemble with swage ferrule, O clamp or worm drive clamp. We do not make any fittings for 11/32" bore hoses. Suitable for low pressure (up to 15psi) carburettor installations, automatic transmission coolers and power steering return pipes.

### Female straight



Part No	
HEF7-6-4	-6JIC Female Swivel Straight For 1/4in Hoses
HEF7-6-5	-6JIC Female Swivel Straight For 5/16in Hoses
HEF7-6	-6JIC Female Straight For 3/8in Hose
HEF3-4	1/4BSP Female Swivel Straight For 1/4in Hose
HEF3-6-5	3/8BSP Female Swivel Straight For 5/16in Hose
HEF3-6	3/8BSP Female Straight For 3/8in Hose
HEF2-55-5C	M14 Female Swivel Straight For 5/16in ID Hose
HEF2-125	M26 x 1.5 Female Straight for 3/4in Hose
HEF2-165	M30 x 1.5 Female Straight for 3/4in Hose
HEF2-165-16	M30 x 1.5 Female Straight 1in Hose
HEF2-55-4C	M14 x 1.5 Female for 6.8mm Hose
HEF2-55-5	M14 x 1.5 Female Straight for 5/16in Hose
HEF2-55-5C	M14 x 1.5 Female for 5/16in Hose
HEF2-55-5L	M14 x 1.5 Female Long Straight for 5/16in Hose
HEF2-65-5	M16 x 1.5 Female Straight for 5/16in Hose
HEF2-65-5C	M16 x 1.5 Concave Female Straight for 5/16in Hose
HEF2-65-6	M16 x 1.5 Female Straight for 3/8in Hose
HEF2-65-6C	M16 x 1.5 Concave Female for 3/8in Hose
HEF2-85	M18 x 1.5 Female Straight for 1/2in Hose

### Female 45°



Part No	
HEF47-6	-6JIC Female 45° For 3/8in Hose
HEF43-6	3/8BSP Female 45° For 3/8in Hose (A)
HEF42-125	M26 x 1.5 Female 45° for 3/4in Hose
HEF42-165	M30 x 1.5 Female 45° for 3/4in Hose
HEF42-165-16	M30 x 1.5 Female 45° for 1in Hose
HEF42-65-6	M16 x 1.5 Female 45° for 3/8in Hose
HEF42-85	M18 x 1.5 Female 45° for 1/2in Hose

### Female 90°



Part No	
HEF97-6-5	-6JIC Female Swivel 90° For 5/16in Hoses
HEF97-6-4	-6JIC Female 90° For 1/4in Hose
HEF97-6	-6JIC Female 90° For 3/8in Hose
HEF93-6-5	3/8BSP Female Swivel 90° For 5/16in Hoses
HEF93-6	3/8BSP Female 90° For 3/8in Hose
HEF93-8-5	1/2BSP Female Swivel 90° For 5/16in Hose
HEF92-105-10	M22 x 1.5 Female 90° for 5/8in Hose
HEF92-115-10	M24 x 1.5 Female 90° for 5/8in Hose
HEF92-125	M26 x 1.5 Female 90° for 3/4in Hose
HEF92-165	M30 x 1.5 Female 90° for 3/4in Hose
HEF92-165-16	M30 x 1.5 Female 90° for 1in Hose
HEF92-31-4mm	M10 x 1.0 CUX Female 90° for 4mm Hose
HEF92-55-5	M14 x 1.5 Female 90° for 5/16in Hose
HEF92-55-5F	Forged M14 x 1.5 Female 90° for 5/16in Hose
HEF92-65-4	M16 x 1.5 Female 90° for 1/4in Hose
HEF92-65-4F	Forged M16 x 1.5 Female 90° 1/4in Hose
HEF92-65-6	M16 x 1.5 Female 90° for 3/8in Hose
HEF92-85	M18 x 1.5 Female 90° for 1/2in Hose
HEF92-85-24C	M18 90° for 1/2in Hose 24 Degseat

### Female 180°



Part No	
HEF82-85	M18 x 1.5 Female 180° for 1/2in Hose

### Male Straight



Part No	
HEM8-3-5	1/8NPTF Male Straight For 5/16in Hose
HEM8-4-4	1/4NPTF Male Straight For 1/4in Hose
HEM8-4-5	1/4NPTF Male Straight For 5/16in Hose
HEM8-4-6	1/4NPTF Male Straight For 3/8in Hose
HEM8-3-3	3/8NPTF Male Straight For 3/8in Hose
HEM3-4-5	1/4BSP Male For 5/16in Hose
HEM3-6-5	3/8BSP Male For 5/16in Hose
HEM1-5-5	1/2UNF Male For 5/16in Hose
HEM2-31-5	M10 x 1 Male with 5/16 Tail
HEM2-41-5	M12 x 1 Male for 5/16in Hose
HEM2-45-4	M12 x 1.5 Male for 1/4in Hose
HEM2-55-10	M14 x 1.5 Male for 5/8in Hose
HEM2-55-5	M14 x 1.5 Male for 5/16in Hose
HEM2-55-8	M14 x 1.5 Male for 1/2in Hose
HEM2-65-10	M16 x 1.5 Male for 5/8in Hose
HEM2-65-6	M16 x 1.5 Male for 3/8in Hose
HEM2-65-8	M16 x 1.5 Male for 1/2in Hose
HEM2-85-10	M18 x 1.5 Male for 5/8in Hose
HEM2-85-8	M18 x 1.5 Male for 1/2in Hose

### Male 90°



Part No	
HEM98-3-2	1/8NPTF Male 90° For 3/16in Hose - Brass
HEM98-3-4	1/8NPTF Male 90° For 1/4in Hose - Brass
HEM98-3-5	1/8NPTF Male 90° For 5/16in Hose - Brass
HEM98-4-5	1/4NPTF Male 90° For 5/16in Hose - Brass
HEM98-4-6	1/4NPTF Male 90° For 3/8in Hose - Brass

### Banjo



Part No	
HEBAN-3-4	3/8in Banjo For 1/4in Hose
HEBAN-M8-3	M8 Banjo For 3/16in Hose
HEBAN-M8-4	M8 Banjo For 1/4in Hose
HEBAN-M10-4	M10 Banjo For 1/4in Hose
HEBAN-M10-5	M10 Banjo For 5/16in Hose
HEBAN-M12-4	M12 Banjo For 1/4in Hose
HEBAN-M12-5	M12 Banjo For 5/16in Hose
HEBAN-M12-6	M12 Banjo For 3/8in Hose
HEBAN-M14-4	M14 Banjo For 1/4in Hose
HEBAN-M14-5	M14 Banjo For 5/16in Hose
HEBAN-M14-6	M14 Banjo For 3/8in Hose
HEBAN-M16-6	M16 Banjo For 3/8in Hose
HEBAN-M16-8	M16 Banjo For 1/2in Hose
HEBAN-M18-6	M18 Banjo For 3/8in Hose
HEBAN-M18-8	M18 Banjo For 1/2in Hose
HEBAN-M18-10	M18 Banjo For 5/8in Hose
HEBAN-M22-12	M22 Banjo For 3/4in Hose

### Banjo 90°



Part No	
HEBAN2-41-5	Banjo For Webber Bolt With 90° For 5/16in Hose
HEBAN9-M12-5	M12 Banjo 90° For 5/16in Hose
HEBAN9-M14-6	M14 Banjo 90° For 3/8in Hose

### Banjo T



Part No	
HEBAN3-41-5-5	Banjo For Webber Bolt With T For 5/16in Hose



## Replacement Original Equipment Hoses



Hoses made to the same length and configuration as original equipment. These are assembled using **MOCAL100R6** hose and fittings.

We have the facility to manufacture small batch runs and have replicated many Porsche, Ferrari and Maseratti hoses. Whatever vehicle you have please send us a sample or drawing and we can quote for remanufacturing in a choice of hoses and styles.

Part No	
MGA1	MGA All - OEM Style Steel Tubes With Short Flexibles
AHH8192	MGB 1962-67 (2 Per Car)
AHH8536	MGB 1967-75 (Short Hose)
AHH8537	MGB 1967-75 (Long Hose)
BHH1610	MGB 1975 On (2 Per Car)
AHC323	MGC (Long Hose)
AHC324	MGC (Short Hose)
AHC335	MGC Auto Trans Cooler (2 Per Car)
BHH1104	MGB V8 All Models (Pump To Filter)
BHH1341	MGB V8 1973-75 (Filter To Cooler)
BHH1103	MGB V8 1973-75 (Pump To Cooler)
BHH1612	MGB V8 1975 On (Filter To Cooler)
BHH1613	MGB V8 1975 On (Pump To Cooler)
AHA8777	MG Midget - A-Healey Sprite - 1275cc (Long)
AHA8778	MG Midget - A-Healey Sprite - 1275cc (Short)
<b>NEW TO CATALOGUE</b>	
LOT90393482	Lotus Carlton/Omega oil cooler feed RH
LOT90393483	Lotus Carlton/Omega oil cooler return LH
LOT90393484	Lotus Carlton/Omega oil cooler link pipe
LOT90393485	Lotus Carlton/Omega oil cooler feed LH
LOT90393486	Lotus Carlton/Omega oil cooler return RH
<b>As Before - But With Stainless Steel Braided Hoses</b>	
AHH8192S	MGB 1962-67 (2 Per Car)
AHH8536S	MGB 1967-75 (Short Hose)
AHH8537S	MGB 1967-75 (Long Hose)
BHH1610S	MGB 1975 On (2 Per Car)
AHC323S	MGC (Long Hose)
AHC324S	MGC (Short Hose)

## Aeroquip "Push On Hose"

### AQP Socketless Hose



The push on or socketless hose and fittings are often overlooked in favour of our more exotic offerings but unless extremes of pressure, temperature and harsh environments are likely to be encountered this is the easiest to use and most cost effective hose available, see page 31 - 32. The specified high temperature and vacuum resistance far exceeds anything offered by others. Fitting is simple just push on the fitting to the hose, see page 89. Construction: AQP elastomer inner tube & outer covering, textile braid reinforcement with either black or blue outer. Application: Fuel, oil, air & water.

### Hose specification

Size	I.D. (inches/ mm)	O.D. (inches/ mm)	Max Pressure (psi)	Bend Radius (inches/ mm)	Vacuum Service (inch/HG)
-4	0.25/6.35	0.49/12.45	250	3/76.20	28
-6	0.38/9.65	0.62/15.75	250	3/76.20	28
-8	0.50/12.70	0.75/19.05	250	5/127	28
-10	0.63/16.00	0.91/23.11	250	6/152.4	18
-12	0.75/19.05	1.03/26.16	250	7/177.8	18

Temperature range	Oil °C	Water °C	Air °C
	-40°C to + 150°C	+82 °C	+120 °C

Size	Black	Blue
	Part No	Part No
-4	FBN0400	FBV0400
-6	FBN0600	FBV0600
-8	FBN0800	FBV0800
-10	FBN1000	FBV1000
-12	FBN1200	FBV1200

## Fittings For Push On Hoses

We offer 5 types of fitting.

1. The genuine Aeroquip product in plated steel, except their JIC straight fittings are brass, they have brass hose finishers for JIC, red plastic for BSP and black plastic for Metric.
2. The more cost effective but similar **MOCAL** steel fitting with red plastic finishers, available in JIC, BSP & Metric.
3. Aeroquip red and blue anodised, black anodised, or nickel plated aluminium fittings with matching finisher in JIC only.
4. The **MOCAL** JIC aluminium fittings are red and blue anodised but also available in black, please add BK to the end of the part number. The 45° and 90° versions are of compact design with tight radii for use where space is limited, use instead of forged fittings which have high pressure drops. The **MOCAL** BSP aluminium fittings are only available in Silver.
5. Jiffy-tite quick connect fittings, see page 69.

## Male Fitting

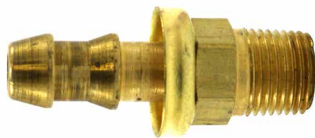

### Aeroquip Steel

Part No	
FBM1200	1/8NPTF For 1/4in Hose, Non Swivel
FBM1201	1/4NPTF For 1/4in Hose, Non Swivel
FBM1207	1/4NPTF For 3/8in Hose, Non Swivel
FBM1202	3/8NPTF For 3/8in Hose, Non Swivel
4738-6-6	3/8NPTF For 3/8in Hose, Non Swivel
4738-6-8	3/8NPTF For 1/2in Hose, Non Swivel
4738-8-8	1/2NPTF For 1/2in Hose, Non Swivel
FBM1211	7/16 X 24TPI For 1/4in Hose, Non Swivel
4742-5-4	1/2UNF For 1/4in Hose, Non Swivel

### MOCAL Steel

Part No	
HEMP6-3-4	1/8BSP For 1/4in Hose
HEMP3-6	3/8BSP For 3/8in Hose
HEMP3-8	1/2BSP For 1/2in Hose
HEMP3-10	5/8BSP For 5/8in Hose
HEMP3-12	3/4BSP For 3/4in Hose
HEMP7-4	-4JIC For 1/4in Hose
HEMP7-8	-8JIC For 1/2in Hose

### MOCAL Aluminium

Part No	
HEMAP2-105-6	M22 Male Swivel Straight For 3/8in Hose
HEMAP2-105-8	M22 Male Swivel Straight For 1/2in Hose
HEMAP2-105-10	M22 Male Swivel Straight For 5/8in Hose
HEMAP2-105-12	M22 Male Swivel Straight For 3/4in Hose
HEMAP42-105-6	M22 Male Swivel 45° For 3/8in Hose
HEMAP42-105-8	M22 Male Swivel 45° For 1/2in Hose
HEMAP42-105-10	M22 Male Swivel 45° For 5/8in Hose
HEMAP42-105-12	M22 Male Swivel 45° For 3/4in Hose
HEMAP92-105-6	M22 Male Swivel 90° For 3/8in Hose
HEMAP92-105-8	M22 Male Swivel 90° For 1/2in Hose
HEMAP92-105-10	M22 Male Swivel 90° For 5/8in Hose
HEMAP92-105-12	M22 Male Swivel 90° For 3/4in Hose

## Female Straight Swivel Fitting



### Aeroquip Aluminium

Part No	
FBM1512	-6JIC For 3/8in Hose, Red/Blue Anodised
FBM1513	-8JIC For 1/2in Hose, Red/Blue Anodised
FBM1514	-10JIC For 5/8in Hose, Red/Blue Anodised
FBM1515	-12JIC For 3/4in Hose, Red/Blue Anodised
FBL1512	-6JIC For 3/8in Hose, Black Anodised
FBL1513	-8JIC For 1/2in Hose, Black Anodised
FBL1514	-10JIC For 5/8in Hose, Black Anodised
FBL1515	-12JIC For 3/4in Hose, Black Anodised
FBE1512	-6JIC For 3/8in Hose, Nickel Plated
FBE1513	-8JIC For 1/2in Hose, Nickel Plated
FBE1514	-10JIC For 5/8in Hose, Nickel Plated
FBE1515	-12JIC For 3/4in Hose, Nickel Plated

### Aeroquip Steel

Part No	
07006-4-4	M12x1.5 For 1/4in Hose
07001-6-4	M14x1.5 For 1/4in Hose
07006-8-6	M16x1.5 For 3/8in Hose
07001-10-6	M18x1.5 For 3/8in Hose
07001-13-8	M22x1.5 For 1/2in Hose
07001-16-10	M26x1.5 For 5/8in Hose
07114-20-12	M30x1.5 For 3/4in Hose

### Aeroquip Brass

Part No	
FBM1222	-6JIC For 3/8in Hose
FBM1233	-8JIC For 1/2in Hose
FBM1234	-10JIC For 5/8in Hose
FBM1225	-12JIC For 3/4in Hose

### MOCAL Steel

Part No	
HEFP3-4	1/4BSP For 1/4in Hose
HEFP3-4-6	1/4BSP For 3/8in Hose
HEFP3-6	3/8BSP For 3/8in Hose
HEFP3-8	1/2BSP For 1/2in Hose
HEFP3-10	5/8BSP For 5/8in Hose
HEFP3-12	3/4BSP For 3/4in Hose
HEFP7-4	-4JIC For 1/4in Hose
HEFP7-6	-6JIC For 3/8in Hose
HEFP7-8	-8JIC For 1/2in Hose
HEFP7-8-6	-8JIC For 3/8in Hose
HEFP7-10	-10JIC For 5/8in Hose
HEFP7-10-8	-10JIC For 1/2in Hose
HEFP7-12	-12JIC For 3/4in Hose

### MOCAL Aluminium

Part No	
HEFAP3-8	1/2BSP For -8 Hose
HEFAP3-10	5/8BSP For -10 Hose
HEFAP7-4	-4JIC For 1/4in Hose
HEFAP7-6	-6JIC For 3/8in Hose
HEFAP7-8	-8JIC For 1/2in Hose
HEFAP7-10	-10JIC For 5/8in Hose
HEFAP7-12	-12JIC For 3/4in Hose

## Female 45° Swivel Fitting



### Aeroquip Aluminium

Part No	
FBM1522	-6JIC For 3/8in Hose, Red/Blue Anodised
FBM1523	-8JIC For 1/2in Hose, Red/Blue Anodised
FBM1524	-10JIC For 5/8in Hose, Red/Blue Anodised
FBM1525	-12JIC For 3/4in Hose, Red/Blue Anodised
FBL1522	-6JIC For 3/8in Hose, Black Anodised
FBL1523	-8JIC For 1/2in Hose, Black Anodised
FBL1524	-10JIC For 5/8in Hose, Black Anodised
FBL1525	-12JIC For 3/4in Hose, Black Anodised
FBE1522	-6JIC For 3/8in Hose, Nickel Plated
FBE1523	-8JIC For 1/2in Hose, Nickel Plated
FBE1524	-10JIC For 5/8in Hose, Nickel Plated
FBE1525	-12JIC For 3/4in Hose, Nickel Plated

### Aeroquip Steel

Part No	
07072-4-4	M12x1.5 For 1/4in Hose
07072-8-6	M16x1.5 For 3/8in Hose
07072-13-8	M22x1.5 For 1/2in Hose
07072-16-10	M26x1.5 For 5/8in Hose
FBM1438	-4JIC For 1/4in Hose
FBM1439	-6JIC For 3/8in Hose
FBM1440	-8JIC For 1/2in Hose

### MOCAL Steel

Part No	
HEFP43-4	1/4BSP For 1/4in Hose
HEFP43-6	3/8BSP For 3/8in Hose
HEFP43-8	1/2BSP For 1/2in Hose
HEFP43-10	5/8BSP For 5/8in Hose
HEFP43-12	3/4BSP For 3/4in Hose
HEFP47-4	-4JIC For 1/4in Hose
HEFP47-6	-6JIC For 3/8in Hose
HEFP47-8	-8JIC For 1/2in Hose
HEFP47-10	-10JIC For 5/8in Hose
HEFP47-12	-12JIC For 3/4in Hose

### MOCAL Aluminium

Part No	
HEFAP47-6	-6JIC For 3/8in Hose, Compact Red/Blue Anodised
HEFAP47-8	-8JIC For 1/2in Hose, Compact Red/Blue Anodised
HEFAP47-10	-10JIC For 5/8in Hose, Compact Red/Blue Anodised
HEFAP47-12	-12JIC For 3/4in Hose, Compact Red/Blue Anodised
HEFAP47-6BK	-6JIC For 3/8in Hose, Compact Black Anodised
HEFAP47-8BK	-8JIC For 1/2in Hose, Compact Black Anodised
HEFAP47-10BK	-10JIC For 5/8in Hose, Compact Black Anodised
HEFAP47-12BK	-12JIC For 3/4in Hose, Compact Black Anodised
HEFAP43-8	1/2BSP For 1/2in Hose, Compact
HEFAP43-10	5/8BSP For 5/8in Hose, Compact

## Female 90° Swivel Fitting



### Aeroquip Aluminium

Part No	
FBM1532	-6JIC For 3/8in Hose, Red/Blue Anodised
FBM1533	-8JIC For 1/2in Hose, Red/Blue Anodised
FBM1534	-10JIC For 5/8in Hose, Red/Blue Anodised
FBM1535	-12JIC For 3/4in Hose, Red/Blue Anodised
FBL1532	-6JIC For 3/8in Hose, Black Anodised
FBL1533	-8JIC For 1/2in Hose, Black Anodised
FBL1534	-10JIC For 5/8in Hose, Black Anodised
FBL1535	-12JIC For 3/4in Hose, Black Anodised
FBE1532	-6JIC For 3/8in Hose, Nickel Plated
FBE1533	-8JIC For 1/2in Hose, Nickel Plated
FBE1534	-10JIC For 5/8in Hose, Nickel Plated
FBE1535	-12JIC For 3/4in Hose, Nickel Plated

### Aeroquip Steel

Part No	
07074-4-4	M12x1.5 For 1/4in Hose
07074-6-4	M14x1.5 For 1/4in Hose
07074-8-6	M16x1.5 For 3/8in Hose
07074-10-6	M18x1.5 For 3/8in Hose
07074-13-8	M22x1.5 For 1/2in Hose
07074-16-10	M26x1.5 For 5/8in Hose
07075-20-12	M30x1.5 For 3/4in Hose
FBM1441	-4JIC For 1/4in Hose
FBM1442	-6JIC For 3/8in Hose
FBM1443	-8JIC For 1/2in Hose

### MOCAL Steel

Part No	
HEFP93-4	1/4BSP For 1/4in Hose
HEFP93-6	3/8BSP For 3/8in Hose
HEFP93-8	1/2BSP For 1/2in Hose
HEFP93-10	5/8BSP For 5/8in Hose
HEFP93-12	3/4BSP For 3/4in Hose
HEFP97-4	-4JIC For 1/4in Hose
HEFP97-6	-6JIC For 3/8in Hose
HEFP97-8	-8JIC For 1/2in Hose
HEFP97-10	-10JIC For 5/8in Hose
HEFP97-12	-12JIC For 3/4in Hose

### MOCAL Aluminium

Part No	
HEFAP97-4	-4JIC For 1/4in Hose, Compact Red/Blue Anodised
HEFAP97-6	-6JIC For 3/8in Hose, Compact Red/Blue Anodised
HEFAP97-8	-8JIC For 1/2in Hose, Compact Red/Blue Anodised
HEFAP97-10	-10JIC For 5/8in Hose, Compact Red/Blue Anodised
HEFAP97-12	-12JIC For 3/4in Hose, Compact Red/Blue Anodised
HEFAP97-4BK	-4JIC For 1/4in Hose, Compact Black Anodised
HEFAP97-6BK	-6JIC For 3/8in Hose, Compact Black Anodised
HEFAP97-8BK	-8JIC For 1/2in Hose, Compact Black Anodised
HEFAP97-10BK	-10JIC For 5/8in Hose, Compact Black Anodised
HEFAP97-12BK	-12JIC For 3/4in Hose, Compact Black Anodised
HEFAP93-8	1/2BSP For 1/2in Hose
HEFAP93-10	5/8BSP For 5/8in Hose

## Female 120° Swivel Fitting



### Aeroquip Aluminium

Part No	
FBM1542	-6JIC For 3/8in Hose, Red/Blue Anodised
FBM1543	-8JIC For 1/2in Hose, Red/Blue Anodised
FBM1544	-10JIC For 5/8in Hose, Red/Blue Anodised
FBM1545	-12JIC For 3/4in Hose, Red/Blue Anodised

### Aeroquip Aluminium

Part No	
FBL1542	-6JIC For 3/8in Hose, Black Anodised
FBL1543	-8JIC For 1/2in Hose, Black Anodised
FBL1544	-10JIC For 5/8in Hose, Black Anodised
FBL1545	-12JIC For 3/4in Hose, Black Anodised

### MOCAL Aluminium

Part No	
HEFAP27-6	-6JIC For 3/8in Hose Red/Blue Anodised
HEFAP27-8	-8JIC For 1/2in Hose Red/Blue Anodised
HEFAP27-10	-10JIC For 5/8in Hose Red/Blue Anodised
HEFAP27-12	-12JIC For 3/4in Hose Red/Blue Anodised
HEFAP27-6BK	-6JIC For 3/8in Hose Black Anodised
HEFAP27-8BK	-8JIC For 1/2in Hose Black Anodised
HEFAP27-10BK	-10JIC For 5/8in Hose Black Anodised
HEFAP27-12BK	-12JIC For 3/4in Hose Black Anodised

## Female 150° Swivel Fitting



### Aeroquip Aluminium

Part No	
FBM1552	-6JIC For 3/8in Hose, Red/Blue Anodised
FBM1553	-8JIC For 1/2in Hose, Red/Blue Anodised
FBM1554	-10JIC For 5/8in Hose, Red/Blue Anodised
FBM1555	-12JIC For 3/4in Hose, Red/Blue Anodised
FBL1552	-6JIC For 3/8in Hose, Black Anodised
FBL1553	-8JIC For 1/2in Hose, Black Anodised
FBL1554	-10JIC For 5/8in Hose, Black Anodised
FBL1555	-12JIC For 3/4in Hose, Black Anodised

### MOCAL Aluminium

Part No	
HEFAP57-6	-6JIC For 3/8in Hose
HEFAP57-8	-8JIC For 1/2in Hose
HEFAP57-10	-10JIC For 5/8in Hose
HEFAP57-12	-12JIC For 3/4in Hose
HEFAP57-6BK	-6JIC For 3/8in Hose Black Anodised
HEFAP57-8BK	-8JIC For 1/2in Hose Black Anodised
HEFAP57-10BK	-10JIC For 5/8in Hose Black Anodised
HEFAP57-12BK	-12JIC For 3/4in Hose Black Anodised

## Female 180° Swivel Fitting



### Aeroquip Aluminium

Part No	
FBM1562	-6JIC For 3/8in Hose, Red/Blue Anodised
FBM1563	-8JIC For 1/2in Hose, Red/Blue Anodised
FBM1564	-10JIC For 5/8in Hose, Red/Blue Anodised
FBM1565	-12JIC For 3/4in Hose, Red/Blue Anodised
FBL1562	-6JIC For 3/8in Hose, Black Anodised
FBL1563	-8JIC For 1/2in Hose, Black Anodised
FBL1564	-10JIC For 5/8in Hose, Black Anodised
FBL1565	-12JIC For 3/4in Hose, Black Anodised

### MOCAL Aluminium

Part No	
HEFAP87-6	-6JIC For 3/8in Hose Hose, Red/Blue Anodised
HEFAP87-8	-8JIC For 1/2in Hose Hose, Red/Blue Anodised
HEFAP87-10	-10JIC For 5/8in Hose Hose, Red/Blue Anodised
HEFAP87-12	-12JIC For 3/4in Hose Hose, Red/Blue Anodised
HEFAP87-6BK	-6JIC For 3/8in Hose, Black Anodised
HEFAP87-8BK	-8JIC For 1/2in Hose, Black Anodised
HEFAP87-10BK	-10JIC For 5/8in Hose, Black Anodised
HEFAP87-12BK	-12JIC For 3/4in Hose, Black Anodised

## Aeroquip FC333 Hose



AQP elastomer tube, partial stainless steel inner braid and a full stainless steel outer braid reinforcement.

Hose to fitting assembly is achieved by a simple threading together operation. Fittings are reusable and ideal for on-site assembly. See page 88 for assembly instructions.

Suitable for all fluids in automotive applications except brake pressure lines (use TFE/2807). Also see Oil and fuel hoses page 27

Complies with FIA regulations. Used by professional teams who will only consider the best for fuel, oil and air jack systems.

Temperature range -49°C to +150°C. Pressure capabilities vary with dimensions see chart below.

Part No	Hose I.D. inch/mm	Hose O.D. inch/mm	Working Pressure	Burst Pressure	Bend Radius	Vacuum Rating
FBA0400	0.22/5.59	0.44/11.18	1000psi	6000psi	2.0"	21
FBA0600	0.34/8.64	0.55/13.97	1000psi	6000psi	2.5"	21
FBA0800	0.44/11.18	0.65/16.51	1000psi	5000psi	3.5"	21
FBA1000	0.56/14.22	0.80/20.32	1000psi	5000psi	4.0"	28
FBA1200	0.69/17.53	0.94/23.88	1000psi	4000psi	4.5"	28
FBA1600	0.88/22.35	1.15/29.21	750psi	3000psi	5.5"	28
FBA2000	1.13/28.70	1.41/35.81	500psi	2000psi	8.0"	21
FBA2400	1.34/34.04	1.70/43.18	50psi	200psi	9.0"	21
FBA3200	1.75/44.45	2.09/53.09	50psi	200psi	12.5"	15

Part No	
FBA0400	Aeroquip -4 FC333 Stainless Steel Hose
FBA0600	Aeroquip -6 FC333 Stainless Steel Hose
FBA0800	Aeroquip -8 FC333 Stainless Steel Hose
FBA1000	Aeroquip -10 FC333 Stainless Steel Hose
FBA1200	Aeroquip -12 FC333 Stainless Steel Hose
FBA1600	Aeroquip -16 FC333 Stainless Steel Hose
FBA2000	Aeroquip -20 FC333 Stainless Steel Hose
FBA2400	Aeroquip -24 FC333 Stainless Steel Hose
FBA3200	Aeroquip -32 FC333 Stainless Steel Hose

## Aeroquip Startlite Hose



Special AQP neoprene inner tube, reinforced with fire retardant woven Nomex and Kevlar cover. Colour is black without tracer. Use where light weight is a primary concern, over 11% lighter than any other hose. Very little heat dissipation through hose which can be handled whilst containing oil at 100°C. Unlike convoluted TFE hoses, hose bore is smooth. The cover is highly abrasion resistant. 300% more than any comparable hose. To achieve greatest weight saving specify the special swaged silver and red fittings, see page 36. For on-site assembly use the familiar red and blue fittings originally designed for FC333 racing hose. The fittings are now also available finished in all black anodise or all nickel plate. All sizes of this hosing have a vacuum service rating of 20inches per HG.

## Performance & Dimensions

Part No	Hose I.D. inch/mm	Hose O.D. inch/mm	Working Pressure	Bend Radius	Weight kg/m	Vacuum Rating
FBU0400	0.22/5.59	0.43/10.92	500psi	2.0"	70	20
FBU0600	0.34/8.64	0.55/13.97	500psi	2.5"	120	20
FBU0800	0.44/11.18	0.64/16.26	500psi	3.5"	160	20
FBU1000	0.56/14.22	0.80/20.32	500psi	4.0"	200	20
FBU1200	0.69/17.53	0.93/23.62	300psi	4.5"	240	20
FBU1600	0.88/22.35	1.15/29.21	300psi	5.5"	370	20
FBU2000	1.13/28.70	1.41/35.81	300psi	5.5"	400	20

Part No	
FBU0400	Aeroquip -4 Startlite Hose
FBU0600	Aeroquip -6 Startlite Hose
FBU0800	Aeroquip -8 Startlite Hose
FBU1000	Aeroquip -10 Startlite Hose
FBU1200	Aeroquip -12 Startlite Hose
FBU1600	Aeroquip -16 Startlite Hose

## GRH MOCAL Racing Hose



A high performance racing hose compatible with Aeroquip and similar reusable fittings. Stainless steel reinforced rubber inner tube and stainless steel braided outer. Resistant to oils, fuels, coolant and alcohols. Temperature range -49°C to +149°C.

Part No	Hose I.D. inch/mm	Hose O.D. inch/mm	Working Pressure	Burst Pressure	Bend Radius	Weight g/m
GRH-4	0.22/5.56	0.44/11.17	500psi	2000psi	2.0"	105
GRH-6	0.34/8.64	0.56/14.22	500psi	2000psi	2.5"	235
GRH-8	0.44/11.18	0.67/17.02	500psi	2000psi	3.5"	260
GRH-10	0.56/14.22	0.82/20.83	500psi	2000psi	4.0"	325
GRH-12	0.69/17.53	0.96/24.38	350psi	1400psi	4.5"	405
GRH-16	0.88/22.35	1.15/29.21	350psi	1400psi	5.5"	610

Part No	
GRH-4	<b>MOCAL</b> -4 Stainless Steel Racing Hose
GRH-6	<b>MOCAL</b> -6 Stainless Steel Racing Hose
GRH-8	<b>MOCAL</b> -8 Stainless Steel Racing Hose
GRH-10	<b>MOCAL</b> -10 Stainless Steel Racing Hose
GRH-12	<b>MOCAL</b> -12 Stainless Steel Racing Hose
GRH-16	<b>MOCAL</b> -16 Stainless Steel Racing Hose

## G210 MOCAL Racing Hose



As above with black braided nylon outer.

Part No	Hose I.D. inch/mm	Hose O.D. inch/mm	Working Pressure	Burst Pressure	Bend Radius	Weight g/m
G210-4	0.22/5.56	0.44/11.17	500psi	2000psi	2.0"	105
G210-6	0.34/8.64	0.56/14.22	500psi	2000psi	2.5"	235
G210-8	0.44/11.18	0.67/17.02	500psi	2000psi	3.5"	260
G210-10	0.56/14.22	0.82/20.83	500psi	2000psi	4.0"	325
G210-12	0.69/17.53	0.96/24.38	350psi	1400psi	4.5"	405
G210-16	0.88/22.35	1.15/29.21	350psi	1400psi	5.5"	610

Part No	
G210-4	<b>MOCAL</b> -4 Black Racing Hose
G210-6	<b>MOCAL</b> -6 Black Racing Hose
G210-8	<b>MOCAL</b> -8 Black Racing Hose
G210-10	<b>MOCAL</b> -10 Black Racing Hose
G210-12	<b>MOCAL</b> -12 Black Racing Hose
G210-16	<b>MOCAL</b> -16 Black Racing Hose

## Reusable Fittings For FC333, Startlite & G210 Hose

Construction: Aluminium, red and blue or black anodised or nickel plated for JIC, black and gold for metric. Aeroquip have compression fitting. Others have double cutter fitting see page 27. A vice and adjustable spanner are all that is needed to assemble to hose. All fittings are double swivel but Aeroquip fittings are available single swivel for those who prefer lightness and simplicity. Steel fittings are available for use with methanol or nitro methane fuels which can corrode aluminium. We can also supply Jiffy-tite quick-connect fittings see page 66.

### Female Straight Swivel Fittings



#### MOCAL Red & Blue

Part No	
HEFA7-6	-6JIC Double Cutter
HEFA7-8	-8JIC Double Cutter
HEFA7-10	-10JIC Double Cutter
HEFA7-12	-12JIC Double Cutter

#### MOCAL Black

Part No	
HEFA2-45-6	M12x1.5 For -6 Hose
HEFA2-55-6	M14x1.5 For -6 Hose
HEFA2-65-6	M16x1.5 For -6 Hose
HEFA2-85-8	M18x1.5 For -8 Hose
HEFA2-115-10	M22x1.5 For -10 Hose
HEFA2-125-12	M26x1.5 For -12 Hose
HEFAF2-165-12	M30x1.5 For -12 Hose
HEFAF2-165-16	M30x1.5 For -16 Hose

#### Aeroquip Black

Part No	
FBM4412	-6JIC Compression Style
FBM4413	-8JIC Compression Style
FBM4414	-10JIC Compression Style
FBM4415	-12JIC Compression Style
FBM4416	-16JIC Compression Style

#### Aeroquip Nickel

Part No	
FBE1012	-6JIC Compression Style
FBE1013	-8JIC Compression Style
FBE1014	-10JIC Compression Style
FBE1015	-12JIC Compression Style

#### Aeroquip Red & Blue

Part No	
FBM1011	-4JIC Compression (Red Nut With Steel Body)
FBM1012	-6JIC Compression Style
FBM1013	-8JIC Compression Style
FBM1014	-10JIC Compression Style
FBM1015	-12JIC Compression Style
FBM1016	-16JIC Compression Style
FBM1017	-20JIC Compression Style

### Female 30° Swept Tube Fittings



#### Aeroquip Red & Blue

Part No	
FBM4072	-6JIC Double Swivel
FBM4073	-8JIC Double Swivel
FBM4074	-10JIC Double Swivel
FBM4075	-12JIC Double Swivel
FBM4076	-16JIC Double Swivel
FBM1147	-20JIC Single Swivel

#### Aeroquip Black

Part No	
FBM4472	-6JIC Double Swivel
FBM4473	-8JIC Double Swivel
FBM4474	-10JIC Double Swivel
FBM4475	-12JIC Double Swivel
FBM4476	-16JIC Double Swivel

### Female 45° Swept Tube Fittings



#### Aeroquip Red & Blue

Part No	
FBM1021	-4JIC Single Swivel (Red Nut With Steel Body)
FBM4022	-6JIC Double Swivel
FBM4023	-8JIC Double Swivel
FBM4024	-10JIC Double Swivel
FBM4025	-12JIC Double Swivel
FBM4026	-16JIC Double Swivel
FBM1027	-20JIC Single Swivel

#### Aeroquip Black

Part No	
FBM4422	-6JIC Double Swivel
FBM4423	-8JIC Double Swivel
FBM4424	-10JIC Double Swivel
FBM4425	-12JIC Double Swivel
FBM4426	-16JIC Double Swivel

#### Aeroquip Nickel

Part No	
FBE4022	-6JIC Double Swivel
FBE4023	-8JIC Double Swivel
FBE4024	-10JIC Double Swivel
FBE4025	-12JIC Double Swivel

### Female 60° Swept Tube Fittings



#### Aeroquip Red & Blue

Part No	
FBM4082	-6JIC Double Swivel
FBM4083	-8JIC Double Swivel
FBM4084	-10JIC Double Swivel
FBM4085	-12JIC Double Swivel
FBM4086	-16JIC Double Swivel
FBM1148	-20JIC Single Swivel

#### Aeroquip Black

Part No	
FBM4482	-6JIC Double Swivel
FBM4483	-8JIC Double Swivel
FBM4484	-10JIC Double Swivel
FBM4485	-12JIC Double Swivel
FBM4486	-16JIC Double Swivel

### Female 90° Swept Tube Fittings



#### Aeroquip Red & Blue

Part No	
FBM1031	-4JIC Single Swivel (Red Nut With Steel Body)
FBM4032	-6JIC Double Swivel
FBM4033	-8JIC Double Swivel
FBM4034	-10JIC Double Swivel
FBM4035	-12JIC Double Swivel
FBM4036	-16JIC Double Swivel
FBM1037	-20JIC Single Swivel

#### Aeroquip Black

Part No	
FBM4432	-6JIC Double Swivel
FBM4433	-8JIC Double Swivel
FBM4434	-10JIC Double Swivel
FBM4435	-12JIC Double Swivel
FBM4436	-16JIC Double Swivel

#### Aeroquip Nickel

Part No	
FBE4032	-6JIC Double Swivel
FBE4033	-8JIC Double Swivel
FBE4034	-10JIC Double Swivel
FBE4035	-12JIC Double Swivel

## Female 120° Swept Tube Fittings



### Aeroquip Red & Blue

Part No	
FBM4042	-6JIC Double Swivel
FBM4043	-8JIC Double Swivel
FBM4044	-10JIC Double Swivel
FBM4045	-12JIC Double Swivel
FBM4046	-16JIC Double Swivel

### Aeroquip Black

Part No	
FBM4442	-6JIC Double Swivel
FBM4443	-8JIC Double Swivel
FBM4444	-10JIC Double Swivel
FBM4445	-12JIC Double Swivel
FBM4446	-16JIC Double Swivel

## Female 150° Swept Tube Fittings



### Aeroquip Red & Blue

Part No	
FBM4052	-6JIC Double Swivel
FBM4053	-8JIC Double Swivel
FBM4054	-10JIC Double Swivel
FBM4055	-12JIC Double Swivel
FBM4056	-16JIC Double Swivel

### Aeroquip Black

Part No	
FBM4452	-6JIC Double Swivel
FBM4453	-8JIC Double Swivel
FBM4454	-10JIC Double Swivel
FBM4455	-12JIC Double Swivel
FBM4456	-16JIC Double Swivel

## Female 180° Swept Tube Fittings



### Aeroquip Red & Blue

Part No	
FBM4062	-6JIC Double Swivel
FBM4063	-8JIC Double Swivel
FBM4064	-10JIC Double Swivel
FBM4065	-12JIC Double Swivel
FBM4066	-16JIC Double Swivel

### Aeroquip Black

Part No	
FBM4462	-6JIC Double Swivel
FBM4463	-8JIC Double Swivel
FBM4464	-10JIC Double Swivel
FBM4465	-14JIC Double Swivel
FBM4466	-16JIC Double Swivel

## MOCAL Compact Swept Bend Fittings

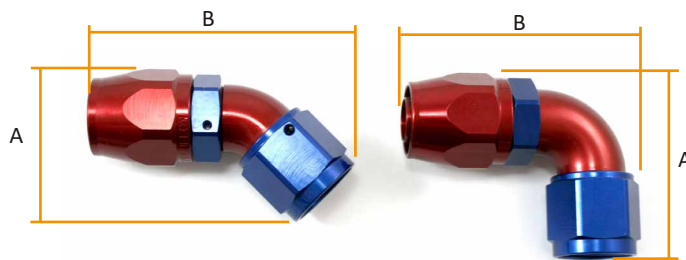

A new concept made possible by advanced manufacturing techniques, the compact fitting has not only the small envelope of the forged fitting but also the strength due to the consistent wall thickness and one piece construction. All aluminium, double swivel, anodised red and blue or black (add BK to the part number).

### Dimensions

	90 Degree Fitting		45 Degree Fitting	
	Dim A in inches	Dim B in inches	Dim A in inches	Dim B in inches
-6JIC	1.4	1.9	2.4	1.5
-8JIC	1.8	2.4	2.6	1.7
-10JIC	2.2	2.7	3.0	2.2
-12JIC	2.4	3.1	3.2	2.3

### 45°

Part No	
HEFA4C7-6DS	-6JIC Compact
HEFA4C7-8DS	-8JIC Compact
HEFA4C7-10DS	-10JIC Compact
HEFA4C7-12DS	-12JIC Compact

### 90°

Part No	
HEFA9C7-6DS	-6JIC Compact
HEFA9C7-8DS	-8JIC Compact
HEFA9C7-10DS	-10JIC Compact
HEFA9C7-12DS	-12JIC Compact

## Male Fittings



Fit to NPTF and M22 female ports

### Straight

Part No	
HEMA2-105-6	M22 Male Swivel For -6 Hose
HEMA2-105-8	M22 Male Swivel For -8 Hose
HEMA2-105-10	M22 Male Swivel For -10 Hose
HEMA2-105-12	M22 Male Swivel For -12 Hose

### 45°

Part No	
HEMA42-105-6	M22 Male Swivel For -6 Hose
HEMA42-105-8	M22 Male Swivel For -8 Hose
HEMA42-105-10	M22 Male Swivel For -10 Hose
HEMA42-105-12	M22 Male Swivel For -12 Hose

### 90°

Part No	
HEMA92-105-6	M22 Male Swivel For -6 Hose
HEMA92-105-8	M22 Male Swivel For -8 Hose
HEMA92-105-10	M22 Male Swivel For -10 Hose
HEMA92-105-12	M22 Male Swivel For -12 Hose
FBM1343	3/8NPTF For -6 Hose Double Swivel - Aeroquip
FBM1344	1/2NPTF For -8 Hose Double Swivel - Aeroquip
FBM1345	3/4NPTF For -12 Hose Double Swivel - Aeroquip

## Metric Forged Or Block Fittings

Forged fittings will cause considerable pressure drop by comparison with swept tube fittings. For JIC fittings we recommend compact swept fittings. All forged fittings are double swivel and double cutter.

### Female 45° Forged Fittings



Part No	
HEFA4F2-45-6	M12x1.5 For -6 Hose
HEFA4F2-55-6	M14x1.5 For -6 Hose
HEFA4F2-65-6	M16x1.5 For -6 Hose
HEFA4F2-85-8	M18x1.5 For -8 Hose
HEFA4F2-115-10	M22x1.5 For -10 Hose
HEFA4F2-125-12	M26x1.5 For -12 Hose
HEFA4F2-165-12	M30x1.5 For -12 Hose
HEFA4F2-165-16	M30x1.5 For -16 Hose

### Female 90° Forged Fittings



Part No	
HEFA9F2-45-6	M12x1.5 For -6 Hose
HEFA9F2-55-6	M14x1.5 For -6 Hose
HEFA9F2-65-6	M16x1.5 For -6 Hose
HEFA9F2-85-8	M18x1.5 For -8 Hose
HEFA9F2-115-10	M22x1.5 For -10 Hose
HEFA9F2-125-12	M26x1.5 For -12 Hose
HEFA9F2-165-12	M30x1.5 For -12 Hose
HEFA9F2-165-16	M30x1.5 For -16 Hose

## Swaged Fittings For FC333, Startlite



For ultimate weight saving, swaged on fittings must be used. These fittings are aluminium, anodised red and silver with plain aluminium ferrules. Swaging can be carried out at our factory.

### Straight

Part No	
FBM4212	-6JIC Female Straight
FBM4213	-8JIC Female Straight
FBM4214	-10JIC Female Straight
FBM4215	-12JIC Female Straight
FBM4216	-16JIC Female Straight
FBM4217	-20JIC Female Straight

### 45°

Part No	
FBM4222	-6JIC Female Double Swivel
FBM4223	-8JIC Female Double Swivel
FBM4224	-10JIC Female Double Swivel
FBM4225	-12JIC Female Double Swivel
FBM4226	-16JIC Female Double Swivel
FBM4127	-20JIC Female Single Swivel

### 90°

Part No	
FBM4232	-6JIC Female Double Swivel
FBM4233	-8JIC Female Double Swivel
FBM4234	-10JIC Female Double Swivel
FBM4235	-12JIC Female Double Swivel
FBM4236	-16JIC Female Double Swivel
FBM4137	-20JIC Female Single Swivel

### 120°

Part No	
FBM4242	-6JIC Female Double Swivel
FBM4243	-8JIC Female Double Swivel
FBM4244	-10JIC Female Double Swivel
FBM4245	-12JIC Female Double Swivel
FBM4246	-16JIC Female Double Swivel

### 150°

Part No	
FBM4252	-6JIC Female Double Swivel
FBM4253	-8JIC Female Double Swivel
FBM4254	-10JIC Female Double Swivel
FBM4255	-12JIC Female Double Swivel
FBM4256	-16JIC Female Double Swivel

### 180°

Part No	
FBM4263	-8JIC Female Double Swivel
FBM4264	-10JIC Female Double Swivel
FBM4265	-12JIC Female Double Swivel

## Dual Feed Assemblies For Holley Double Pumper Carburettors



Assembly features a capped -4JIC male to facilitate fitting of a fuel gauge, if a smaller bore is required use a -3JIC male/female adapter (Part No MFA1-3-6).

Part No	
FCP0101	-6 For Holley 800/850 9.25 Bowl Centres
FCP0134	-8 For Holley 800/850 9.25 Bowl Centres
FCP0102	-6 For Holley 600/650 8.62 Bowl Centres
FCP0129	-6 For Holley 4010/4011 8.25 Bowl Centres

## Carburettor Banjo Fittings



We recommend that banjo fittings are only used for non viscous fluids or, if in oil installations, where flow restrictions are not important. Very neat Weber installations can be made combining the above with banjo adapters on page 60. The fittings listed come complete with bolts and washers. The **MOCAL** fittings listed below are sold without bolts & washers. See page 60 for bolts, and 70 for washers.

Part No	
FBM1067	Weber M12x1.5 For -6 Hose
FBM1068	Double As Above
FBM1066	Holley 9/16-24For -6 Hose
FBM1069	Double As Above
FBM1070	Solex/Dellorto M12x1.25 For -6 Hose
BAR2-7	To Convert Above For Dellorto Downdraft With M7 Nut
WEB1	Weber Banjo 90° Hose End Including Bolt
WEB2	Weber Banjo T Hose End Including Bolt
WEB3	Weber Banjo T Hose End Male Including Bolt
WEB1BK	Weber Banjo 90° Hose End Including Bolt
WEB2BK	Weber Banjo T Hose End Including Bolt
WEB3BK	Weber Banjo T Hose End Male Including Bolt

## Banjo Fittings



Part No	
HEBANA-M12-6	M12 For -6 Hose
HEBANA-M14-6	M14 For -6 Hose
HEBANA1-M14-6	M14 For -6 Hose - Extended
HEBANA-M16-6	M16 For -6 Hose
HEBANA1-M16-6	M16 For -6 Hose - Extended
HEBANA-M18-6	M18 For -6 Hose
HEBANA-M22-6	M22 For -6 Hose
HEBANA-M14-8	M14 For -8 Hose
HEBANA2-65-8	M16 For -8 Hose
HEBANA-M18-8	M18 For -8 Hose

## ProGold Hose

A light weight hose suitable for racing applications. This is a convoluted hose with a composite construction inner core of PTFE reinforced with impregnated glass fibre wrapped on a mandrel. The outer covering can be either stainless steel braiding or, for lightness, High temperature polymer braid or the cost effective polyester braid.

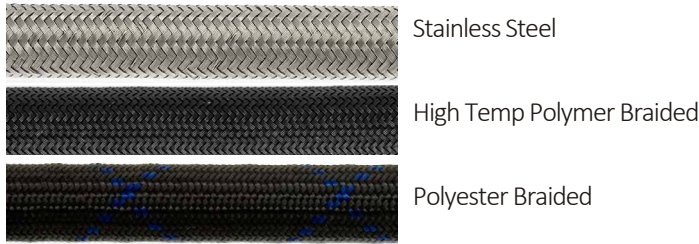

### Performance & Dimensions

Stainless steel braided. Temperature range -54°C to +204°C. Max working pressure 500psi.

Part No	Hose I.D. inch/mm	Hose O.D. inch/mm	Vacuum	Weight kg/m	Bend Radius
AR - 06 - S	0.36/9.14	0.54/13.72	28in/Hg	0.09	1.00"
AR - 08 - S	0.43/10.92	0.62/15.75	28in/Hg	0.10	1.50"
AR - 10 - S	0.54/13.72	0.75/19.05	28in/Hg	0.15	2.00"
AR - 12 - S	0.66/16.76	0.88/22.35	28in/Hg	0.17	2.50"
AR - 16 - S	0.87/22.10	1.08/27.43	28in/Hg	0.23	3.50"

High temperature polymer braided. Temperature range -54°C to 200°C. Max working pressure 250psi.

Part No	Hose I.D. inch/mm	Hose O.D. inch/mm	Vacuum	Weight kg/m	Bend Radius
AR - 06 - HTP	0.36/9.14	0.54/13.72	28in/Hg	0.09	1.00"
AR - 08 - HTP	0.43/10.92	0.62/15.75	28in/Hg	0.10	1.50"
AR - 10 - HTP	0.54/13.72	0.75/19.05	28in/Hg	0.15	2.00"
AR - 12 - HTP	0.66/16.76	0.88/22.35	20in/Hg	0.17	2.50"
AR - 16 - HTP	0.87/22.10	1.08/27.43	10in/Hg	0.23	3.50"

Polyester braided. Temperature range -54°C to 125°C. Max working pressure 250psi except -16 = 150psi. All dimensions as HTP braided.

#### Stainless Steel

Part No	
AR-06-S	Stainless Steel Braided Hose -6
AR-08-S	Stainless Steel Braided Hose -8
AR-10-S	Stainless Steel Braided Hose -10
AR-12-S	Stainless Steel Braided Hose -12
AR-16-S	Stainless Steel Braided Hose -16

#### High Temperature Polymer

Part No	
AR-06-HTP	High Temperature Polymer Braided Hose -6
AR-08-HTP	High Temperature Polymer Braided Hose -8
AR-10-HTP	High Temperature Polymer Braided Hose -10
AR-12-HTP	High Temperature Polymer Braided Hose -12
AR-16-HTP	High Temperature Polymer Braided Hose -16

#### Polyester

Part No	
AR-06-P	Polyester Braided Hose -6
AR-08-P	Polyester Braided Hose -8
AR-10-P	Polyester Braided Hose -10
AR-12-P	Polyester Braided Hose -12
AR-16-P	Polyester Braided Hose -16

## Fittings For ProGold Hose

Fittings are aluminium with anodised blue fittings and gold nuts/ferrules. Elbows have one piece bends (not brazed) and the double swivel rotates in the housing not hose. ProGold AR fittings are reusable, always use a new olive, see instructions on page 90. ProGold AC fittings are swaged at our factory with the assembly being lighter. Replace 3 with 4 for black fittings e.g. AC-06-F3 becomes AC-06-F4.

### Female Straight Swivel Fittings



Part No	
AC-06-F3	-6JIC Crimped
AC-08-F3	-8JIC Crimped
AC-10-F3	-10JIC Crimped
AC-12-F3	-12JIC Crimped
AC-16-F3	-16JIC Crimped
AR-06-F3	-6JIC Reuseable Blue & Gold Only
AR-08-F3	-8JIC Reuseable Blue & Gold Only
AR-10-F3	-10JIC Reuseable Blue & Gold Only
AR-12-F3	-12JIC Reuseable Blue & Gold Only
AR-16-F3	-16JIC Reuseable Blue & Gold Only
AR-06-ST-M12	M12x1.5 Reuseable For -6 Hose Blue & Gold Only
AR-06-ST-M14	M14x1.5 Reuseable For -6 Hose Blue & Gold Only
AR-06-ST-M16	M16x1.5 Reuseable For -6 Hose Blue & Gold Only
AR-08-ST-M18	M18x1.5 Reuseable For -8 Hose Blue & Gold Only
AR-10-ST-M22	M22x1.5 Reuseable For -10 Hose Blue & Gold Only
AR-12-ST-M26	M26x1.5 Reuseable For -12 Hose Blue & Gold Only
AR-16-ST-M30	M30x1.5 Reuseable For -16 Hose Blue & Gold Only

### Female 30° Elbow JIC Swivel Fittings



Part No	
AC-06-30JIC-3	-6JIC Crimped
AC-08-30JIC-3	-8JIC Crimped
AC-10-30JIC-3	-10JIC Crimped
AC-12-30JIC-3	-12JIC Crimped
AC-16-30JIC-3	-16JIC Crimped

### Female 45° Elbow JIC Swivel Fittings

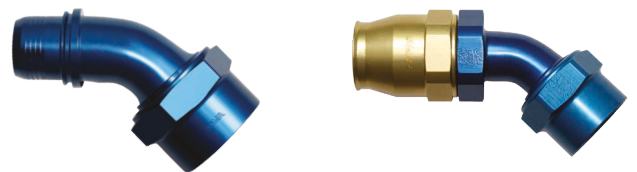

Part No	
AC-06-G3	-6JIC Crimped
AC-08-G3	-8JIC Crimped
AC-10-G3	-10JIC Crimped
AC-12-G3	-12JIC Crimped
AC-16-G3	-16JIC Crimped
AR-06-G3	-6JIC Reuseable
AR-08-G3	-8JIC Reuseable
AR-10-G3	-10JIC Reuseable
AR-12-G3	-12JIC Reuseable
AR-16-G3	-16JIC Reuseable
AR-06-45-M12	M12x1.5 Reuseable For -6 Hose
AR-06-45-M14	M14x1.5 Reuseable For -6 Hose
AR-06-45-M16	M16x1.5 Reuseable For -6 Hose
AR-08-45-M18	M18x1.5 Reuseable For -8 Hose
AR-10-45-M22	M22x1.5 Reuseable For -10 Hose



## Female 60° Elbow JIC Swivel Fittings



### Part No

AC-06-60JIC-3	-6JIC Crimped
AC-08-60JIC-3	-8JIC Crimped
AC-10-60JIC-3	-10JIC Crimped
AC-12-60JIC-3	-12JIC Crimped
AC-16-60JIC-3	-16JIC Crimped

## Female 150° Elbow JIC Swivel Fittings



### Part No

AC-06-R3	-6JIC Crimped
AC-08-R3	-8JIC Crimped
AC-10-R3	-10JIC Crimped
AC-12-R3	-12JIC Crimped
AC-16-R3	-16JIC Crimped

## Female 90° Elbow JIC Swivel Fittings

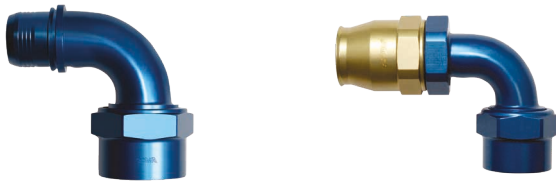

### Part No

AC-06-H3	-6JIC Crimped
AC-08-H3	-8JIC Crimped
AC-10-H3	-10JIC Crimped
AC-12-H3	-12JIC Crimped
AC-16-H3	-16JIC Crimped
AR-06-H3	-6JIC Reuseable
AR-08-H3	-8JIC Reuseable
AR-10-H3	-10JIC Reuseable
AR-12-H3	-12JIC Reuseable
AR-16-H3	-16JIC Reuseable
AR-06-90-M12	M12x1.5 Reuseable For -6 Hose
AR-06-90-M14	M14x1.5 Reuseable For -6 Hose
AR-06-90-M16	M16x1.5 Reuseable For -6 Hose
AR-08-90-M18	M18x1.5 Reuseable For -8 Hose
AR-10-90-M22	M22x1.5 Reuseable For -10 Hose

## Female 30° Elbow JIC Double Swivel Fittings



### Part No

AC-06-30JICDS-3	-6JIC Crimped
AC-08-30JICDS-3	-8JIC Crimped
AC-10-30JICDS-3	-10JIC Crimped
AC-12-30JICDS-3	-12JIC Crimped
AC-16-30JICDS-3	-16JIC Crimped

## Female 45° Elbow Double Swivel JIC Fittings



## Female 120° Elbow JIC Swivel Fittings



### Part No

AC-06-P3	-6JIC Crimped
AC-08-P3	-8JIC Crimped
AC-10-P3	-10JIC Crimped
AC-12-P3	-12JIC Crimped
AC-16-P3	-16JIC Crimped

### Part No

AC-06-G3-DS	-6JIC Crimped
AC-08-G3-DS	-8JIC Crimped
AC-10-G3-DS	-10JIC Crimped
AC-12-G3-DS	-12JIC Crimped
AC-16-G3-DS	-16JIC Crimped
AR-06-G3-DS	-6JIC Reuseable
AR-08-G3-DS	-8JIC Reuseable
AR-10-G3-DS	-10JIC Reuseable
AR-12-G3-DS	-12JIC Reuseable
AR-16-G3-DS	-16JIC Reuseable
AR-12-45-M26-DS	M26x1.5 Reuseable For -12 Hose
AR-16-45-M30-DS	M30x1.5 Reuseable For -16 Hose

## Female 60° Elbow JIC Double Swivel Fittings



### Part No

AC-06-60JICDS-3	-6JIC Crimped
AC-08-60JICDS-3	-8JIC Crimped
AC-10-60JICDS-3	-10JIC Crimped
AC-12-60JICDS-3	-12JIC Crimped
AC-16-60JICDS-3	-16JIC Crimped

## Female 90° Elbow JIC Double Swivel Fittings

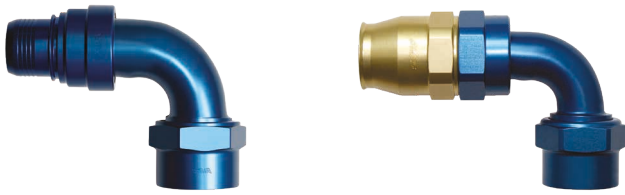

### Part No

AC-06-H3-DS	-6JIC Crimped
AC-08-H3-DS	-8JIC Crimped
AC-10-H3-DS	-10JIC Crimped
AC-12-H3-DS	-12JIC Crimped
AC-16-H3-DS	-16JIC Crimped
AR-06-H3-DS	-6JIC Reuseable
AR-08-H3-DS	-8JIC Reuseable
AR-10-H3-DS	-10JIC Reuseable
AR-12-H3-DS	-12JIC Reuseable
AR-16-H3-DS	-16JIC Reuseable
AR-12-90-M26-DS	M26x1.5 Reuseable For -12 Hose
AR-16-90-M30-DS	M30x1.5 Reuseable For -16 Hose

## Female 180° Elbow JIC Double Swivel Fittings



### Part No

AC-06-S3-DS	-6JIC Crimped
AC-08-S3-DS	-8JIC Crimped
AC-10-S3-DS	-10JIC Crimped
AC-12-S3-DS	-12JIC Crimped
AC-16-S3-DS	-16JIC Crimped
AR-06-S3-DS	-6JIC Reuseable
AR-08-S3-DS	-8JIC Reuseable
AR-10-S3-DS	-10JIC Reuseable
AR-12-S3-DS	-12JIC Reuseable
AR-16-S3-DS	-16JIC Reuseable

## Female 120° Elbow JIC Double Swivel Fittings



### Part No

AC-06-P3-DS	-6JIC Crimped
AC-08-P3-DS	-8JIC Crimped
AC-10-P3-DS	-10JIC Crimped
AC-12-P3-DS	-12JIC Crimped
AC-16-P3-DS	-16JIC Crimped
AR-06-P3-DS	-6JIC Reuseable
AR-08-P3-DS	-8JIC Reuseable
AR-10-P3-DS	-10JIC Reuseable
AR-12-P3-DS	-12JIC Reuseable
AR-16-P3-DS	-16JIC Reuseable

## Banjo Fittings

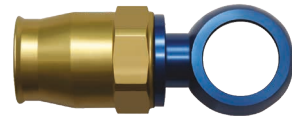

### Part No

AR-06-BJ-01	9/16 UNF For -6 Hose
AR-06-BJ-02	M12x1.25 For -6 Hose
AR-06-BJ-D02	M12x1.25 Double For -6 Hose
AR-06-BJ-03	M12x1.50 For -6 Hose
AR-06-BJ-04	M14x1.50 For -6 Hose

## Replacement Olives & Sockets For AR Fittings



### Part No

AR-O-06	-6 Olive
AR-O-08	-8 Olive
AR-O-10	-10 Olive
AR-O-12	-12 Olive
AR-O-16	-16 Olive
AR-S-06	-6 Socket Gold Only
AR-S-08	-8 Socket Gold Only
AR-S-10	-10 Socket Gold Only
AR-S-12	-12 Socket Gold Only
AR-S-16	-16 Socket Gold Only

## Female 150° Elbow JIC Double Swivel Fittings



### Part No

AC-06-R3-DS	-6JIC Crimped
AC-08-R3-DS	-8JIC Crimped
AC-10-R3-DS	-10JIC Crimped
AC-12-R3-DS	-12JIC Crimped
AC-16-R3-DS	-16JIC Crimped
AR-06-R3-DS	-6JIC Reuseable
AR-08-R3-DS	-8JIC Reuseable
AR-10-R3-DS	-10JIC Reuseable
AR-12-R3-DS	-12JIC Reuseable
AR-16-R3-DS	-16JIC Reuseable

This represents a small selection of the fittings available, if you require something that isn't listed please ask as we are continually adding to our range.

## Stainless Braided TFE Hose

### Aeroquip TFE Racing Hose/2807



Extruded Teflon tube with stainless steel single wire braid cover. Available in -2 to -16 sizes. A high pressure hose with excellent fluid compatibility and a stainless steel cover that is resistant to corrosion and abrasion. Especially on sizes greater than 3/8" bore does not have the same flexibility as FC333 racing hose. Due to its very low ratio of expansion to pressure, this hose has proved to be ideal for use on flexible lines in competition vehicle braking and clutch systems providing a desirable hard pedal with reduced travel. It does not conform to existing standards laid down for normal road vehicles, if subjected to continuous flexing the stainless steel strands will eventually fracture and could penetrate the Teflon liner, however this eventuality does not occur within the normal life of a competition vehicle, this hose in common with all other components used on such vehicles should be regularly inspected for signs of wear. The hose is also suitable for oil pressure gauge lines, fuel injection pipes, power steering hoses and, because of its high temperature capabilities, on turbo charger oil feed and return lines. Temperature range -73°C to +232°C.

Part No	Hose I.D. inch/mm	Hose O.D. inch/mm	Working Pressure	Burst Pressure	Bend Radius
FBC0300	0.13/3.30	0.25/6.35	3000psi	12000psi	1.50"
FBC0400	0.19/4.83	0.30/7.62	3000psi	12000psi	2.00"
FBC0600	0.32/8.13	0.42/10.67	2500psi	10000psi	4.00"
FBC0800	0.42/10.67	0.54/13.72	2000psi	8000psi	5.25"

Sizes - Available from -3 to -16 but only -3,-4,-6 and -8 are relevant to vehicle applications. -3 is used for brake hose applications, -4 for clutch due to greater fluid transfer requirements and for turbo charger feeds, -6 & -8 for power steering and turbo charger drains.

### Aeroquip 666 Aerospace Hose

Part No	
2807-3	FBC0300 -3 Hose
2807-4	FBC0400 -4 Hose
2807-6	FBC0600 -6 Hose
2807-8	FBC0800 -8 Hose

Similar to above but made to closer tolerances and tested to Military standards. The Teflon liner is electrically conductive to prevent electrostatic failures, non conductive may be ordered. Available in -3 to -24 sizes. Only -3 is the same size as 2807/TFE and its imitators. Use standard fittings in -3, -4 requires different sleeve, so assembly has different part no, -6 and up have different fittings. Fittings are also available with aluminium nipple (main body) and stainless socket and sleeve in -4 and above.

### MOCAL TFE Hose

Part No	
AE240-3	-3 Hose
666-4	-4 Hose
666-6	-6 Hose

TFE hose with stainless steel outer braid has many industrial uses and is manufactured as such in the UK and is compatible with Aeroquip and MOCAL fittings, we offer such a hose because of its extremely competitive price and suitability for competition vehicle use. Available in all sizes -2 to -8 from stock. We can offer a PVC skin for this hose for added protection and easy wipe cleaning,, Skin must be cut back to take fitting.

Available colours

Part No	
TFE2	-2 Hose
TFE3	-3 Hose
TFE3B	-3 Hose With PVC Cover - Black
TFE3O	-3 Hose With Cover - Orange
TFE3PINK	-3 Hose With Cover - Pink
TFE3R	-3 Hose With Cover - Red
TFE3Y	-3 Hose With Cover - Yellow
TFECAR3	-3 Hose With Cover - Carbon Look-A-Like
TFEPVC3	-3 Hose With PVC Outer - Clear
TFEPVC3BLU	-3 Hose With PVC Outer - Blue
TFEPVC3G	-3 Hose With PVC Outer - Green
TFEPVC3BLUE	-3 Hose With PVC Cover - Translucent Blue
TFEPVC3TRED	-3 Hose With PVC Cover - Translucent Red
TFEPVC4	-4 Hose With PVC Outer
TFE4	-4 Hose
TFE4C	-4 Hose Conductive
TFE6	-6Hose
TFE6C	-6 Hose Conductive
TFE8	-8 Hose
TFE8C	-8 Hose Conductive

### Fittings For 2807/ TFE Racing Hose, 666 & MOCAL TFE Hoses

Function: The fittings are available in swaged or reusable form. Reusable fittings can be assembled using a vice and suitable spanner. Use up to 3 times before replacing sleeve. Construction: Three piece fittings consisting of a nipple, sleeve and socket. Aeroquip manufacture a large range of Super Gem female fittings in mild steel, stainless steel and aluminium with stainless socket.

There is a demand for specialised fittings not covered by this range, which are manufactured by us on our state of the art CNC machinery and supplied complete with the relevant Aeroquip sleeve and socket, we call these MOCAL fittings. Fittings are usually mild steel, cadmium plated, but can be chrome plated. Stainless steel fittings can be supplied and the more popular are listed.

### Female Straight Fittings



#### Aeroquip Plated Steel

Part No	
FBM1100	-3JIC For -3 Hose
FBM1101	-4JIC For -4 Hose
FBM1103	-6JIC For -6 Hose
FBM1104	-8JIC For -8 Hose
FBM1134	-6SAE For -6 Hose
FBM1135	-8SAE For -8 Hose

#### Aeroquip Stainless Steel

Part No	
FBM1130	-3JIC For -3 Hose
FBM1102	-4JIC For -4 Hose Except 666-4

#### MOCAL Plated Steel

Part No	
HETF7-3	-3JIC For -3 Hose
HETF7-4	-4JIC For -4 Hose
HETF7-4-3	-4JIC For -3 Hose
E321-3	1/8BSP For -3 Hose
E321-3G	1/8BSP Straight With Flat Seat For Gauge -3 TFE Hose
E321-4	1/4BSP For -4 Hose
E321-6	3/8BSP For -6 Hose
E321-8	1/2BSP For -8 Hose
HETF2-31	M10x1 For -3 Hose
HETF2-31X	M10x1 For -3 Hose, Convex
HETF2-35	M10x1.5 For -3 Hose

#### MOCAL Aluminium

Part No	
HETFA7-3	-3JIC For -3 Hose (Black & Blue)
HETFA7-4	-4JIC For -4 Hose (Black & Blue)
HETFA7-6	-6JIC For -6 Hose (Black & Blue)
HETFA7-8	-8JIC For -8 Hose (Black & Blue)
HETAF2-31X	M10x1.0 For -3 Hose (Black & Gold)
HETAF2-45-4	M12x1.5 For -4 Hose (Black & Gold)
HETAF2-55-6	M14x1.5 For -6 Hose (Black & Gold)

#### MOCAL Stainless Steel

Part No	
HETSSF7-3	-3JIC For -3 Hose

## Female 45° Fittings



### Aeroquip Plated Steel Swept

#### Part No

FBM1110	-3JIC For -3 Hose Single Swivel
FBM1111	-4JIC For -4 Hose Single Swivel
FBM1112	-6JIC For -6 Hose Single Swivel
FBM1113	-8JIC For -8 Hose Single Swivel
FBM1114	-6SAE For -6 Hose Single Swivel

### Aeroquip Stainless Steel Forged Or Block

#### Part No

FBM1140	-3JIC For -3 Hose All Stainless - Double Swivel
FBM1146	-4JIC For -4 Hose All Stainless - Double Swivel
F6633-4	-4JIC For 666-4 Hose Only All Stainless - Double Swivel

### MOCAL Plated Steel Swept

#### Part No

E331-3	1/8BSP For -3 Hose Single Swivel
E331-3G	1/8BSP 45° With Flat Seat For Gauge -3 TFE Hose Swivel
E331-4	1/4BSP For -4 Hose Single Swivel
E331-6	3/8BSP For -6 Hose Single Swivel
E331-8	1/2BSP For -8 Hose Single Swivel
HETF42-31	M10x1 For -3 Hose Single Swivel (Black & Gold)
HETF47-3	-3JIC For -3 Hose Single Swivel

### MOCAL Aluminium Forged Or Block

#### Part No

HETAFA7-3	-3JIC For -3 Hose Double Swivel (Black & Blue)
HETAFA7-4	-4JIC For -4 Hose Double Swivel (Black & Blue)

### MOCAL Aluminium Swept

#### Part No

HETAFA7-6	-6JIC For -6 Hose Double Swivel (Black & Blue)
HETAFA7-8	-8JIC For -8 Hose Double Swivel (Black & Blue)

### MOCAL Stainless Steel Forged Or Block

#### Part No

HETSSF47-3	-3JIC For -3 Hose All Stainless
------------	---------------------------------

## Female 90° Fittings



### Aeroquip Plated Steel Swept

#### Part No

FBM1120	-3JIC For -3 Hose Single Swivel
FBM1121	-4JIC For -4 Hose Single Swivel
FBM1122	-6JIC For -6 Hose Single Swivel
FBM1123	-8JIC For -8 Hose Single Swivel
FBM1136	-6SAE For -6 Hose Single Swivel

### Aeroquip Stainless Steel Forged Or Block

#### Part No

FBM1150	-3JIC For -3 Hose All Stainless - Double Swivel
FBM1151	-4JIC For -4 Hose All Stainless - Double Swivel
F6605-4	-4JIC For 666-4 Hose Only All Stainless - Double Swivel

### MOCAL Plated Steel Swept

#### Part No

E332-3	1/8BSP For -3 Hose Single Swivel
E332-3G	1/8BSP With Flat Seat For Pressure Gauge -3 Hose
E332-4	1/4BSP For -4 Hose Single Swivel
E332-6	3/8BSP For -6 Hose Single Swivel
E332-8	1/2BSP For -8 Hose Single Swivel
HETF92-31	M10x1 For -3 Hose Single Swivel (Black & Gold)
HETF97-3	-3JIC For -3 Hose Single Swivel

### MOCAL Aluminium Forged Or Block

#### Part No

HETAFA97-3	-3JIC For -3 Hose - Double Swivel (Black & Blue)
HETAFA97-4	-4JIC For -4 Hose - Double Swivel (Black & Blue)

### MOCAL Aluminium Swept

#### Part No

HETAFA97-6	-6JIC For -6 Hose Double Swivel (Black & Blue)
HETAFA97-8	-8JIC For -8 Hose Double Swivel (Black & Blue)

### MOCAL Stainless Steel Forged Or Block

#### Part No

HETSSF97-3	-3JIC For -3 Hose Single Swivel
------------	---------------------------------

## Female 120° Fittings



### MOCAL Aluminium Swept

#### Part No

HETAFA27-3	-3JIC For -3 Hose Double Swivel (Black & Blue)
HETAFA27-4	-4JIC For -4 Hose Double Swivel (Black & Blue)
HETAFA27-6	-6JIC For -6 Hose Double Swivel (Black & Blue)
HETAFA27-8	-8JIC For -8 Hose Double Swivel (Black & Blue)

### MOCAL Plated Steel Swept

#### Part No

HETSF27-3	-3JIC For -3 Hose Single Swivel
HETSF27-4	-4JIC For -4 Hose Single Swivel

## Female 150° Fittings



### MOCAL Aluminium Swept

#### Part No

HETAFA57-4	-4JIC For -4 Hose Double Swivel (Black & Blue)
HETAFA57-6	-6JIC For -6 Hose Double Swivel (Black & Blue)
HETAFA57-8	-8JIC For -8 Hose Double Swivel (Black & Blue)

### MOCAL Stainless Steel Swept

#### Part No

HETSSF57-3	-3JIC For -3 Hose Single Swivel
HETSSF57-4	-4JIC For -4 Hose Single Swivel

## Female 180° Fittings



### MOCAL Aluminium Swept

#### Part No

HETAFA87-4	-4JIC For -4 Hose Double Swivel (Black & Blue)
HETAFA87-6	-6JIC For -6 Hose Double Swivel (Black & Blue)
HETAFA87-8	-8JIC For -8 Hose Double Swivel (Black & Blue)

### MOCAL Stainless Steel Swept

#### Part No

HETSF87-3	-3JIC For -3 Hose Single Swivel
HETSSF87-3	-3JIC For -3 Hose Single Swivel
HETSSF87-4	-4JIC For -4 Hose Single Swivel

## MOCAL Male Fittings



Non swivel, direct fitting into callipers, master and wheel cylinders. Convex & concave seal on bottom of port. Flat use washers under hexagon.

### MOCAL Plated Steel

Part No	
HET1-3	3/8UNF Flat - .37 Under Hex For -3 Hose
HETX1-3	3/8UNF Convex Seat- .50 Under Hex For -3 Hose
HETC1-3	3/8UNF Concave Seat- .37 Under Hex For -3 Hose
HET2-31	M10x1.0 Flat- .37 Under Hex For -3 Hose
HETC2-31	M10x1.0 Concave Seat- .37 Under Hex For -3 Hose
HETX2-31	M10x1.0 Convex Seat- .57 Under Hex For -3 Hose
HET2-32	M10x1.25 Flat- .37 Under Hex For -3 Hose
HET8-3	1/8NPTF For -3 Hose
HET1-4	7/16UNF Flat For -4 Hose
HET2-41	M12x1.0 Flat For -4 Hose

### MOCAL Stainless Steel

Part No	
HETSS1-3	3/8UNF Flat/Convex Seat For -3 Hose
HETSS2-31	M10 X 1 Concave Seat For -3 Hose

## MOCAL Male Bulkhead Fittings

Circlip



Threaded



See page 62 for locknuts & page 70 for lock washers.

### MOCAL Plated Steel

Part No	
HETB1-3	3/8UNF For -3 Hose Threaded
HETB2-31	M10x1 For -3 Hose Threaded
HETBC2-31	M10x1 For -3 Hose Circlip
HETB-4-3	7/16UNF For -3 Hose Threaded
HETB1-4	7/16UNF For -4 Hose Threaded
HETB2-41	M12x1 For -4 Hose Threaded

### MOCAL Stainless Steel

Part No	
HETSSB1-3	3/8UNF For -3 Hose
HETSSB2-31	M10 X 1 For -3 Hose

## MOCAL Bulkhead Fittings With Bleed Screw

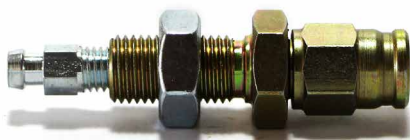

### MOCAL Plated Steel

Part No	
HETBB1-3	3/8UNF For -3 Hose With Locknut

## MOCAL female bulkhead fittings

Porsche type (P) Circlip



Thread type (CT)



Circlip type (C)



Non swivel, takes 5/8Whitx26 nut or original snap clip, direct fitting onto metal brake pipes with male nuts. See page 62 for locknuts & page 70 for lock washers.

## MOCAL Plated Steel

Part No	
HETBF1-3	3/8UNF Concave Seat For -3 Hose (CT)
HETBFX1-3	3/8UNF Convex Seat For -3 Hose (CT)
HETBF2-31	M10x1 Concave Seat For -3 Hose (CT)
HETBFX1-31	M10x1 Convex Seat For -3 Hose (CT)
HETBFC2-31V	M10x1 Concave Seat For -3 Hose (C)
HETBFC2-31X	M10x1 Convex Seat For -3 Hose (C)
HETBFP2-31	M10x1 Concave Seat Porsche Type For -3 Hose (P)
HETBF2-32	M10x1.25 Concave Seat For -3 Hose (CT)
HETBFX2-32	M10x1.25 Convex Seat For -3 Hose (CT)
HETBFC2-32	M10x1.25 Concave Seat For -3 Hose (C)
HETBFC2-32X	M10x1.25 Convex Seat For -3 Hose (C)
HETBF1-4-3	7/16UNF Concave Seat For -3 Hose (CT)
HETBF1-4	7/16UNF Concave Seat For -4 Hose (CT)
HETBFX1-4	7/16UNF Convex Seat For -4 Hose (CT)
HETBF2-41-3	M12x1 Concave Seat For -3 Hose (CT)
HETBF2-41-3X	M12x1 Convex Seat For -3 Hose (CT)
HETBF2-41	M12x1 Concave Seat For -4 Hose (CT)
HETBF2-41X	M12x1 Convex Seat For -4 Hose (CT)
HETBF2-42-3	M12x1.25 Concave Seat For -3 Hose (CT)
BNS5/8W	5/8Whitx26TPI Bulkhead Nut

### MOCAL Aluminium

Part No	
HETBFA2-31	M10x1 Concave Seat For -3 Hose (CT)
HETBFAC2-31V	M10x1 Concave Seat For -3 Hose (C)

## MOCAL Standard Banjo Fitting



Direct fitting into callipers, wheel & brake cylinders. Takes long banjo bolts, see page 61, & page 70 for washers.

### MOCAL Plated Steel

Part No	
HETBAN-3	Takes 3/8in / M10 / 1/8BSP Bolt For -3 Hose
HETBAN-4-3	Takes 7/16in Bolt For -3 Hose
HETBAN-41-3	Takes M12 Bolt For -3 Hose
HETBAN-3-4	Takes 3/8in / M10 / 1/8BSP Bolt For -4 Hose
HETBAN-4	Takes 7/16in Bolt For -4 Hose
HETBAN-M12-4	Takes M12 Bolt For -4 Hose

### MOCAL Aluminium

Part No	
HETBANA-3	Takes 3/8in / M10 / 1/8BSP Bolt For -3 Hose
HETBANA-3-4	Takes 3/8in / M10 / 1/8BSP Bolt For -4 Hose
HETBANA-4	Takes 7/16in / M12 Bolt For -4 Hose

### MOCAL Stainless Steel

Part No	
HETBANSS-3	Takes 3/8in / M10 / 1/8BSP Bolt For -3 Hose
HETBANSS-3-4	Takes 3/8in / M10 / 1/8BSP Bolt For -4 Hose
HETBANSS-4-3	Takes 7/16in Bolt For -3 Hose
HETBANSS-4-4	Takes 7/16in Bolt For -4 Hose

## MOCAL Twin Take Off Standard Banjo Fittings



### MOCAL Plated Steel

Part No	
HETBAN3-3	Takes 3/8in / M10 / 1/8BSP Bolt For -3 Hoses

### MOCAL Aluminium

Part No	
HETBANA3-3	As Above But Extended

## MOCAL Extended Neck Banjo Fitting



Has slimmer profile than standard banjo. Direct fitting into callipers, wheel & brake cylinders. Takes short banjo bolts, see page 61 & page 70 for washers.

### MOCAL Plated Steel

Part No	
HETBAN1-3	Straight Takes 3/8in / M10/1/8BSP Bolt For -3 Hose
HETBAN1-4-3	Straight Takes 7/16in Bolt For -3 Hose
HETBAN1-4	Straight Takes 7/16in Bolt For -4 Hose
HETBAN1-3-4	Straight Takes 3/8in / M10 / 1/8BSP Bolt For -4 Hose

### MOCAL Aluminium

Part No	
HETBANA1-3	Straight Takes 3/8in / M10 / 1/8BSP Bolt For -3 Hose

### MOCAL Stainless Steel

Part No	
HETBANSS1-3	Straight Takes 3/8in / M10 / 1/8BSP Bolt For -3 Hose

## MOCAL Extended Neck Banjo With Bend



Has slimmer profile than standard banjo. Direct fitting into callipers, wheel & brake cylinders. Takes short banjo bolts, see page 61 & page 70 for washers.

### MOCAL Plated Steel

Part No	
HETBAN2-3	20° Bend Takes 3/8in / M10 / 1/8BSP Bolt For -3 Hose
HETBAN20-3	20° Side Bend 3/8in / M10 / 1/8BSP Bolt For -3 Hose
HETBAN4-3	45° Bend Takes 3/8in / M10 / 1/8BSP Bolt For -3 Hose
HETBAN7-3	70° Bend Takes 3/8in / M10 / 1/8BSP Bolt For -3 Hose
HETBAN9-3	90° Bend Takes 3/8in / M10 / 1/8BSP Bolt For -3 Hose

### MOCAL Aluminium

Part No	
HETBANA2-3	20° Bend Takes 3/8in / M10 / 1/8BSP Bolt For -3 Hose
HETBANA20-3	20° Side Bend 3/8in / M10 / 1/8BSP Bolt For -3 Hose
HETBANA2-4-3	20° Takes 7/16in Bolt For -3 Hose
HETBANA2-3-4	20° Takes 3/8in / M10 / 1/8BSP Bolt For -4 Hose
HETBANA2-4	20° Takes 7/16in Bolt For -4 Hose
HETBANA4-3	45° Takes 3/8in / M10 / 1/8BSP Bolt For -3 Hose
HETBANA7-3	70° Takes 3/8in / M10 / 1/8BSP Bolt For -3 Hose
HETBANA9-3	90° Takes 3/8in / M10 / 1/8BSP Bolt For -3 Hose

### MOCAL Stainless Steel

Part No	
HETBANSS2-3	20° Bend Takes 3/8in / M10 / 1/8BSP Bolt For -3 Hose
HETBANSS4-3	20° Side Bend 3/8in / M10 / 1/8BSP Bolt For -3 Hose
HETBANSS5-3	45° Bend Takes 3/8in / M10 / 1/8BSP Bolt For -3 Hose
HETBANSS7-3	70° Bend Takes 3/8in / M10 / 1/8BSP Bolt For -3 Hose
HETBANSS9-3	90° Bend Takes 3/8in / M10 / 1/8BSP Bolt For -3 Hose

## MOCAL Extended Neck Twin Take Off Banjo



Has slimmer profile than standard banjo. Direct fitting into callipers, wheel & brake cylinders. Takes short banjo bolts, see page 60 & page 70 for washers.

### MOCAL Plated Steel

Part No	
HETBAN6-3	Takes 3/8in / M10 / 1/8BSP Bolt For -3 Hose

### MOCAL Aluminium

Part No	
HETBANA13-3	Takes 3/8in / M10 / 1/8BSP Bolt For -3 Hose

### MOCAL Stainless Steel

Part No	
HETBANSS6-3	Takes 3/8in / M10 / 1/8BSP Bolt For -3 Hose

## MOCAL Hose End Banjo Bolt



### MOCAL Plated Steel

Part No	
HETBBS2-31	M10x1 Short
HETBBSL2-31	M10x1 Long

## MOCAL Hose End Male Tee



### MOCAL Stainless Steel

Part No	
HETT-3	Takes -3 Hose With 5mm Fixing Hole

## MOCAL Hose End Male/Female Tee



Harley Davidson brake light adapters for -3TFE, tapped 1/8NPTF also useful for plumbing oil pressure warning light switch into pressure gauge lines.

### MOCAL Stainless Steel

Part No	
HAR3	Takes -3 Hose - Tapped 1/8NPTF

## Power Steering Fittings For TFE Hose



Male fittings, swivel, 45° concave seat.

Part No	
FBM1137	1/2UNF Straight For -6 Hose
FBM1138	5/8UNF Straight For -6 Hose
FBM1155	1/2UNF 45° For -6 Hose
FBM1141	5/8UNF 45° For -6 Hose
FBM1143	1/2UNF 90° For -6 Hose
FBM1144	5/8UNF 90° For -6 Hose

## Aeroquip Sleeves For TFE



Supplied with all hose end fittings but available separately. **MOCAL** parts which are cheaper also available, please enquire.

<i>Aeroquip Brass</i>	
Part No	
FBM3720	For -3 Fittings
FBM3721	For -4 Fittings
900568-6	(FBM3823) For -6 Fittings
900568-8	(FBM3824) For -8 Fittings
<i>Aeroquip Stainless Steel</i>	
Part No	
FBM3821	For -3 Fittings
FBM3822	For -4 Fittings
900767-4C	For -4 Fitting In 666-4 Hose

## Aeroquip Sockets For TFE



Supplied with all hose end fittings but available separately. **MOCAL** parts which are cheaper also available, please enquire.

<i>Aeroquip Gold Finish</i>	
Part No	
1206-3	For 1/8BSP Fittings
1206-4	For 1/4BSP Fittings
<i>Aeroquip Stainless Steel</i>	
Part No	
FBM3820	For -3JIC Fittings
F506-4C	For -4JIC Fittings

## Stainless Braided TFE Brake Hose



Brake hoses are made from TFE stainless steel wire braided hose with stainless steel fittings. Titanium fittings are also available, please enquire Application: Intended for use on competition vehicles to provide a hard feel and reduced travel to the brake pedal, this is achieved due to the lower volume of expansion under pressure achievable in this construction. They are also lighter than conventional hoses and more resistant to stone damage. They are not built to conform to existing standards laid down for brake hoses in normal use due to their inability to resist the continuous flexing that might occur in a vehicle with large wheel travel covering hundreds of thousands of miles between hose changes. Care must be taken in fitting to ensure that the hoses do not contact any moving part under conditions of extreme suspension travel and/or full steering lock. We do not offer any guarantee of their suitability for any purpose outside usage on off road vehicles under conditions of regular inspection. No responsibility can be taken for any damage, injury or loss resulting from their use. We can make up competition brake hose assemblies for any car or motorbike. Hoses are made with our Stainless Steel fittings swaged to clear PVC covered s/s braided TFE hose.

Part No.	
<i>Break Hose kits</i>	
BHKALF-4-040	ALFA ROMEO 147 3.2 GTA
BHKALF-4-073	ALFA ROMEO 156 3.2 GTA
BHKAUD-4-361	AUDI A1 ALL VARIANTS
BHKAUD-4-145	AUDI A3 QUATTRO 3.2 S LINE
BHKAUD-4-352	AUDI R8 2007-
BHKBMW-4-262	BMW 3 SERIES E46 M3
BHKBMW-4-045	BMW MINI COOPER R56 COOPER S
BHKBMW-6-619	BMW Z3 2.8 1997-2000
BHKCIT-4-030	CITROEN C1 1.0
BHKFIA-6-501	FIAT ABARTH 500/595/695
BHKFOR-4-217	FORD FIESTA ST150 2.0
BHKFOR-4-501	FORD FIESTA ST180 1.6 ECOBOOST
BHKFOR-6-478	FORD FOCUS MK1 TURBO RS
BHKFOR-4-479	FORD FOCUS MK2 RS
BHKFOR-4-480	FORD FOCUS MK2 ST
BHKHON-4-057	HONDA CIVIC EP3 2.0 TYPE R 2001-2005
BHKHON-4-737	HONDA CIVIC FK8 TYPE R 2017-
BHKHON-4-129	HONDA S2000 1999-
BHKJAG-4-010	JAGUAR E-TYPE SERIES 3 V12 5.3
BHKLAM-4-004	LAMBORGHINI GALLARDO
BHKMAZ-4-096	MAZDA MX-5 1.6 1990-2005
BHKMAZ-4-098	MAZDA MX-5 1.8 1994-2005
BHKPEU-4-019	PEUGEOT 106 1.6 GTI
BHKPOR-4-204	PORSCHE 911 (997) 2004-2012
BHKREN-4-112	RENAULT CLIO 172 2000-2001
BHKREN-4-113	RENAULT CLIO 182
BHKREN-4-115	RENAULT CLIO 197 2006-2009
BHKREN-4-243	RENAULT MEGANE 2.0 RS 225
BHKSEA-4-125	SEAT LEON MK1 CUPRA R BREMBO
BHKSUB-4-011	SUBARU IMPREZA 2.0 WRX/STI 1992-2000
BHKSUB-4-051	SUBARU IMPREZA 2.5 WRX/STI 2017-
<i>Clutch kits</i>	
CHCCK095	BMW MINI R55-R61 2005-
CHCCK071	FORD FOCUS ALL ENGINES 1998-2007
CHCCK143	HONDA CIVIC FK2, FK8 TYPE R 2015-
CHCCK013	NISSAN 200SX S14
CHCCK125	RENAULT MEGANE II RS 250, 265 2012-
CHCCK057	VW GOLF MK2 1.8 G60

## Swaged Fittings For **MOCAL** TFE Hoses

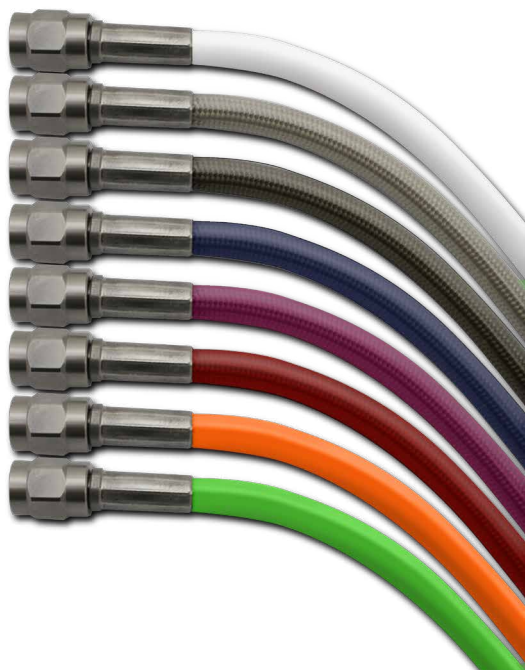

We have introduced a range of stainless steel fittings suitable for factory swaging. These are a neater and lighter alternative to the reusable fittings. We use them when supplying complete kits and are also available as single hose assemblies where exact lengths can be specified. Do your own swaging? Enquire within.

### Swaged Female Straight Swivel Fittings



Part No	
FERSS-03	Stainless Steel Ferrule For Swageing
1 Ferrule Is Required For Each Fitting.	
H650-03C-CCV	Straight Concave 3/8inx24TPI For -3 Hose
H650-31C-CCV	Straight Concave M10x1 For -3 Hose
H650-32C-CCV	Straight Concave M10x1.25 For -3 Hose
H650-03C-CVX	Straight Convex 3/8inx24TPI For -3 Hose
H650-31C-CVX	Straight Convex M10x1 For -3 Hose
H650-32C-CVX	Straight Convex M10x1.25 For -3 Hose
H650-18C-CVX	Straight Convex 1/8in BSP For -3 Hose
H650-04	Straight Concave For 7/16inx20TPI For -4 Hose

### Swaged Female 45° Swept Tube Swivel Fittings



Part No	
H653-03C-CCV	Concave 3/8Inx24TPI For -3 Hose
H653-31C-CCV	Concave M10x1 For -3 Hose
H653-32C-CCV	Concave M10x1.25 For -3 Hose
H653-04C-CCV	Concave 7/16inx20TPI For -4 Hose
H653-03C-CVX	Convex 3/8inx24TPI For -3 Hose
H653-31C-CVX	Convex M10x1 For -3 Hose
H653-32C-CVX	Convex M10x1.25 For -3 Hose

## Swaged Female 90° Swept Tube Swivel Fittings



Part No	
H654-03C-CCV	Concave 3/8inx24TPI For -3 Hose
H654-31C-CCV	Concave M10x1 For -3 Hose
H654-32C-CCV	Concave M10x1.25 For -3 Hose
H654-03C-CVX	Convex 3/8inx24TPI For -3 Hose
H654-31C-CVX	Convex M10x1.00 For -3 Hose
H654-32C-CVX	Convex M10x1.25 For -3 Hose
H654-04C-CCV	Concave 7/16inx20TPI For -4 Hose

### Swaged Male Straight Swivel Fittings



Direct fitting into callipers, master and wheel cylinders. Convex & concave seal on bottom of port.

Part No	
H652-18C-CVX	Convex 1/8BSP, For -3 Hose
H652-03C-CVX	Convex 3/8inx24TPI For -3 Hose
H652-31C-CVX	Convex M10x1 For -3 Hose
H652-32C-CVX	Convex M10x1.25 For -3 Hose
H652-18C-CCV	Concave 1/8BSP, For -3 Hose
H652-03C-CCV	Concave 3/8inx24TPI For -3 Hose
H652-31C-CCV	Concave M10x1 For -3 Hose
H652-32C-CCV	Concave M10x1.25 For -3 Hose

### Swaged Male Straight Fixed Fittings



Non swivel, direct fitting into callipers, master and wheel cylinders. Convex & concave seal on bottom of port.

Part No	
H657-03C	Convex 3/8inx24TPI For -3 Hose
H657-31C	Convex M10x1 For -3 Hose
H657-32C	Convex M10x1.25 For -3 Hose
H658-03C	Concave 3/8inx24TPI For -3 Hose
H658-31C	Concave M10x1 For -3 Hose
H658-32C	Concave M10x1.25 For -3 Hose

### Swaged Male 45° Male Swivel Fittings



Part No	
H673-18C-CCV	Concave 1/8BSP For -3 Hose
H673-03C-CCV	Concave 3/8inx24TPI For -3 Hose
H673-31C-CCV	Concave M10x1 For -3 Hose
H673-32C-CCV	Concave M10x1.25 For -3 Hose
H683-18C-CVX	Convex 1/8BSP For -3 Hose
H683-03C-CVX	Convex 3/8inx24TPI For -3 Hose
H683-31C-CVX	Convex M10x1 For -3 Hose
H683-32C-CVX	Convex M10x1.25 For -3 Hose



## Swaged Male 90° Swivel Fittings



### Part No

H674-18C-CCV	Concave 1/8in X 18BSP, For -3 Hose
H674-03C-CCV	Concave 3/8in X 24JIC, For -3 Hose
H674-31C-CCV	Concave M10 X 1.00, For -3 Hose
H674-32C-CCV	Concave M10 X 1.25, For -3 Hose
H684-18C-CVX	Convex 1/8in X 18BSP, For -3 Hose
H684-03C-CVX	Convex 3/8in X 24JIC, For -3 Hose
H684-31C-CVX	Convex M10 X 1.00, For -3 Hose
H684-32C-CVX	Convex M10 X 1.25, For -3 Hose

## Swaged Male Bulkhead Fixed Fittings



Non swivel, direct fitting into callipers, master and wheel cylinders. Convex & concave seal on bottom of port.

### Part No

H659-03C	Bulkhead 3/8inx24TPI For -3 Hose
H669-31C	Bulkhead M10x1 For -3 Hose
H669-32C	Bulkhead M10x1.25 For -3 Hose

## Swaged Male Bulkhead Fixed Fittings With Bend



### Part No

H659-03CL	Bulkhead 3/8inx24TPI For -3 Hose
H669-31CL	Bulkhead M10x1.00 For -3 Hose

## Swaged Female Bulkhead Fittings



Non swivel, Threaded takes M16x2.0 nut. Circlip uses original snap clip. Direct fitting onto metal brake pipes with male nuts.

### Part No

H660-31C	Fixed, M10x1 For -3 Hose
H663-03C	Circlip, Concave 3/8inx24TPI For -3 Hose
H663-31C	Circlip, Concave M10x1 For -3 Hose
H663-32C	Circlip, Concave M10x1.25 For -3 Hose
H664-03C	Circlip, Convex 3/8inx24TPI For -3 Hose
H664-31C	Circlip, Convex M10x1.00 For -3 Hose
H664-32C	Circlip, Convex M10x1.25 For -3 Hose
H665-03C	External Thread, Concave 3/8inx24TPI For -3 Hose
H665-31C	External Thread, Concave M10x1 For -3 Hose
H665-32C	External Thread, Concave M10x1.25 For -3 Hose
H666-03C	External Thread, Convex 3/8inx24TPI For -3 Hose
H666-31C	External Thread, Convex M10x1 For -3 Hose
H666-32C	External Thread, Convex M10x1.25 For -3 Hose

## Swaged Standard Banjo Fitting



Direct fitting into callipers, wheel & brake cylinders. Takes short banjo bolts, see page 61 & page 70 for washers.

### Part No

H692-03C	Straight Banjo 10mm Hole For -3 Hose
H692-03-08C	Straight Banjo 8mm Hole For -3 Hose
H692-03-11C	Straight Banjo 11mm Hole For -3 Hose
H692-03-12C	Straight Banjo 12mm Hole For -3 Hose
H692-04C	Straight Banjo 10mm Hole For -4 Hose

## Swaged Banjo Fitting With Bend



Direct fitting into callipers, wheel & brake cylinders. Takes short banjo bolts, see page 61 & page 70 for washers.

### Part No

H693-03C	20° Banjo 10mm Hole For -3 Hose
H695-03C	20° Side Bend Banjo 10mm Hole For -3 Hose
H694-03C	45° Banjo 10mm Hole For -3 Hose
H697-03C	70° Banjo 10mm Hole For -3 Hose
H699-03C	90° Banjo 10mm Hole For -3 Hose

## Swaged Twin Take Off Banjo Fittings



Direct fitting into callipers, wheel & brake cylinders. Takes short banjo bolts, see page 61 & page 70 for washers.

### Part No

H698-03C	Double Exit Banjo 10mm Hole For -3 Hose
----------	---

## Swaged Hose End Tee



### Part No

MTSS-03	Tee Piece For -3 Hose
---------	-----------------------

## Quick Release Clutch Hose End



### Part No

HCF-1	BMW Mini Clutch Fitting -3 SS SWG
HCF-2	MK1 Focus RS Clutch Fitting -3 SS

## Special purpose Hoses

### BS Au108 Fuel Hose

An inexpensive hose with single textile braid reinforcement and smooth black neoprene cover complies with British standard BS Au108/2-L4/C4/R for fuel hose.

Part No	I.D. inch/mm	O.D. inch/mm	Working Pressure
SPH1 - 4	1/4"/6.3mm	0.50"/12.7mm	150psi
SPH1 - 5	5/16"/7.9mm	0.58"/14.7mm	150psi
SPH1 - 6	3/8"/9.5mm	0.66"/16.7mm	150psi

Part No.	I.D. inch/mm	O.D. inch/mm	Working Pressure
SPH2 - 4	1/4"/6.3mm	0.51"/13mm	150psi
SPH2 - 5	5/16"/7.9mm	0.60"/15.3mm	150psi
SPH2 - 6	3/8"/9.5mm	0.68"/17.3mm	150psi

Part No	
SPH1-4	1/4in ID
SPH1-5	5/16in ID
SPH1-6	3/8in ID
As Above But With Stainless Steel Cover	
SPH2-4	1/4in ID With Stainless Cover
SPH2-5	5/16in ID With Stainless Cover
SPH2-6	3/8in ID With Stainless Cover

### Stainless Steel Braided Fuel Hose

Stainless steel braided hose, suitable for commercial fuels and fuel mixtures up to a maximum of 50% Benzol. Hose is suitable for E10. It is less bulky than the BS Au108 compliant hose above.

Part No.	I.D. inch/mm	O.D. inch/mm	Working Pressure
SPH3 - 4	1/4"/6.3mm	0.45"/11.43mm	100psi
SPH3 - 5	5/16"/7.9mm	0.49"/12.45mm	100psi
SPH3 - 6	3/8"/9.5mm	0.56"/14.22mm	100psi

Part No	
SPH3-4	1/4in ID, Thin Wall With Stainless Cover
SPH3-5	5/16in ID, Thin Wall With Stainless Cover
SPH3-6	3/8in ID, Thin Wall With Stainless Cover

### Brake Fluid Resistant Hose

Use for gravity feed to master cylinder from remote reservoir. Special rubber liner with black outer cover.

Part No	I.D. inch/mm	O.D. inch/mm	Burst Pressure
SPH8 - 4	9/32"/7mm	0.53"/13.46mm	nil
SPH8 - 5	5/16"/8mm	0.56"/14.22mm	nil
SPH8 - 6	3/8"/9.53mm	0.63"/16.00mm	nil

Part No	
SPH8-4	7mm ID Brake Fluid Hose
SPH8-5	8mm ID Brake Fluid Hose
SPH8-6	3/8in ID Brake Fluid Hose

## Vacuum Servo Hose

Black nitrile outer and inner, reinforced textile hose for brake servos.

Part No	
VH-3	3/16in ID - 7/16in OD
VH-6	3/8in ID - 11/16in OD

## Silicone Vacuum Hose

Thick walled non reinforced silicone hose for use in all applications except brakes. Blue as standard, add suffix R for red or B for black.

Part No	
VH-M3	3mm ID
VH-M4	4mm ID
VH-M5	5mm ID
VH-M6	6mm ID
VH-M8	8mm ID
VH-M10	10mm ID

## T Pieces



Assemble with swage ferrule, O clamp or worm drive clamp. Suitable for low pressure systems e.g. carburettor feeds, breathers.

Brass	
Part No	
MTB14-3	3/16in Push On
MTB14-4	1/4in Push On
MTB14-5	5/16in Push On
MTB14-6	3/8in Push On
MTB14-8	1/2in Push On

Steel	
Part No	
MTS14-3	3/16in Push On
MTS14-4	1/4in Push On
MTS14-5	5/16in Push On
MTS14-6	3/8in Push On
MTS14-8	1/2in Push On

Unequal	
Part No	
MTS14-5-3-5	2x5/16in & 1x3/16in
MTS14-6-5-6	2x3/8in & 1x5/16in

## Y Pieces



Assemble with swage ferrule, O clamp or worm drive clamp. Suitable for low pressure systems e.g. carburettor feeds, breathers, water.

Part No	
MYB14-4	1/4in Push On - Brass
MYB14-5	5/16in Push On - Brass
MYB14-6	3/8in Push On - Brass
MYB14-8	1/2in Push On - Brass

## Hose Joiners



Assemble with swage ferrule, O clamp or worm drive clamp. Suitable for low pressure systems e.g. carburettor feeds, breathers, water. Larger aluminium joiners use with silicone hose (next page).

### Steel

Part No	
HM-4	For 1/4in ID Hose
HM-5	For 5/16in ID Hose
HM-6	For 3/8in ID Hose
HM-8	For 1/2in ID Hose
HM-10	For 5/8in ID Hose
HM-12	For 3/4in ID Hose
HM-4-5	Step Up 1/4in To 5/16in ID Hose
HM-5-6	Step Up 5/16in To 3/8in ID Hose
HM-5-8	Step Up 5/16in To 1/2in ID Hose
HM-6-8	Step Up 3/8in To 1/2in ID Hose
HM-8-10	Step Up 1/2in To 5/8in ID Hose

### Billet Aluminium

Part No	
HJ-M13	13mm Tube 2.5in Long
HJ-M16	16mm Tube 2.5in Long
HJ-M19	19mm Tube 2.5in Long
HJ-M22	22mm Tube 2.5in Long
HJ-M25	25mm Tube 2.5in Long
HJ-M28	28mm Tube 2.5in Long
HJ-M32	32mm Tube 2.5in Long
HJ-M35	35mm Tube 2.5in Long
HJ-M38	38mm Tube 2.5in Long
HJ-M41	41mm Tube 2.5in Long
HJ-M45	45mm Tube 2.5in Long
HJ-M48	48mm Tube 2.5in Long
HJ-M51	51mm Tube 2.5in Long
HJ-M54	54mm Tube 2.5in Long
HJ-M57	57mm Tube 2.5in Long
HJ-M60	60mm Tube 2.5in Long
HJ-M63	63mm Tube 2.5in Long
HJ-M65	65mm Tube 2.5in Long
HJ-M70	70mm Tube 2.5in Long
HJ-M76	76mm Tube 2.5in Long

## Bleed Nipples

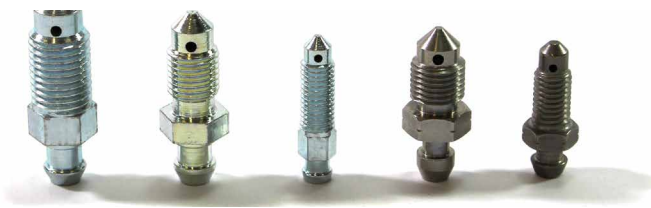

### Plated Steel

Part No	
NIP1-1/4	Bleed Nipple 1/4x28UNF For 3/8in Tube
NIP1-3	Bleed Nipple 3/8x24UNF For 3/8in Tube
NIP5-11	Bleed Nipple M7x1 For 1/4in Tube
NIP5-22	Bleed Nipple M8x1.25 For 1/4in Tube
NIP5-31	Bleed Nipple M10x1 For 3/8in Tube

### Stainless Steel

Part No	
NIP1-3SS	Bleed Nipple 3/8x24UNF For 3/8in Tube
NIP1-3SS	Bleed Nipple 3/8x24UNF For 3/8in Tube Long
NIP5-11SS	Bleed Nipple M7x1.00 For 1/4in Tube
NIP5-22SS	Bleed Nipple M8x1.25 For 1/4in Tube
NIP5-31SS	Bleed Nipple M10x1.00 For 3/8in Tube
NIP2-32SB	Bleed Nipple M10x1.25

## Silicone Rubber Coolant Hoses

Blue, red or black silicone rubber with smooth wipe down finish. Temperature range -50°C to 250°C. Specials available to order include longer legs, reducing straights and elbows, wire reinforcing. Use for engine coolant hoses, turbo charger and supercharger hoses, heating and ventilating ducts where increased hose life and resistance to high under bonnet temperatures are required. Compatible with hose joiners on previous page. Part Numbers are for blue hose, add R for red or B for black. Please ask for sizes.

### Straight Hose



Available colours ■ ■ ■

#### Straight 1 Metre Lengths

Part No	
SH-M6.5	Hose - ID 6.5mm
SH-M8	Hose - ID 8.0mm
SH-M9.5	Hose - ID 9.5mm
SH-M11	Hose - ID 11mm
SH-M13	Hose - ID 13mm
SH-M16	Hose - ID 16mm
SH-M19	Hose - ID 19mm
SH-M22	Hose - ID 22mm
SH-M25	Hose - ID 25mm
SH-M28	Hose - ID 28mm
SH-M32	Hose - ID 32mm
SH-M35	Hose - ID 35mm
SH-M38	Hose - ID 38mm
SH-M41	Hose - ID 41mm
SH-M45	Hose - ID 45mm
SH-M48	Hose - ID 48mm
SH-M51	Hose - ID 51mm
SH-M54	Hose - ID 54mm
SH-M57	Hose - ID 57mm
SH-M60	Hose - ID 60mm
SH-M63	Hose - ID 63mm
SH-M70	Hose - ID 70mm
SH-M76	Hose - ID 76mm
SH-M80	Hose - ID 80mm
SH-M83	Hose - ID 83mm
SH-M89	Hose - ID 89mm
SH-M102	Hose - ID 102mm

### 30° Hose



Available colours ■ ■ ■

#### 30° With 102mm Legs Unless Otherwise Stated

Part No	
SH30-M6.5	Hose - ID 6.5mm
SH30-M8	Hose - ID 8.0mm
SH30-M9.5	Hose - ID 9.5mm
SH30-M11	Hose - ID 11mm
SH30-M13	Hose - ID 13mm
SH30-M16	Hose - ID 16mm
SH30-M19	Hose - ID 19mm
SH30-M22	Hose - ID 22mm
SH30-M25	Hose - ID 25mm
SH30-M28	Hose - ID 28mm
SH30-M30	Hose - ID 30mm
SH30-M32	Hose - ID 32mm
SH30-M35	Hose - ID 35mm
SH30-M38	Hose - ID 38mm
SH30-M41	Hose - ID 41mm
SH30-M45	Hose - ID 45mm
SH30-M48	Hose - ID 48mm
SH30-M51	Hose - ID 51mm
SH30-M54	Hose - ID 54mm
SH30-M57	Hose - ID 57mm
SH30-M60	Hose - ID 60mm 125mm Legs
SH30-M63	Hose - ID 63mm 125mm Legs
SH30-M70	Hose - ID 70mm 125mm Legs
SH30-M76	Hose - ID 76mm 152mm Legs
SH30-M80	Hose - ID 80mm 152mm Legs
SH30-M83	Hose - ID 83mm 152mm Legs
SH30-M89	Hose - ID 89mm 152mm Legs
SH30-M102	Hose - ID 102mm 152mm Legs

## 45° Hose



Available colours ■ ■ ■

### 45° With 102mm Legs Unless Otherwise Stated

Part No	
SH45-M6.5	Hose - ID 6.5mm
SH45-M8	Hose - ID 8.0mm
SH45-M9.5	Hose - ID 9.5mm
SH45-M11	Hose - ID 11mm
SH45-M13	Hose - ID 13mm
SH45-M16	Hose - ID 16mm
SH45-M19	Hose - ID 19mm
SH45-M22	Hose - ID 22mm
SH45-M25	Hose - ID 25mm
SH45-M28	Hose - ID 28mm
SH45-M32	Hose - ID 32mm
SH45-M35	Hose - ID 35mm
SH45-M38	Hose - ID 38mm
SH45-M41	Hose - ID 41mm
SH45-M45	Hose - ID 45mm
SH45-M48	Hose - ID 48mm
SH45-M51	Hose - ID 51mm
SH45-M54	Hose - ID 54mm
SH45-M57	Hose - ID 57mm
SH45-M60	Hose - ID 60mm 125mm Legs
SH45-M63	Hose - ID 63mm 125mm Legs
SH45-M70	Hose - ID 70mm 125mm Legs
SH45-M76	Hose - ID 76mm 152mm Legs
SH45-M80	Hose - ID 80mm 152mm Legs
SH45-M83	Hose - ID 83mm 152mm Legs
SH45-M89	Hose - ID 89mm 152mm Legs
SH45-M102	Hose - ID 102mm 152mm Legs

## 60° Hose



Available colours ■ ■ ■

### 60° With 102mm Legs Unless Otherwise Stated

Part No	
SH60-M6.5	Hose - ID 6.5mm
SH60-M8	Hose - ID 8.0mm
SH60-M9.5	Hose - ID 9.5mm
SH60-M11	Hose - ID 11mm
SH60-M13	Hose - ID 13mm
SH60-M16	Hose - ID 16mm
SH60-M19	Hose - ID 19mm
SH60-M22	Hose - ID 22mm
SH60-M25	Hose - ID 25mm
SH60-M28	Hose - ID 28mm
SH60-M30	Hose - ID 30mm
SH60-M32	Hose - ID 32mm
SH60-M35	Hose - ID 35mm
SH60-M38	Hose - ID 38mm
SH60-M41	Hose - ID 41mm
SH60-M45	Hose - ID 45mm
SH60-M48	Hose - ID 48mm
SH60-M51	Hose - ID 51mm
SH60-M54	Hose - ID 54mm
SH60-M57	Hose - ID 57mm
SH60-M60	Hose - ID 60mm 125mm Legs
SH60-M63	Hose - ID 63mm 125mm Legs
SH60-M70	Hose - ID 70mm 125mm Legs
SH60-M76	Hose - ID 76mm 152mm Legs
SH60-M80	Hose - ID 80mm 152mm Legs

## 90° Hose



Available colours ■ ■ ■

### 90° With 102mm Legs Unless Otherwise Stated

Part No	
SH90-M6.5	Hose - ID 6.5mm
SH90-M8	Hose - ID 8.0mm
SH90-M9.5	Hose - ID 9.5mm
SH90-M11	Hose - ID 11mm
SH90-M13	Hose - ID 13mm
SH90-M14	Hose - ID 14mm
SH90-M16	Hose - ID 16mm
SH90-M18	Hose - ID 18mm
SH90-M19	Hose - ID 19mm
SH90-M20	Hose - ID 20mm
SH90-M22	Hose - ID 22mm
SH90-M25	Hose - ID 25mm
SH90-M28	Hose - ID 28mm
SH90-M30	Hose - ID 30mm
SH90-M32	Hose - ID 32mm
SH90-M35	Hose - ID 35mm
SH90-M38	Hose - ID 38mm
SH90-M41	Hose - ID 41mm
SH90-M45	Hose - ID 45mm
SH90-M48	Hose - ID 48mm
SH90-M51	Hose - ID 51mm
SH90-M54	Hose - ID 54mm
SH90-M57	Hose - ID 57mm
SH90-M60	Hose - ID 60mm 125mm Legs
SH90-M63	Hose - ID 63mm 125mm Legs
SH90-M65	Hose - ID 65mm 125mm Legs
SH90-M70	Hose - ID 70mm 125mm Legs
SH90-M76	Hose - ID 76mm 152mm Legs
SH90-M80	Hose - ID 80mm 152mm Legs
SH90-M83	Hose - ID 83mm 152mm Legs
SH90-M89	Hose - ID 89mm 152mm Legs
SH90-M102	Hose - ID 102mm 152mm Legs

## 135° Hose



Available colours ■ ■ ■

### 135° With 102mm Legs Unless Otherwise Stated

Part No	
SH135-M6.5	Hose - ID 6.5mm
SH135-M8	Hose - ID 8mm
SH135-M9.5	Hose - ID 9.5mm
SH135-M11	Hose - ID 11mm
SH135-M13	Hose - ID 13mm
SH135-M16	Hose - ID 16mm
SH135-M19	Hose - ID 19mm
SH135-M22	Hose - ID 22mm
SH135-M25	Hose - ID 25mm
SH135-M28	Hose - ID 28mm
SH135-M32	Hose - ID 32mm
SH135-M35	Hose - ID 35mm
SH135-M38	Hose - ID 38mm
SH135-M41	Hose - ID 41mm
SH135-M45	Hose - ID 45mm
SH135-M48	Hose - ID 48mm
SH135-M51	Hose - ID 51mm
SH135-M54	Hose - ID 54mm
SH135-M57	Hose - ID 57mm
SH135-M60	Hose - ID 60mm 125mm Legs
SH135-M63	Hose - ID 63mm 125mm Legs
SH135-M70	Hose - ID 70mm 125mm Legs
SH135-M76	Hose - ID 76mm 152mm Legs
SH135-M80	Hose - ID 80mm 152mm Legs

## 180° Hose



Available colours ■ ■ ■

### 180° With 102mm Legs Unless Otherwise Stated

Part No	Hose - ID	Legs
SH180-M16	16mm	
SH180-M19	19mm	
SH180-M22	22mm	
SH180-M25	25mm	
SH180-M28	28mm	
SH180-M32	32mm	
SH180-M35	35mm	
SH180-M38	38mm	
SH180-M41	41mm	
SH180-M45	45mm	
SH180-M48	48mm	
SH180-M51	51mm	
SH180-M54	54mm	
SH180-M57	57mm	
SH180-M60	60mm	125mm
SH180-M63	63mm	125mm
SH180-M76	76mm	152mm

## Straight & 90° Reducers



Available colours ■ ■ ■

### Straight Reducers With 102mm Length

SHR-M19-M16	Straight Reducer M19 -M16 Hose ID
SHR-M22-M16	Straight Reducer M22 -M16 Hose ID
SHR-M25-M19	Straight Reducer M25 -M19 Hose ID
SHR-M32-M25	Straight Reducer M32 -M25 Hose ID
SHR-M38-M32	Straight Reducer M38 -M32 Hose ID
SHR-M45-M38	Straight Reducer M45 -M38 Hose ID
SHR-M54-M51	Straight Reducer M54 -M51 Hose ID
SHR-M57-M51	Straight Reducer M57 -M51 Hose ID
SHR-M70-M50	Straight Reducer M70 -M50 Hose ID
SHR-M76-M51	Straight Reducer M76 -M51 Hose ID
SHR-M102-M76	Straight Reducer M102 -M76 Hose ID

### 90° Reducers With 102mm - 125mm Legs

Part No	Reducer
SH90R-M16-M13	90° Reducer M16 - M13
SH90R-M25-M19	90° Reducer M25 - M19
SH90R-M35-M32	90° Reducer M35 - M32
SH90R-M38-M32	90° Reducer M38 - M32
SH90R-M38-M35	90° Reducer M38 - M35
SH90R-M45-M25	90° Reducer M45 - M25
SH90R-M57-M51	90° Reducer M57 - M51
SH90R-M60-M51	90° Reducer M60 - M51

Please ask for more sizes

This is a small selection of the reducers available.

## Pro-Clamps - Aeroquip



Function: Hose finishers that are used on hose assemblies with push on fittings to hide unsightly ends especially where stainless braid is used.

Construction: Top grade z stainless steel worm drive clamps with red anodised surrounds machined from solid aluminium.

Part No	Hose Size
FBM1001	Up To 0.44in OD Hose
FBM1002	Up To 0.55in OD Hose
FBM1003	Up To 0.65in OD Hose
FBM1004	Up To 0.80in OD Hose
FBM1005	Up To 0.94in OD Hose

## Stainless Steel Overbraid



Function: Designed to slip over existing hoses it will bunch up to 10% and pull down to 50% of its diameter. It is extremely flexible and will form round curved moulded hoses, it can be cut with snips or sharp scissors. We suggest it is used with a Pro-clamp or Mo-clamp to avoid unsightly raw edges.

### Stainless Steel

Part No	Overbraid
OB-5	0.5in ID
OB-75	0.75in ID
OB-1.25	1.25in ID
OB-1.75	1.75in ID
OB-2.25	2.25in ID

## Mo-Clamps, Blue & Red Mo-Clamps



Similar to Pro-clamps not of Aeroquip manufacture. Sizes up to -12 are Hexagonal; large sizes have round bodies. Prices in chrome vary.

Clamps are red by default. Add suffix B for blue, BK for black, C for chrome.

Part No	Mo-Clamp
HF-4	Up To 0.50in OD Hose
HF-6	Up To 0.60in OD Hose
HF-8	Up To 0.69in OD Hose
HF-10	Up To 0.85in OD Hose
HF-12	Up To 0.98in OD Hose
HF-16	Up To 1.20in OD Hose
HF-20	Up To 1.50in OD Hose
HF-21	Up To 1.81in OD Hose
HF-22	Up To 1.94in OD Hose
HF-24	Up To 2.03in OD Hose
HF-26	Up To 2.09in OD Hose
HF-28	Up To 2.31in OD Hose
HF-30	Up To 2.38in OD Hose
HF-32	Up To 2.18in OD Hose
HF-34	Up To 2.31in OD Hose
HF-36	Up To 2.38in OD Hose

## Worm Drive Hose Clamps



Construction: Top quality clamps with worm gear and through slots, hexagon/slotted drive, 1/4 on 8mm width, 5/16 on 13mm. We stock all stainless also stainless band with plated screw & housing. We can supply shielded clamps that have an inner stainless band to stop soft rubber, as in silicone hoses, being extruded through the slots. Application: Use with serrated or beaded tube fittings, if using with fir tree fittings take care not to clamp on sharp edges or hose may be cut through, Tightening torque 10 in/lbs, re-torque when hot.

Part No	
HC1-1	8mm Stainless Band 6-16mm
HC1-2	8mm Stainless Band 8-22mm
HC1-3	8mm Stainless Band 10-27mm
HC2-2	8mm All Stainless 6-16mm
HC2-3	8mm All Stainless 8-22mm
HC2-1	8mm All Stainless 10-25mm
HC2-4	8mm All Stainless 10-27mm
HC2-5	8mm All Stainless 13-32mm
HC2-6	8mm All Stainless 19-44mm
HC2-7	8mm All Stainless 26-51mm
HC2-8	8mm All Stainless 32-57mm
HC2-9	8mm All Stainless 38-63mm
HC3-1	13mm All Stainless 27-51mm
HC3-2	13mm All Stainless 33-57mm
HC3-2.5	13mm All Stainless 40-63mm
HC3-4	13mm All Stainless 45-70mm
HC3-5	13mm All Stainless 63-114mm
HC3-7	13mm All Stainless 78-101mm
HC3-3	13mm All Stainless 115-165mm

## Worm Drive Embossed Band Clamps



A high-quality, rolled-edge stainless clamp with an embossed band, ideal for use with silicone hose as they will not cut into the hose.

Part No	
HC5-1	Wormdrive S/S Clip 8-12mm
HC5-2	Wormdrive S/S Clip 10-16mm
HC5-3	Wormdrive S/S Clip 12-20mm
HC5-4	Wormdrive S/S Clip 16-27mm
HC5-5	Wormdrive S/S Clip 23-35mm
HC5-6	Wormdrive S/S Clip 30-45mm
HC5-7	Wormdrive S/S Clip 32-50mm
HC5-8	Wormdrive S/S Clip 40-60mm
HC5-9	Wormdrive S/S Clip 50-70mm
HC5-10	Wormdrive S/S Clip 60-80mm
HC5-11	Wormdrive S/S Clip 70-90mm
HC5-12	Wormdrive S/S Clip 80-100mm
HC5-13	Wormdrive S/S Clip 90-110mm
HC5-14	Wormdrive S/S Clip 100-120mm
HC5-15	Wormdrive S/S Clip 110-130mm
HC5-16	Wormdrive S/S Clip 120-140mm
HC5-17	Wormdrive S/S Clip 130-150mm
HC5-18	Wormdrive S/S Clip 140-160mm

## Mikalor Clamps



The W2 (pro) clamp from Mikalor is made of 430 marine grade stainless steel band with 8.8 bolt zinc CR3 plated. These wide band T-Bolt clamps are excellent for use with silicon hose, especially for high-pressure applications. W4 also available on request.

Part No	
MIK-63-68	Mikalor Steel Bolt Clamp 63-68mm
MIK-68-73	Mikalor Steel Bolt Clamp 68-73mm
MIK104-112	Mikalor Clamp 104-112mm M8 Bolt
MIK17-19	Mikalor Clamp 17-19mm M6 Bolt
MIK19-21	Mikalor Clamp 19-21mm M6 Bolt
MIK21-23	Mikalor Clamp 21-23mm M6 Bolt
MIK23-25	Mikalor Clamp 23-25mm M6 Bolt
MIK25-27	Mikalor Clamp 25-27mm M6 Bolt
MIK27-29	Mikalor Clamp 27-29mm M6 Bolt
MIK29-31	Mikalor Clamp 29-31mm M7 Bolt
MIK31-34	Mikalor Clamp 31-34mm M7 Bolt
MIK34-37	Mikalor Clamp 34-37mm M7 Bolt
MIK37-40	Mikalor Clamp 37-40mm M7 Bolt
MIK40-43	Mikalor Clamp 40-43mm M7 Bolt
MIK43-47	Mikalor Clamp 43-47mm M7 Bolt
MIK47-51	Mikalor Clamp 47-51mm M7 Bolt
MIK51-55	Mikalor Clamp 51-55mm M7 Bolt
MIK55-59	Mikalor Clamp 55-59mm M7 Bolt
MIK59-63	Mikalor Clamp 59-63mm M7 Bolt
MIK63-68	Mikalor Clamp 63-68mm M7 Bolt
MIK68-73	Mikalor Clamp 68-73mm M8 Bolt
MIK73-79	Mikalor Clamp 73-79mm M8 Bolt
MIK79-85	Mikalor Clamp 79-85mm M8 Bolt
MIK85-91	Mikalor Clamp 85-91mm M8 Bolt
MIK91-97	Mikalor Clamp 91-97mm M8 Bolt
MIK97-104	Mikalor Clamp 97-104mm M8 Bolt

## Oetiker Hose Clamps



Zinc plated mild steel but also available in stainless steel. Strong, safe and neat hose clamp, tighten by squeezing ears, preferably with Oetiker pincers.



Part No	
HC4-00	O-Clamp 5-7mm
HC4-0	O-Clamp 7-9mm
HC4-1	O-Clamp 10.8-13mm For 1/4in Hose
HC4-2	O-Clamp 12.5-15mm For 5/16in & 3/8in Hose
HC4-3	O-Clamp 14-17mm
HC4-4	O-Clamp 16.2-20mm
HC4-5	O-Clamp 18-22mm For 1/2in Hose
HC4-6	O-Clamp 21-25mm For 5/8in Hose
HC4-7	O-Clamp 22.5-27mm
HC4-8	O-Clamp 26.3-31mm For 3/4in Hose
HCP-1	Pincers For O-Clips

## Wiggins Couplings



These connectors are crucial for race teams that require speedy engine and transmission changes. Max pressure 125psi, burst pressure 375psi. Max temp. 232°C. Ferrules and sleeves available.

Part No	Wiggins	Tube Connector
W991-08DE	Wiggins	0.5in Tube Connector
W991-10DE	Wiggins	0.625in Tube Connector
W991-12DE	Wiggins	0.75in Tube Connector
W991-16DE	Wiggins	1in Tube Connector
W991-20DE	Wiggins	1.25in Tube Connector
W991-24DE	Wiggins	1.5in Tube Connector
W991-28DE	Wiggins	1.75in Tube Connector
W991-32DE	Wiggins	2in Tube Connector
W991-40DE	Wiggins	2.5in Tube Connector
W991-48DE	Wiggins	3in Tube Connector
W991-64DE	Wiggins	4in Tube Connector
W994-16D	Wiggins	1in Tube Clamp Only

## Metal Brake Tube & Fittings



Construction: Kunifer seamless copper alloy tube, guaranteed against corrosion for life of vehicle. Application: All brake lines where flexibility is not required. The tube may be bent by hand or using a tool where tighter radiuses are required. A flaring tool is required to form a seating.

More fittings available, please enquire.

Part No	Wiggins	Tube Connector
KP1-3	3/16in OD Kunifer Brake Pipe	25ft Roll
TN1-3	Male Tube Nut	3/8x24UNF For 3/16in OD
TN1S-4	Male Tube Nut	7/16x20UNF For 3/16in OD
TN1-31	Male Tube Nut	M10x1 For 3/16in OD
TN2-3	Female Tube Nut	3/8x24UNF For 3/16in OD
TN2-31	Female Tube Nut	M10x1 For 3/16in OD
KP-4	1/4in OD Kunifer Brake Pipe	25 Foot Roll
TN1-4	Male Tube Nut	7/16x20UNF For 1/4in OD
TN4-4	Male Tube Nut	7/16x24UNF For 3/16in OD
TN2-4	Female Tube Nut	7/16x20UNF For 1/4in OD

## Aluminium Tube & Fittings



Application: Used mainly for in cockpit/cabin for fuel, oil & fire extinguisher lines, where weight saving is the prime consideration. Construction: A compression fitting system used in conjunction with specially supplied aluminium tube coated in plastic (Polymide 12) for corrosion resistance. All female JIC fittings are red / blue anodised, metric are black / gold. We currently stock 10mm tube & fittings, also available in 4.75mm and 8mm, larger sizes are in the pipeline.

Part No	Wiggins	Tube Connector
AT-5	4.75mm OD Aluminium Tube	(Per Metre)
AT-8	8mm OD Aluminium Tube	(Per Metre)
AT-10	10mm OD Aluminium Tube	(Per Metre)
TEB	Through Bulkhead Straight Tube Joiner	For AT-10
TEB45	Through Bulkhead 45° Tube Joiner	For AT-10
TEB90	Through Bulkhead 90° Tube Joiner	For AT-10
TEBAN-M12	Tube End Banjo	For M12x1.5 Bolt For AT-10
TEBAND-M12	Tube End Double Banjo	For M12x1.5 Bolt For AT-10
TEF2-55	Tube End Straight Female	M14x1.5 For AT-10
TEF7-6	Tube End Straight Female	-6JIC For AT-10
TEF92-55	Tube End 90° Female	M14x1.5 For AT-10
TEF97-6	Tube End 90° Female	-6JIC For AT-10
TEM2-55	Tube End Straight Male	M14x1.5 For AT-10
TEM3-4	Tube End Straight Male	1/4BSP For AT-10
TEM7-6	Tube End Straight Male	-6JIC For AT-10
TEMB47-6	Tube End 45° Male Bulkhead	-6JIC For AT-10
TEMB7-6	Tube End Straight Male Bulkhead	-6JIC For AT-10
TEMB92-55	Tube End 90° Male Bulkhead	M14x1.5 For AT-10
TEMB97-6	Tube End 90° Male Bulkhead	-6JIC For AT-10
TET	Tube End T Tube/Tube/Tube	For AT-10
TETF7-6	Tube End T Tube/-6JIC/Tube	For AT-10

## Tube Nut & Sleeve (AN818/9)



Aeroquip two part blue anodised aluminium female JIC fitting for attachment to Bundy, Kunifer, steel or aluminium tube, requires the use of a flaring tool.

### Aluminium

Part No	Wiggins	Tube Connector
FBM3554	-3JIC Tube Nut	
FBM3555	-4JIC Tube Nut	
FBM3675	-6JIC Tube Nut	
FBM3676	-8JIC Tube Nut	
FBM3677	-10JIC Tube Nut	
FBM3678	-12JIC Tube Nut	

### Aluminium

Part No	Wiggins	Tube Connector
FBM3669	-3JIC Tube Sleeve	
FBM3670	-4JIC Tube Sleeve	
FBM3671	-6JIC Tube Sleeve	
FBM3672	-8JIC Tube Sleeve	
FBM3673	-10JIC Tube Sleeve	
FBM3674	-12JIC Tube Sleeve	

## Flareless Tube Fitting



Aeroquip Versaflare two part plated mild steel, as above but no flaring tool required. Use with steel male unions.

### Steel

Part No	Wiggins	Tube Connector
VFS-4	-4JIC For 1/4in Tube	
VFS-5	-5JIC For 5/16in Tube	
VFS-6	-6JIC For 3/8in Tube	
VFS-8	-8JIC For 1/2in Tube	
VFS-10	-10JIC For 5/8in Tube	
VFS-12	-12JIC For 3/4in Tube	

## Hose Assembly Tools

### Aluminium Vice Jaw Inserts



Construction: Aluminium die casting with angled pockets to hold any size hexagon and horizontal pocket to hold all sizes of hose. Cast in magnets hold jaws firmly to vice. Application: Holds anodised fittings during assembly to minimise marking the finish and allows hose to be held firmly during cutting operation.

Part No	
FCM3661	Alloy Vice Jaws
AVJ1	As Above But Made From Billet Aluminium

### Aluminium Spanners



These billet aluminium spanners fit the actual swivel hexagon, ideal for tightening assembled connections. We also have a set with removable handles that can be fitted at different angles. For assembly of the fitting we also have a kit with blue spanners fitting the "B" nut and red the socket.

Part No	
FCM3410	Aeroquip Spanner Set- -6 To -20
AS7-3	-3 Spanner
AS7-4	-4 Spanner
AS7-6	-6 Spanner
AS7-8	-8 Spanner
AS7-10	-10 Spanner
AS7-12	-12 Spanner
AS7-16	-16 Spanner
ASS7-4-16	-4 To -16 Fitting Assembly Set

### Braided TFE Tube Seating Tool



Hand held tool to facilitate seating TFE tube against sleeve.

Part No	
FBM3646	-3 To -12 Assembly Tool

### Braided TFE Braid Separating Tool



Hand held tool that uses twisting action to flare stainless braid away from -3 & -4 hose.

Part No	
TAT-3-4	-3 & -4 Braid Flaring Tool

### Thread Identification Kit



Kit consisting of special calliper, thread gauge, dimension booklet & magnifying glass

Part No	
FCM3644	Thread Identification Kit

### Aeroquip Socketless Hose Assembly Tool



The FT1268 / FBM3632 hand held assembly tool designed for assembly of -4,-6 & -8 straight fittings into push on hose, tool for angled fittings available soon. The hose is held in position by manually operated clamp, and the fitting is positioned on the mandrel assembly lever. The fitting is pushed into the hose by compressing the mandrel assembly lever.

Part No	
FBM3632	-4,-6,-8 Push On Hose Tool

### Pipe Beading Tool



Used to create a bead in the pipe as shown above, to give silicone hoses something to grip to and stop from slipping off.

Part No	
PBT1	Pipe Beading Tool



## Adapters

We stock a vast range of adapters in a variety of materials and add to the range regularly. If you cannot see what you are looking for, please ask as we may have added it already. The items listed in our price list are usually available from stock. Most aluminium adapters are blue but most FBM numbers are also available in black

### Male To Male, Straight

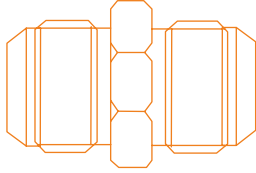

#### JIC To JIC Equal (AN815) And Reducing (AN919)

##### Aluminium

###### Part No

FBM2050	-3JIC X	-3JIC Aeroquip Blue
FBM2048	-4JIC X	-3JIC Aeroquip Blue
FBM2051	-4JIC X	-4JIC Aeroquip Blue
AN919-6-3	-6JIC X	-3JIC Blue
FBM2156	-6JIC X	-4JIC Aeroquip Blue
FBM2052	-6JIC X	-6JIC Aeroquip Blue
FBM2049	-8JIC X	-4JIC Aeroquip Blue
FBM2160	-8JIC X	-6JIC Aeroquip Blue
FBM2053	-8JIC X	-8JIC Aeroquip Blue
FBM2188	-10JIC X	-4JIC Aeroquip Blue
FBM2162	-10JIC X	-6JIC Aeroquip Blue
FBM2163	-10JIC X	-8JIC Aeroquip Blue
FBM2054	-10JIC X	-10JIC Aeroquip Blue
FBM2189	-12JIC X	-4JIC Aeroquip Blue
FBM2165	-12JIC X	-6JIC Aeroquip Blue
FBM2166	-12JIC X	-8JIC Aeroquip Blue
FBM2167	-12JIC X	-10JIC Aeroquip Blue
FBM2055	-12JIC X	-12JIC Aeroquip Blue
FBM2169	-16JIC X	-10JIC Aeroquip Blue
FBM2170	-16JIC X	-12JIC Aeroquip Blue
FBM2056	-16JIC X	-16JIC Aeroquip Blue
AN919-20-16	-20JIC X	-16JIC Blue
FBM5050	-3JIC X	-3JIC M/M Aeroquip Black
FBM5051	-4JIC X	-4JIC M/M Aeroquip Black
FBM5052	-6JIC X	-6JIC M/M Aeroquip Black
FBM5053	-8JIC X	-8JIC M/M Aeroquip Black
FBM5054	-10JIC X	-10JIC M/M Aeroquip Black
FBM5055	-12JIC X	-12JIC M/M Aeroquip Black
FBM5056	-16JIC X	-16JIC M/M Aeroquip Black
FBM5048	-4JIC X	-3JIC M/M Aeroquip Black
FBM5156	-6JIC X	-4JIC M/M Aeroquip Black
FBM5049	-8JIC X	-4JIC M/M Aeroquip Black
FBM5160	-8JIC X	-6JIC M/M Aeroquip Black
FBM5162	-10JIC X	-6JIC M/M Aeroquip Black
FBM5163	-10JIC X	-8JIC M/M Aeroquip Black
FBM5166	-12JIC X	-8JIC M/M Aeroquip Black
FBM5167	-12JIC X	-10JIC M/M Aeroquip Black
FBM5170	-16JIC X	-12JIC M/M Aeroquip Black

##### Steel

###### Part No

MMS57-3	-3JIC X	-3JIC, Stainless
MMS57-3-4	-3JIC X	-4JIC, Stainless
FBM2750	-3JIC X	-3JIC
MMS7-3-4	-3JIC X	-4JIC
FBM2751	-4JIC X	-4JIC
MMS7-4-5	-4JIC X	-5JIC (1/2UNF X 20TPI)
FBM2754	-4JIC X	-6JIC
MMS7-5	-5JIC X	-5JIC
FBM2756	-6JIC X	-6JIC
MMS7-6-8	-6JIC X	-8JIC
MMS7-6-10	-6JIC X	-10JIC
MMS7-6-12	-6JIC X	-12JIC
MMS7-8-8	-8JIC X	-8JIC
MMS7-8-10	-8JIC X	-10JIC
MMS7-8-12	-8JIC X	-12JIC
MMS7-10-10	-10JIC X	-10JIC
MMS7-10-12	-10JIC X	-12JIC
MMS7-10-16	-10JIC X	-16JIC
MMS7-12-12	-12JIC X	-12JIC
MMS7-12-16	-12JIC X	-16JIC
MMS7-16-16	-16JIC X	-16JIC
MMS7-20-20	-20JIC X	-20JIC

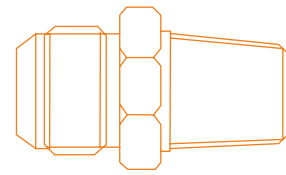

#### JIC To NPTF (AN816)

##### Aluminium

###### Part No

FBM2000	-3JIC X 1/8NPTF Aeroquip Blue
FBM2001	-4JIC X 1/8NPTF Aeroquip Blue
FBM2002	-4JIC X 1/4NPTF Aeroquip Blue
FBM2003	-6JIC X 1/8NPTF Aeroquip Blue
FBM2004	-6JIC X 1/4NPTF Aeroquip Blue
FBM2005	-6JIC X 3/8NPTF Aeroquip Blue
FBM2013	-6JIC X 1/2NPTF Aeroquip Blue
FBM2006	-8JIC X 1/4NPTF Aeroquip Blue
FBM2007	-8JIC X 3/8NPTF Aeroquip Blue
FBM2008	-8JIC X 1/2NPTF Aeroquip Blue
AN816-10-4	-10JIC X 1/4NPTF Blue
FBM2185	-10JIC X 3/8NPTF Aeroquip Blue
FBM2009	-10JIC X 1/2NPTF Aeroquip Blue
FBM2010	-12JIC X 1/2NPTF Aeroquip Blue
FBM2011	-12JIC X 3/4NPTF Aeroquip Blue
AN816-16-12	-16JIC X 3/4NPTF Blue
FBM2012	-16JIC X 1" NPTF Aeroquip Blue
FBM5000	-3JIC X 1/8NPT Aeroquip Black
FBM5001	-4JIC X 1/8NPT Aeroquip Black
FBM5002	-4JIC X 1/4NPT Aeroquip Black
FBM5003	-6JIC X 1/8NPT Aeroquip Black
FBM5004	-6JIC X 1/4NPT Aeroquip Black
FBM5005	-6JIC X 3/8NPT Aeroquip Black
FBM5013	-6JIC X 1/2NPT Aeroquip Black
FBM5006	-8JIC X 1/4NPT Aeroquip Black
FBM5007	-8JIC X 3/8NPT Aeroquip Black
FBM5008	-8JIC X 1/2NPT Aeroquip Black
FBM5185	-10JIC X 3/8NPT Aeroquip Black
FBM5009	-10JIC X 1/2NPT Aeroquip Black
FBM5010	-12JIC X 1/2NPT Aeroquip Black
FBM5011	-12JIC X 3/4NPT Aeroquip Black
FBM5015	-16JIC X 3/4NPT Aeroquip Black

##### Steel

###### Part No

FBM2511	-3JIC X 1/8NPTF
FBM2512	-4JIC X 1/8NPTF
FBM2515	-4JIC X 1/4NPTF
FBM2519	-4JIC X 3/8NPTF
FBM2524	-4JIC X 1/2NPTF
MMS8-5-3	-5JIC X 1/8NPTF
MMS8-6-3	-6JIC X 1/8NPTF
FBM2517	-6JIC X 1/4NPTF
FBM2521	-6JIC X 3/8NPTF
MMS8-6-8	-6JIC X 1/2NPTF
FBM2518	-8JIC X 1/4NPTF
FBM2522	-8JIC X 3/8NPTF
FBM2526	-8JIC X 1/2NPTF
MMS8-10-4	-10JIC X 1/4NPTF
MMS8-10-6	-10JIC X 3/8NPTF
FBM2527	-10JIC X 1/2NPTF
FBM2531	-10JIC X 3/4NPTF
FBM2528	-12JIC X 1/2NPTF
FBM2532	-12JIC X 3/4NPTF
MMS8-16-12	-16JIC X 3/4NPTF

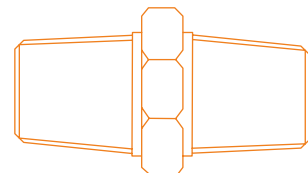

#### NPTF To NPTF (AN911)

##### Aluminium

###### Part No

FBM2132	1/8NPTF Aeroquip Blue
FBM2133	1/4NPTF Aeroquip Blue
FBM2134	3/8NPTF Aeroquip Blue
FBM2135	1/2NPTF Aeroquip Blue

##### Steel

###### Part No

MMS8-4-4	1/4NPTF
----------	---------

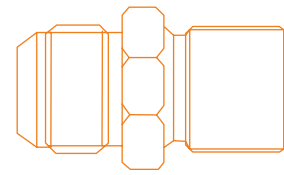
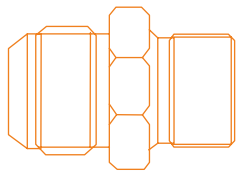

### JIC To BSP

#### Aluminium

##### Part No

MMA-3	-3JIC X 1/8BSP
MMA-3-4	-3JIC X 1/4BSP
MMA-4-3	-4JIC X 1/8BSP
MMA-4-4	-4JIC X 1/4BSP
MMA-4-6	-4JIC X 3/8BSP
MMA-6-3	-6JIC X 1/8BSP
MMA-6-4	-6JIC X 1/4BSP
MMA-6-6	-6JIC X 3/8BSP
MMA-6-8	-6JIC X 1/2BSP
MMA-8-4	-8JIC X 1/4BSP
MMA-8-6	-8JIC X 3/8BSP
MMA-8	-8JIC X 1/2BSP
MMA-10-6	-10JIC X 3/8BSP
MMA-10-8	-10JIC X 1/2BSP
MMA-10	-10JIC X 5/8BSP
MMA-10-12	-10JIC X 3/4BSP
MMA-12-8	-12JIC X 1/2BSP
MMA-12-10	-12JIC X 5/8BSP
MMA-12	-12JIC X 3/4BSP
MMA-16-10	-16JIC X 5/8BSP

#### Steel

##### Part No

MMSO-3-4	1/8BSP X -4JIC
MMSO-3-5	1/8BSP X -5JIC (1/2UNF X 20TPI)
MMSO-3-6	1/8BSP X -6JIC
MMSO-4-4	1/4BSP X -4JIC
MMSO-4-5	1/4BSP X -5JIC (1/2UNF X 20TPI)
MMSO-4-6	1/4BSP X -6JIC
MMSO-4-8	1/4BSP X -8JIC
MMSO-4-10	1/4BSP X -10JIC
MMSO-6-4	3/8BSP X -4JIC
MMSO-6-5	3/8BSP X -5JIC
MMSO-6-6	3/8BSP X -6JIC
MMSO-6-8	3/8BSP X -8JIC
MMSO-6-10	3/8BSP X -10JIC
MMSO-6-12	3/8BSP X -12JIC
MMSO-8-4	1/2BSP X -4JIC
MMSO-8-6	1/2BSP X -6JIC
MMSO-8-8	1/2BSP X -8JIC
MMSO-8-10	1/2BSP X -10JIC
MMSO-8-12	1/2BSP X -12JIC
MMSO-8-16	1/2BSP X -16JIC
MMSO-10-6	5/8BSP X -6JIC
MMSO-10-8	5/8BSP X -8JIC
MMSO-10-10	5/8BSP X -10JIC
MMSO-10-12	5/8BSP X -12JIC
MMSO-12-4	3/4BSP X -4JIC
MMSO-12-6	3/4BSP X -6JIC
MMSO-12-8	3/4BSP X -8JIC
MMSO-12-10	3/4BSP X -10JIC
MMSO-12-12	3/4BSP X -12JIC
MMSO-12-16	3/4BSP X -16JIC
MMSO-12-20	3/4BSP X -20JIC

### JIC To UNF With Flat Seat Or Inverted Flare (American Fuel Pumps)

#### Aluminium

##### Part No

FBM2108	-6JIC X 5/8-18 Inverted Flare Fuel Pump
FBM2111	-6JIC X 1/2-20 Inverted Flare Fuel Pump
FBM2112	-6JIC X 5/8-20 Carter Carb
MMA1-6-4	-6JIC X 7/16-244
FBM2107	-6JIC X 1-20 Rochester Quadrajat
FBM2113	-6JIC X 9/16-24 Single Feed Holley
FBM2114	-6JIC X 7/8-20 Dual Feed Holley
FBM2110	-8JIC X 7/8-20 Dual Feed Holley
MMA1-10-7	-10JIC X 5/8UNF
FBM2953	-10JIC X 7/8UNF With O-Ring
MMA1-10-2	-10JIC X 1 1/16 -16 Jaguar Flat End
MMA1-12-8	-12JIC X 3/4UNF
MMA1-12-10	-12JIC X 7/8UNF
FBM2954	-12JIC X 7/8UNF With O-Ring
FBM2955	-12JIC X 1 1/16 -12UNF With O-Ring
MMA1-J-1	-12JIC X 1 1/16 14TPI Jaguar Concave Seat
MMA1-J-2X	-12JIC X 1 1/16 14TPI Jaguar Convex Seat

#### Steel

##### Part No

FBM2963	-6JIC X 1/2-20 Inverted Flare
MMS1-6-7	-6JIC X 5/8-18 Inverted Flare

### FBM2965

-6JIC X 11/16-18 Inverted Flare

### JIC To UNF

#### Steel

##### Part No

MMSS1-3	-3JIC X 3/8UNF Flat Seat, Stainless
MMS1-3	-3JIC X 3/8UNF
MMS1-4	-4JIC X 7/16UNF
MMS1-4-4F	-4JIC X 7/16-24
MMS1-4-5	-4JIC X 1/2UNF
MMS1-6-5	-6JIC X 1/2UNF
MMS1-8	-8JIC X 7/8UNF
MMS1-10-8	-10JIC X 3/4UNF
MMS1-10-16	-10JIC X 1 UNF
MMS1-12	-12JIC X 3/4UNF
MMS1-12-8	-12JIC X 7/8UNF

### JIC To Metric

#### Aluminium

##### Part No

MMA2-3-31	-3JIC X M10x1 Convex Seat
MMA2-3-32	-3JIC X M10x1.25 Convex Seat
MMA2-3-41	-3JIC X M12x1.0 Convex Seat
MMA2-3-42	-3JIC X M12x1.25 Convex Seat
MMA2-4-31	-4JIC X M10x1 Convex Seat
MMA2-4-41	-4JIC X M12x1.0 Convex Seat
MMA2-4-42	-4JIC X M12x1.25 Convex Seat
MMA2-4-55	-4JIC X M14x1.5
MMA2-4-65	-4JIC X M16x1.5
MMA2-4-85	-4JIC X M18x1.5
MMA2-6-31	-6JIC X M10x1.0
MMA2-6-35	-6JIC X M10x1.5
MMA2-6-41	-6JIC X M12x1.0
MMA2-6-42	-6JIC X M12x1.25
FBM2116	-6JIC X M12x1.5 - Weber-Flat
MMA2-6-45	-6JIC X M12x1.5
MMA2-6-55	-6JIC X M14x1.5
MMA2-6-65	-6JIC X M16x1.5
MMA2-6-85	-6JIC X M18x1.5
MMA2-6-45-O	-6JIC X M12x1.5 - Saginaw p/s- GM Fuel Injection
MMA2-6-55-O	-6JIC X M14x1.5 - Saginaw p/s- GM Fuel Injection
MMA2-6-65-O	-6JIC X M16x1.5 - Saginaw p/s- GM Fuel Injection
MMA2-6-85-O	-6JIC X M18x1.5 - Saginaw p/s- GM Fuel Injection
MMA2-8-55	-8JIC X M14x1.5
MMA2-8-65	-8JIC X M16x1.5
MMA2-8-85	-8JIC X M18x1.5
MMA2-10-65	-10JIC X M16x1.5
MMA2-10-85	-10JIC X M18x1.5
MMA2-10-95	-10JIC X M20x1.5
MMA2-12-65	-12JIC X M16x1.5
MMA2-12-85	-12JIC X M18x1.5
MMA2-12-95	-12JIC X M20x1.5
MMA2-12-105	-12JIC X M22x1.5
MMA2-12-115	-12JIC X M24x1.5
MMA2-12-125	-12JIC X M26x1.5
MMA2-12-145	-12JIC X M28x1.5
MMA2-12-165	-12JIC X M30x1.5
MMA2-16-125	-16JIC X M26x1.5
MMA2-16-165	-16JIC X M30x1.5

#### Steel

##### Part No

MMSS2-3-31	-3JIC X M10x1.0 Convex Seat, Stainless
MMS2-3-31X	-3JIC X M10x1.0 Convex Seat
MMS2-31	-3JIC X M10x1.0 Flat Seat
FBM2942	-3JIC X M10x1.25 Convex Seat
MMS2-4-31	-4JIC X M10x1 Convex Seat
MMS2-4-41	-4JIC X M12x1 Convex Seat
MMS2-6-31	-6JIC X M10x1.0
MMS2-6-45	-6JIC X M12x1.5
MMS2-6-55	-6JIC X M14x1.5
MMS2-6-65	-6JIC X M16x1.5
FBM2608	-6JIC X M16x1.5 - Saginaw p/s- GM Fuel Injection
FBM2609	-6JIC X M18x1.5 - Saginaw p/s- GM Fuel Injection
MMS2-6-85	-6JIC X M18x1.5
MMS2-6-95	-6JIC X M20x1.5
MMS2-8-55	-8JIC X M14x1.5
MMS2-8-65	-8JIC X M16x1.5
MMS2-8-85	-8JIC X M18x1.5
MMS2-10-65	-10JIC X M16x1.5
MMS2-10-85	-10JIC X M18x1.5
MMS2-16-125	-16JIC X M25x1.5

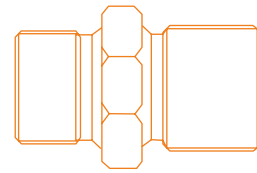
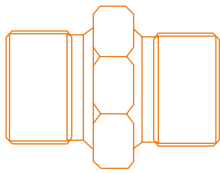

### BSP To BSP

#### Aluminium

##### Part No

MMA3-3-6	1/8BSP X 3/8BSP
MMA3-6-8	3/8BSP X 1/2BSP
MMA3-8	1/2BSP X 1/2BSP
MMA3-8-10	1/2BSP X 5/8BSP
MMA3-10	5/8BSP X 5/8BSP

#### Steel

##### Part No

MMS3-3-3	1/8BSP X 1/8BSP
MMS3-3-4	1/8BSP X 1/4BSP
MMS3-3-6	1/8BSP X 3/8BSP
MMS3-3-8	1/8BSP X 1/2BSP
MMS3-4-4	1/4BSP X 1/4BSP
MMS3-4-6	1/4BSP X 3/8BSP
MMS3-4-8	1/4BSP X 1/2BSP
MMS3-6-6	3/8BSP X 3/8BSP
MMS3-6-8	3/8BSP X 1/2BSP
MMS3-6-10	3/8BSP X 5/8BSP
MMS3-8-8	1/2BSP X 1/2BSP
MMS3-8-10	1/2BSP X 5/8BSP
MMS3-8-12	1/2BSP X 3/4BSP
MMS3-10-10	5/8BSP X 5/8BSP
MMS3-10-12	5/8BSP X 3/4BSP
MMS3-12-12	3/4BSP X 3/4BSP

### BSP To BSPT

#### Steel

##### Part No

MMS6-3-3	1/8BSP X 1/8BSPT
MMS6-3-4	1/8BSP X 1/4BSPT
MMS6-3-6	1/8BSP X 3/8BSPT
MMS6-4-3	1/4BSP X 1/8BSPT
MMS6-4-4	1/4BSP X 1/4BSPT
MMS6-4-6	1/4BSP X 3/8BSPT
MMS6-6-3	3/8BSP X 1/8BSPT
MMS6-6-4	3/8BSP X 1/4BSPT
MMS6-6-6	3/8BSP X 3/8BSPT
MMS6-6-8	3/8BSP X 1/2BSPT
MMS6-8-4	1/2BSP X 1/4BSPT
MMS6-8-6	1/2BSP X 3/8BSPT
MMS6-8-8	1/2BSP X 1/2BSPT
MMS6-10-10	5/8BSP X 5/8BSPT
MMS6-12-8	3/4BSP X 1/2BSPT

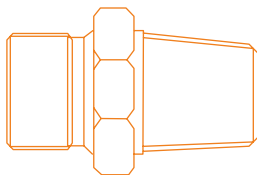

### BSP To NPTF

#### Steel

##### Part No

MMS10-3-3	1/8BSP X 1/8NPTF
MMS10-3-4	1/8BSP X 1/4NPTF
MMS10-4-3	1/4BSP X 1/8NPTF
MMS10-4-4	1/4BSP X 1/4NPTF
MMS10-4-6	1/4BSP X 3/8NPTF
MMS10-4-8	1/4BSP X 1/2NPTF
MMS10-6-3	3/8BSP X 1/8NPTF
MMS10-6-4	3/8BSP X 1/4NPTF
MMS10-6-6	3/8BSP X 3/8NPTF
MMS10-6-8	3/8BSP X 1/2NPTF
MMS10-8-4	1/2BSP X 1/4NPTF
MMS10-8-6	1/2BSP X 3/8NPTF
MMS10-8-8	1/2BSP X 1/2NPTF
MMS10-10-6	5/8BSP X 3/8NPTF
MMS10-10-8	5/8BSP X 1/2NPTF
MMS10-12-4	3/4BSP X 1/4NPTF
MMS10-12-6	3/4BSP X 3/8NPTF
MMS10-12-8	3/4BSP X 1/2NPTF

### BSP To BSF

#### Steel

##### Part No

MMS11-3	1/8BSP X 3/8BSF
---------	-----------------

### BSP To UNF

#### Aluminium

##### Part No

MMA4-8	1/2BSP X 3/4UNF Extended
MMA4-10-J	5/8BSP X 1-16 Jaguar

#### Steel

##### Part No

MMS9-3	1/8BSP X 3/8UNF
MMS9-3X	1/8BSP X 3/8UNF Convex Seat
MMS9-3V	1/8BSP X 3/8UNF Concave Seat
MMS9-3-4	1/8BSP X 7/16UNF
MMS9-3-4X	1/8BSP X 7/16UNF Convex Seat
MMS9-3-4V	1/8BSP X 7/16UNF Concave Seat
MMS9-3-4F	1/8BSP X 7/16X24TPI
MMS9-3-4FX	1/8BSP X 7/16X24TPI Convex Seat
MMS9-3-4FV	1/8BSP X 7/16X24TPI Concave Seat
MMS9-3-5V	1/8BSP X 1/2UNF Concave Seat
MMS9-3-6V	1/8BSP X 9/16UNF Concave Seat
MMS9-3-7	1/8BSP X 5/8UNF
MMS9-4-3	1/4BSP X 3/8UNF
MMS9-4-4	1/4BSP X 7/16UNF
MMS9-4-4X	1/4BSP X 7/16UNF Convex Seat
MMS9-4-6	1/4BSP X 9/16 X 18 TPI
MMS9-4-6FX	1/4BSP X 9/16 X 24 TPI Convex Seat
MMS9-6-5	3/8BSP X 1/2UNF
MMS9-6-7	3/8BSP X 5/8UNF For Smiths Temp Gauge
MMS9-8-7	1/2BSP X 5/8UNF
MMS9-8-8	1/2BSP X 3/4UNF
MMS9-8-10	1/2BSP X 7/8UNF
MMS9-10-8	5/8BSP X 3/4UNF
MMS9-10-10	5/8BSP X 7/8UNF
MMS9-12-8	3/4BSP X 3/4UNF
MMS9-12-10	3/4BSP X 7/8UNF

### BSP To Metric

#### Aluminium

##### Part No

MMA5-10-85	5/8BSP X M18x1.5
------------	------------------

#### Steel

##### Part No

MMS5-3-31	1/8BSP X M10x1.0 Flat Seat
MMS5-3-31X	1/8BSP X M10x1.0 Convex Seat
MMS5-3-31V	1/8BSP X M10x1.0 Concave Seat
MMS5-3-32	1/8BSP X M10x1.25 Flat Seat
MMS5-3-32X	1/8BSP X M10x1.25 Convex Seat
MMS5-3-32V	1/8BSP X M10x1.25 Concave Seat
MMS5-3-35	1/8BSP X M10x1.5
MMS5-3-41	1/8BSP X M12x1 Flat Seat
MMS5-3-41V	1/8BSP X M12x1 Concave Seat
MMS5-3-42	1/8BSP X M12x1.25
MMS5-3-45	1/8BSP X M12x1.5 Flat Seat
MMS5-3-45X	1/8BSP X M14x1.5 Convex Seat
MMS5-4-31	1/4BSP X M10x1.0 Flat Seat
MMS5-4-35	1/4BSP X M10x1.5
MMS5-4-41	1/4BSP X M12x1.0 Flat Seat
MMS5-4-42	1/4BSP X M12x1.25 Flat Seat
MMS5-4-42V	1/4BSP X M12x1.25 Concave Seat
MMS5-4-45	1/4BSP X M12x1.5
MMS5-4-55	1/4BSP X M14x1.5
MMS5-4-65	1/4BSP X M16x1.5
MMS5-6-31	3/8BSP X M10x1.0
MMS5-6-45	3/8BSP X M12x1.5
MMS5-6-55	3/8BSP X M14x1.5
MMS5-6-65	3/8BSP X M16x1.5
MMS5-6-85	3/8BSP X M18x1.5
MMS5-6-95	3/8BSP X M20x1.5
MMS5-8-65	1/2BSP X M16x1.5
MMS5-8-85	1/2BSP X M18x1.5
MMS5-8-95	1/2BSP X M20x1.5
MMS5-8-105	1/2BSP X M22x1.5
MMS5-8-115	1/2BSP X M24x1.5
MMS5-8-125	1/2BSP X M26x1.5
MMS5-10-85	5/8BSP X M18x1.5
MMS5-10-105	5/8BSP X M22x1.5
MMS5-10-125	5/8BSP X M26x1.5
MMS5-12-85	3/4BSP X M18x1.5
MMS5-12-95	3/4BSP X M20x1.5
MMS5-12-105	3/4BSP X M22x1.5
MMS5-12-115	3/4BSP X M24x1.5
MMS5-12-125	3/4BSP X M26x1.5

## Filtered Adapters



A range of adapters with a coarse mesh screen filter for protecting dry sump pumps etc.

Part No	
MMA1-10-12-FS	-10JIC X1 1/16 UNF C/W Filter
MMA1-12-12-FS	-12JIC X1 1/16 UNF C/W Filter
MMA1-16-12-FS	-16JIC X1 1/16 UNF C/W Filter
MEF7-6	-6JIC Male End Filter 250Mic
MEF7-8	-8JIC Male End Filter 250Mic
MEF7-10	-10JIC Male End Filter 250Mic
MEF7-12	-12JIC Male End Filter 250Mic

## Male To Female, Straight



<b>JIC To JIC</b>	
<b>Aluminium</b>	
Part No	
MFA7-3-4	-3JIC Male X -4JIC Female - Non Swivel
MFA7-3-6	-3JIC Male X -6JIC Female - Non Swivel
MFA7-4-6	-4JIC Male X -6JIC Female - Non Swivel
MFA7-6-8	-6JIC Male X -8JIC Female - Non Swivel
MFA7-6-10	-6JIC Male X -10JIC Female - Non Swivel
MFA7-8-10	-8JIC Male X -10JIC Female - Non Swivel
MFA7-8-12	-8JIC Male X -12JIC Female - Non Swivel
MFA7-10-12	-10JIC Male X -12JIC Female - Non Swivel
MFA7-12-16	-12JIC Male X -16JIC Female - Non Swivel
MFA7-4-3	-4JIC Male X -3JIC Female - Non Swivel
MFA7-6-4	-6JIC Male X -4JIC Female - Non Swivel
MFA7-8-6	-8JIC Male X -6JIC Female - Non Swivel
MFA7-10-8	-10JIC Male X -8JIC Female - Non Swivel
MFA7-12-10	-12JIC Male X -10JIC Female - Non Swivel
MFA7-16-12	-16JIC Male X -12JIC Female - Non Swivel

<b>Steel</b>	
Part No	
MFS7-4-6	-4JIC Male X -6JIC Female - Swivel
MFS7-5-4	-5JIC Male X -4JIC Female - Swivel
MFS7-5-5	-5JIC Male X -5JIC Female - Swivel
MFS7-5-6	-5JIC Male X -6JIC Female - Swivel
MFS7-6-4	-6JIC Male X -4JIC Female - Swivel
MFS7-6-5	-6JIC Male X -5JIC Female - Swivel
MFS7-6-6	-6JIC Male X -6JIC Female - Swivel
MFS7-6-8	-6JIC Male X -8JIC Female - Swivel
MFS7-8-6	-8JIC Male X -6JIC Female - Swivel
MFS7-8-8	-8JIC Male X -8JIC Female - Swivel
MFS7-10-12	-10JIC Male X -12JIC Female - Swivel
MFS7-12	-12JIC Male X -12JIC Female - Swivel

<b>Stainless Steel</b>	
Part No	
MFSS7-3-4	-3JIC Male X -4JIC Female - Swivel
MFSS7-3-6	-3JIC Male X -6JIC Female - Swivel
MFSS7-4-6	-4JIC Male X -6JIC Female - Swivel
MFSS7-6-4	-6JIC Male X -4JIC Female - Swivel
MFSS7-6-8	-6JIC Male X -8JIC Female - Swivel
MFSS7-8-10	-8JIC Male X -10JIC Female - Swivel

<b>Aluminium</b>	
Part No	
MFA2-6-45X	-6JIC Male X M12x1.5 Female Convex Seat - Swivel
MFA2-6-55X	-6JIC Male X M14x1.5 Female Convex Seat - Swivel
MFA2-12-165	-12JIC Mle X M30x1.5 Fml Concave Seat (Porsche) - Swivel
MFA2-16-165	-16JIC Mle X M30x1.5 Fml Concave Seat (Porsche) - Swivel
MFA2-12-125	-12JIC Mle X M26x1.5 Fml Concave Seat (Porsche) - Swivel
MFA2-3-31	-3JIC Male X M10x1.0 Female Concave Seat - Non Swivel
MFA2-6-45	-6JIC Male X M12x1.5 Female Concave Seat - Non Swivel
MFA2-6-55	-6JIC Male X M14x1.5 Female Concave Seat - Non Swivel

<b>NPTF To NPTF (AN912)</b>	
<b>Aluminium</b>	
Part No	
FBM2136	1/4NPTF Male X 1/8NPTF Female - Non Swivel
FBM2137	3/8NPTF Male X 1/4NPTF Female - Non Swivel
FBM2138	3/8NPTF Male X 1/8NPTF Female - Non Swivel
FBM2139	1/2NPTF Male X 3/8NPTF Female - Non Swivel
FBM2140	1/2NPTF Male X 1/4NPTF Female - Non Swivel
FBM2141	1/2NPTF Male X 1/8NPTF Female - Non Swivel
FBM2144	3/4NPTF Male X 1/4NPTF Female - Non Swivel
FBM2143	3/4NPTF Male X 3/8NPTF Female - Non Swivel
FBM2142	3/4NPTF Male X 1/2NPTF Female - Non Swivel

Change FBM2\*\*\* part number to FBM5\*\*\* for black anodised finish

<b>Steel</b>	
Part No	
MFS8-3-3	1/8NPTF Male X 1/8NPTF Female - Swivel
MFS8-4-2	1/4NPTF Male X 1/8NPTF Female - Swivel

<b>JIC To BSP</b>	
<b>Steel</b>	
Part No	
MFS0-6-4	-6JIC Male X 1/4BSP Female - Swivel
MFS0-6-6	-6JIC Male X 3/8BSP Female - Swivel
MFS0-8-8	-8JIC Male X 1/2BSP Female - Swivel
MFS0-10-8	-10JIC Male X 1/2BSP Female - Swivel
MFS0-10-10	-10JIC Male X 5/8BSP Female - Swivel
MFS0-12-8	-12JIC Male X 1/2BSP Female - Swivel

<b>BSP To BSP</b>	
<b>Steel</b>	
Part No	
MFS3-8-10	5/8BSP M X 1/2BSP F Cooler Connector Converter - Swivel
MFS3-8-3	1/2BSP Male X 1/8BSP Female - Swivel
MFS3-8-6	1/2BSP Male X 3/8BSP Female - Swivel
MFS3-8-6S	1/2BSP Male X 3/8BSP Female TGASP Port To Temp Gauge
MFS3-8-8	1/2BSP Male X 1/2BSP Female - Swivel
MFS6-4-4	1/4BSP Male X 1/4BSP Female - Swivel

<b>BSP To NPTF</b>	
<b>Steel</b>	
Part No	
MFS6-3-3	1/8BSPT Male X 1/8NPTF Female - Swivel
MFS10-8-3	1/2BSP Male X 1/8NPTF Female - Non Swivel
MFS10-8-4	1/2BSP Male X 1/4NPTF Female - Non Swivel
MFS10-8-6	1/2BSP Male X 3/8NPTF Female - Non Swivel
MFS10-3-3	1/8BSP Ml X 1/8NPTF Fml USA Made Gauges - Non Swivel
MFS10-6-4	3/8NPTF X 1/4BSP Holley Reg Pressure T/O - Non Swivel

<b>BSP To Metric</b>	
<b>Steel</b>	
Part No	
MFSS-4-45	1/4BSP Male X M12x1.5 Female - Swivel
MFSS-4-55	1/4BSP Male X M14x1.5 Female - Swivel
MFSS-4-85	1/4BSP Male X M18x1.5 Female - Swivel
MFSS-55-4	M14x1.5 Male X 1/4BSP Female - Swivel
MFSS-6-105K	3/8BSP Male X M22 Karcher Female - Swivel
MFSS-6-115	3/8BSP Male X M22x1.5 Female - Swivel
MFSS-6-31	3/8BSP Male X M10x1.0 Female - Swivel
MFSS-8-105	1/2BSP Male X M22x1.5 Female - Swivel
MFSS-8-125	1/2BSP Male X M26x1.5 Female - Swivel
MFSS-8-85	1/2BSP Male X M18x1.5 Female - Swivel
MFSS-85-8	M18x1.5 Male X 1/2BSP Female - Swivel

<b>Various</b>	
<b>Aluminium</b>	
Part No	
MFA8-3	-3JIC X 1/8NPTF Female - Non Swivel

<b>Steel</b>	
Part No	
FBM2719	-3JIC Male X 1/8NPTF Female - Non Swivel
MFS9-3-7	5/8UNF Mle X 1/8BSP Fml - Remote Filter Pressure T/O
MFS13-3X-31	M10x1 MI X 3/8UNF Fml Concave Seat - Caliper Converter
MFS9-6-7	3/8BSP Male X 5/8UNF Female - Gauge
MFS9-7-3	5/8UNF Male X 1/8NPTF Female

## Male To Female 45° & 90° Adapter



<b>JIC To JIC</b>	
<b>Aluminium</b>	
Part No	
FBM3148	-6JIC Swivel 45° Aeroquip Blue
FBM3149	-8JIC Swivel 45° Aeroquip Blue
FBM3150	-10JIC Swivel 45° Aeroquip Blue
FBM3151	-12JIC Swivel 45° Aeroquip Blue
FBM3155	-6JIC Swivel 90° Aeroquip Blue
FBM3156	-8JIC Swivel 90° Aeroquip Blue
FBM3157	-10JIC Swivel 90° Aeroquip Blue
FBM3158	-12JIC Swivel 90° Aeroquip Blue

<b>Steel</b>	
Part No	
MFS97-6	-6JIC Swivel 90°
MFS97-8	-8JIC Swivel 90°
MFS97-10	-10JIC Swivel 90°

Continue On Next Page

### NPTF To NPTF

#### Aluminium

##### Part No

FBM2147	1/8NPTF Non Swivel 90°
FBM2148	1/4NPTF Non Swivel 90°
FBM2149	3/8NPTF Non Swivel 90°

### JIC To NPTF

#### Aluminium

##### Part No

MFA98-3-3	-3JIC X 1/8NPTF Non Swivel 90°
-----------	--------------------------------

### BSP To BSP

#### Steel

##### Part No

MFS43-8	1/2BSP Swivel 45°
MFS43-10	5/8 BSP Swivel 45°
MFS93-3	1/8BSP Swivel 90°
MFS93-4	1/4BSP Swivel 90°
MFS93-6	3/8BSP Swivel 90°
MFS93-8	1/2 BSP Swivel 90°
MFS93-10	5/8 BSP Swivel 90°

## Male To Male 45° Adapter



### JIC To NPTF (AN823)

#### Aluminium

##### Part No

FBM2020	-3JIC X 1/8NPTF Aeroquip Blue
FBM2021	-4JIC X 1/8NPTF Aeroquip Blue
FBM2022	-6JIC X 1/4NPTF Aeroquip Blue
FBM2023	-8JIC X 3/8NPTF Aeroquip Blue
FBM2024	-10JIC X 1/2NPTF Aeroquip Blue
FBM2025	-12JIC X 3/4NPTF Aeroquip Blue
FBM2026	-16JIC X 1"NPTF Aeroquip Blue
FBM5020	-3JIC X 1/8NPT Aeroquip Black
FBM5021	-4JIC X 1/8NPT Aeroquip Black
FBM5022	-6JIC X 1/4NPT Aeroquip Black
FBM5023	-8JIC X 3/8NPT Aeroquip Black
FBM5024	-10JIC X 1/2NPT Aeroquip Black
FBM5025	-12JIC X 3/4NPT Aeroquip Black

#### Steel

##### Part No

AN823-3C	-3JIC X 1/8NPTF, Stainless Steel
FBM2586	-6JIC X 1/4NPTF
FBM2589	-6JIC X 3/8NPTF
FBM2593	-8JIC X 1/2NPTF
FBM2594	-10JIC X 1/2NPTF
FBM2595	-12JIC X 1/2NPTF

### JIC To UNF

#### Steel

##### Part No

2061-10-10S	-10JIC X 7/8SAE O Ring(UNF)
-------------	-----------------------------

## Male To Male 90° Adapter



### JIC To NPTF (AN822)

#### Aluminium Forged

##### Part No

FBM2030	-3JIC X 1/8NPTF Aeroquip Blue
FBM2031	-4JIC X 1/8NPTF Aeroquip Blue
FBM2032	-4JIC X 1/4NPTF Aeroquip Blue
FBM2033	-6JIC X 1/8NPTF Aeroquip Blue
FBM2034	-6JIC X 1/4NPTF Aeroquip Blue
FBM2035	-6JIC X 3/8NPTF Aeroquip Blue
FBM2036	-8JIC X 1/4NPTF Aeroquip Blue
FBM2037	-8JIC X 3/8NPTF Aeroquip Blue
FBM2038	-8JIC X 1/2NPTF Aeroquip Blue
FBM2039	-10JIC X 1/2NPTF Aeroquip Blue
FBM2040	-12JIC X 3/4NPTF Aeroquip Blue
FBM2041	-16JIC X 1"NPTF Aeroquip Blue

FBM5030	-3JIC X 1/8NPT Aeroquip Black
FBM5031	-4JIC X 1/8NPT Aeroquip Black
FBM5032	-4JIC X 1/4NPT Aeroquip Black
FBM5033	-6JIC X 1/8NPT Aeroquip Black
FBM5034	-6JIC X 1/4NPT Aeroquip Black
FBM5035	-6JIC X 3/8NPT Aeroquip Black
FBM5036	-8JIC X 1/4NPT Aeroquip Black
FBM5037	-8JIC X 3/8NPT Aeroquip Black
FBM5038	-8JIC X 1/2NPT Aeroquip Black
FBM5016	-10JIC X 3/8NPT Aeroquip Black
FBM5039	-10JIC X 1/2NPT Aeroquip Black
FBM5017	-12JIC X 1/2NPT Aeroquip Black

### Aluminium Swept Compact

#### Part No

MMA98-6	-6JIC X 3/8NPTF
MMA98-8-4	-8JIC X 1/4NPTF
MMA98-8-6	-8JIC X 3/8NPTF
MMA98-8	-8JIC X 1/2NPTF
MMA98-10-6	-10JIC X 3/8NPTF
MMA98-10-8	-10JIC X 1/2NPTF
MMA98-10-12	-10JIC X 3/4NPTF
MMA98-12-8	-12JIC X 1/2NPTF
MMA98-16	-16JIC X 1 NPTF

#### Steel

##### Part No

FBM2610	-3JIC X 1/8NPTF
FBM2611	-4JIC X 1/8NPTF
FBM2616	-6JIC X 1/4NPTF
FBM2620	-6JIC X 3/8NPTF
FBM2617	-8JIC X 1/4NPTF
FBM2626	-8JIC X 1/2NPTF
FBM2627	-10JIC X 1/2NPTF
FBM2628	-12JIC X 1/2NPTF
FBM2631	-12JIC X 3/4NPTF

### JIC To UNF

#### Steel

##### Part No

2062-10-10S	-10JIC X 7/8SAE O Ring(UNF)
2062-10-12S	-12JIC X 7/8SAE O Ring(UNF)

### JIC To JIC (AN821)

#### Aluminium Forged

##### Part No

FBM2186	-3JIC Aeroquip Blue
FBM2119	-4JIC Aeroquip Blue
FBM2120	-6JIC Aeroquip Blue
FBM2190	-8JIC Aeroquip Blue
AN821-10	-10JIC Aeroquip Blue
FBM2191	-12JIC Aeroquip Blue

## Male To Male To Male T Adapter



### JIC To JIC To JIC (AN824)

#### Aluminium

##### Part No

FBM2060	-3JIC Aeroquip Blue
FBM2061	-4JIC Aeroquip Blue
FBM2062	-6JIC Aeroquip Blue
FBM2063	-8JIC Aeroquip Blue
FBM2064	-10JIC Aeroquip Blue
FBM2065	-12JIC Aeroquip Blue
FBM2066	-16JIC Aeroquip Blue

### Steel Unless Stated Otherwise

##### Part No

MTS7-3	-3JIC Male Stainless With 5mm Fixing Hole
MTS7-3	-3JIC Male
MTS7-4	-4JIC Male
MTS7-6	-6JIC Male
MTS7-8	-8JIC Male
MTS7-10	-10JIC Male
MTB3-3	1/8BSP Male Brass
MTS3-3	1/8BSP Male
MTS3-4	1/4BSP Male
MTS3-6	3/8BSP Male
MTS3-8	1/2BSP Male
MTS3-10	5/8BSP Male

## Branch T (AN825) Adapter



### JIC To JIC To NPTF

#### Aluminium

##### Part No

FBM2187	-3JIC X -3JIC X 1/8NPTF Aeroquip Blue
FBM2121	-4JIC X -4JIC X 1/8NPTF Aeroquip Blue
FBM2122	-6JIC X -6JIC X 1/4NPTF Aeroquip Blue
FBM2123	-8JIC X -8JIC X 3/8NPTF Aeroquip Blue

## Running T (AN826) Adapter



### JIC To NPTF To JIC

#### Aluminium

##### Part No

FBM2714	-3JIC X 1/8NPTF X -3JIC Aeroquip Blue
FBM2124	-4JIC X 1/4NPTF X -4JIC Aeroquip Blue
FBM2125	-6JIC X 1/4NPTF X -6JIC Aeroquip Blue
FBM2126	-8JIC X 3/8NPTF X -8JIC Aeroquip Blue

## Male To Female To Male Branch T Adapter



### JIC To JIC To JIC

#### Aluminium

##### Part No

925103	-3JIC
925104	-4JIC
925106	-6JIC
925108	-8JIC
925110	-10JIC
925112	-12JIC
925116	-16JIC

## Female To Male To Male Running T Adapter



### JIC To JIC To JIC

#### Aluminium

##### Part No

926103	-3JIC
926104	-4JIC
926106	-6JIC
926108	-8JIC
926110	-10JIC
926116	-12JIC

## Male To Female To Male Branch Y Adapter



### JIC To JIC To JIC

#### Aluminium

##### Part No

MMFY-6-6-8	-6JIC Males X -8JIC Female
MMFY-6	-6JIC Males/ -6 JIC Female
MMFY-8	-8JIC Males/ -8JIC Female
MMFY-10	-10JIC Males/ -10JIC Female
MMFY-12	-12JIC Males/ -12JIC Female

## Female To Female Adapter



### JIC To JIC - Swivel

#### Aluminium

##### Part No

FBM2914	-4JIC Straight Aeroquip Blue
FBM2915	-6JIC Straight Aeroquip Blue
FBM2916	-8JIC Straight Aeroquip Blue
FBM2917	-10JIC Straight Aeroquip Blue
FBM2918	-12JIC Straight Aeroquip Blue
FBM2971	-6JIC 45° Aeroquip Blue
FBM2972	-8JIC 45° Aeroquip Blue
FBM2973	-10JIC 45° Aeroquip Blue
FBM2974	-12JIC 45° Aeroquip Blue
FBM2978	-6JIC 90° Aeroquip Blue
FBM2979	-8JIC 90° Aeroquip Blue
FFA97-10	-10JIC 90° Aeroquip Blue
FBM2981	-12JIC 90° Aeroquip Blue
FBM2982	-16JIC 90° Aeroquip Blue

#### Steel

##### Part No

FFS7-4	-4JIC Straight
FFS7-6	-6JIC Straight

### NPTF To NPTF - Non Swivel (AN910)

#### Aluminium

##### Part No

FBM2129	1/8NPTF Straight Aeroquip Blue
FBM2130	1/4NPTF Straight Aeroquip Blue
FBM2131	3/8NPTF Straight Aeroquip Blue

### BSP To BSP - Swivel Straight

#### Steel

##### Part No

FFS3-3	1/8BSPx1/8BSP Straight
FFS3-3-4	1/8BSPx1/4BSP Straight
FFS3-4	1/4BSPx1/4BSP Straight
FFS3-4-6	1/4BSPx3/8BSP Straight
FFS3-6	3/8BSPx3/8BSP Straight
FFS3-8	1/2BSPx1/2BSP Straight
FFS3-10	5/8BSPx5/8BSP Straight

## Female To Female To Female T Adapter



Brass T on right Intended for use on rigid brake lines, but can be used with flexible hose using suitable adapters. Ports have 45° concave sealing face to take flared pipe and male tube nut.

### JIC To JIC To JIC

#### Aluminium

##### Part No

FBM2173	-4JIC Aeroquip Blue
FBM2174	-6JIC Aeroquip Blue
FBM2175	-8JIC Aeroquip Blue
FBM2176	-10JIC Aeroquip Blue
FBM2177	-12JIC Aeroquip Blue

### NPTF To NPTF To NPTF (AN917)

#### Aluminium

##### Part No

FBM2150	1/8NPTF Aeroquip Blue
FBM2151	1/4NPTF Aeroquip Blue
FBM2152	3/8NPTF Aeroquip Blue
AN917-8	1/2NPTF

### UNF/Metric Port With 45° Seat

#### Brass

##### Part No

FT1-3	3/8UNF Female With 5/16in Fixing Hole
FT2-31	M10x1 Female With 5/16in Fixing Hole

## Female To Female To Female To Female X Adapters



As previously described for female to female to female T adapter.

### NPTF

#### Aluminium

##### Part No

AN918-4 1/4NPTF

### UNF/Metric Port With 45° Seat

#### Brass

##### Part No

FCB1-3 3/8UNF Female With 5/16in Fixing Hole

FCB2-31 M10x1 Female With 5/16in Fixing Hole

## Banjo Adaptors -6 Upwards (Fuel & Oil)

### Banjo To Metric Female At 90° To Bore



Use of this part makes for a neater installation when using banjo fittings, page 36, in multiple Weber, Dellorto & Solex sidedraft installations. Designed to take original banjo bolt.

#### Aluminium

##### Part No

BA2-45 M12 ID To M12x1.50 - Weber

BA2-42 M12 ID To M12x1.25 - Dellorto

BAR2-7 Adapter Ring Dellorto Down Draft With M7 Bolt

### Banjo To JIC Male At 90° Bore (AN776)



#### Aluminium

##### Part No

BA7-M12-6 12mm ID X -6JIC

BA7-M12-6L 12mm ID X -6JIC Extended Neck

BA7-M14-6 14mm ID X -6JIC

BA7-M14-6L 14mm ID X -6JIC Extended Neck

BA7-M16-6 16mm ID X -6JIC

BA7-M18-6 18mm ID X -6JIC

BA7-M12-8 12mm ID X -8JIC

BA7-M14-8 14mm ID X -8JIC

BA7-M16-8 16mm ID X -8JIC

BA7-M18-10 18mm ID X -10JIC

BA7-M20-10 20mm ID X -10JIC

BA7-M22-8 22mm ID X -8JIC

BA7-M22-10 22mm ID X -10JIC

### Banjo To Double JIC Male At 90° To Bore (AN778)



#### Aluminium

##### Part No

BAD7-8 3/4in ID X -8JIC

BAD7-10 7/8in ID X -10JIC

BAD7-M12-6 12mm ID X -6JIC

BAD7-M14-6 14mm ID X -6JIC

## Bolts (AN775) For Oil & Fuel Banjos



#### Aluminium

##### Part No

BBA3-4 1/4BSP

BBA3-6 3/8BSP

BBA3-8 1/2BSP

BBA1-6 9/16UNF

BBA1-8 3/4UNF

BBA1-10 7/8UNF

BBA2-45 M12x1.5 Replaces Weber Steel Bolt

BBA2-55 M14x1.5

BBA2-65 M16x1.5

BBA2-85 M18x1.5

BBA2-95 M20x1.5

BBA2-105 M22x1.5

#### Steel

##### Part No

BBS2-21A M8x1.0

BBS2-31A M10x1.0

BBS2-35 M10x1.5

BBS2-45 M12x1.5

BBS2-55 M14x1.5

BBS2-65 M16x1.5

BBS2-85 M18x1.5

## Banjo Adaptors -3 & -4 (Brake & Clutch)

### Single Male



Takes long banjo bolts, see page 61, & page 70 for washers.

#### Aluminium

##### Part No

BA7-M10-3 -3JIC Male Takes 3/8UNF / M10 / 1/8BSP Bolt

BA7-M12-3 -3JIC Male Takes M12 Bolt

BA7-M10-4 -4JIC Male Takes 3/8UNF / M10 / 1/8BSP Bolt

BA7-M12-4 -4JIC Male Takes M12 Bolt

BA7-4 -4JIC Male Takes 7/16UNF Bolt

#### Steel

##### Part No

BMS3-3 1/8BSP Male Takes 3/8UNF / M10 / 1/8BSP Bolt

BMS7-3 -3JIC Male Takes 3/8UNF / M10 / 1/8BSP Bolt, Stainless

FBM2938 -4JIC Male Takes 3/8UNF / M10 / 1/8BSP Bolt

BMS7-4 -4JIC Male Takes 7/16UNF / M12 Bolt, Stainless

### Double Male



Takes long banjo bolts, see page 61, & page 70 for washers.

#### Aluminium

##### Part No

BAD7-M10-3 -3JIC Male Takes 3/8UNF / M10/1/8BSP Bolt

BAD7-M10-4 -4JIC Male Takes 3/8 / M10 / 1/8BSP Bolt

BAD7-M12-4 -4JIC Male Takes M12 Bolt

BAD7-4 -4JIC Takes 7/16UNF Bolt

BAD7-M14-4 -4JIC Takes M14 Bolt

#### Steel

##### Part No

BMSD3-3 1/8BSP Males Takes 3/8UNF / M10 / 1/8BSP Bolt

BMSD7-3 -3JIC Male Takes 3/8UNF / M10 / 1/8BSP Bolt

BMSD7-3 -3JIC Male Takes As Above - Stainless

## Bolts For Brake & Clutch Banjos

### Short Bolts, 20mm Under Hex



#### Steel

Part No	
BBS1-2	5/16UNF
BBS1-3	3/8UNF
BBS1-3	3/8UNF Stainless
BBS1-4FR	7/16UNF X 24 TPI Restricted
BBS1-5	1/2UNF
BBS1A-2	5/16UNC
BBS14-3	3/8UNC
BBS3-3	1/8BSP
BBS2-21	M8x1.0
BBS2-22	M8x1.25
BBS2-31	M10x1
BBS2-31	M10x1, Stainless
BBS2-32	M10x1.25
BBS2-32	M10x1.25, Stainless
BBS2-35	M10x1.5
BBS2-41	M12x1.0

#### Aluminium

Part No	
BBA1-3	3/8UNF
BBA2-31	M10x1
BBA2-32	M10x1.25
BBA2-41	M12x1

### Double Short Bolts, 30mm Under Hex



#### Steel

Part No	
BBSD1-3	3/8UNF
BBSD2-31	M10x1.0
BBSD2-32	M10x1.25
BBSD2-45	M12x1.5

#### Aluminium

Part No	
BBAD1-3	3/8UNF
BBAD2-31	M10x1
BBAD2-32	M10x1.25

### Long Bolts, 25mm Under Hex



#### Steel

Part No	
BBSL1-3	3/8UNF
BBSL-3	3/8UNF, Stainless
BBSL1-4	7/16UNF
BBSL12-4	7/16X24TPI
BBSL2-31	M10x1
BBSL2-32	M10x1.25
BBSL2-41	M12x1.0

#### Aluminium

Part No	
BBAL1-3	3/8UNF
BBAL2-31	M10x1
BBAL2-32	M10x1.25

#### Brake Light Switch Banjo Bolt, Stainless Steel

Part No	
BLSBBS1-3	Brake Light Switch Banjo Bolt 3/8UNF S/S
BLSBBS2-31	Brake Light Switch Banjo Bolt M10x1.0 S/S
BLSBBS2-32	Brake Light Switch Banjo Bolt M10x1.25 S/S

## Double Long Bolts, 39mm Under Hex



#### Steel

Part No	
BBSLD1-3	3/8UNF
BBSSLD1-3	3/8UNF, Stainless
BBSLD2-31	M10x1.0
BBSDL2-32	M10x1.25
BBSLD3-3	1/8BSP

#### Washers For Banjo Bolts

#### Steel

Part No	
WC-3/8	Folded Copper 3/8 & 1/8BSP
WC-M10	Folded Copper 10mm
WC7/16	Folded Copper 7/16
WC-M12	Folded Copper 12mm

## Aluminium Fuel Blocks



With 1/8NPTF tapping for fuel pressure gauge /switch.

#### Aluminium

Part No	
FBM2178	1/4NPTF Out - 3/8NPTF In
FBM2179	3/8NPTF Out - 1/2NPTF In

## Fuel/Oil Pressure Adapters

### Male to male



With 1/8NPTF tapping for fuel or oil pressure gauge/switch.

#### Aluminium

Part No	
FBM2183	-6JIC Straight
FBM2184	-8JIC Straight
FBM2272	-6JIC 90°
FBM2273	-8JIC 90°
FBM2274	-10JIC 90°

#### Stainless Steel

Part No	
HARS	-3JIC

### Male To Female To Female Straight

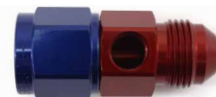

With 1/8NPTF tapping for fuel or oil pressure gauge/switch.

#### Aluminium

Part No	
MFFS8-4-4-3	-4JIC Male, 1/8NPT Female, -4JIC Female
MFFA8-6-6-3	-6JIC Male, 1/8NPT Female, -6JIC Female
MFFA8-6-6-3BK	-6JIC Male, 1/8NPT Female, -6JIC Female, Black
MFFA8-8-8-3	-8JIC Male, 1/8NPT Female, -8JIC Female
MFFA8-10-10-3	-10JIC Male, 1/8NPT Female, -10JIC Female
MFFA8-12-12-3	-12JIC Male, 1/8NPT Female, -12JIC Female

#### Steel

Part No	
MFFS8-3-3-3	-3JIC Male, 1/8NPT Female, -3JIC Female, Stainless
MFFS3-8-8-3	1/2BSP Male, 1/2BSP Female, 1/8BSP Female



## Bulkhead Adapters

Replace 2 with 5 for black, e.g. FBM2769 becomes FBM5769

### Male To Male Straight (AN832)



#### Aluminium

Part No	
FBM2769	-3JIC Aeroquip Blue
FBM2071	-4JIC Aeroquip Blue
FBM2072	-6JIC Aeroquip Blue
FBM2073	-8JIC Aeroquip Blue
FBM2074	-10JIC Aeroquip Blue
FBM2075	-12JIC Aeroquip Blue
FBM2076	-16JIC Aeroquip Blue
AN832-20	-20JIC Blue

#### Steel

Part No	
MMSB3-3	1/8BSP
MMSB3-4	1/4BSP
MMSB3-6	3/8BSP
MMSB3-8	1/2BSP Incl. Nuts
MMSB3-10	5/8BSP Incl. Nuts
MMSB2-31-31	M10x1
MMSB7-3	-3JIC
MMSB2-3	-3JIC, Stainless
MMSB7-4	-4JIC
FBM2772	-4JIC X -6JIC
FBM2774	-6JIC
FBM2775	-8JIC

### Male To Male Bulkhead, Unequal

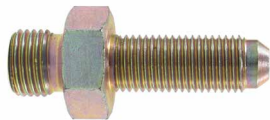

BSP or JIC female to metal brake pipe having female tube nuts

#### Steel

Part No	
MMSB9-3	1/8BSP X 3/8UNF
MMSB5-3-31	1/8BSP X M10x1.0
MMSB5-3-32	1/8BSP X M10x1.25
MMSB9-4	1/4BSP X 7/16UNF
MMSB1-3	-3JIC X 3/8UNF, Stainless

### Male To Male 45° (AN837)



#### Aluminium

Part No	
FBM2893	-3JIC Aeroquip Blue
FBM2127	-4JIC Aeroquip Blue
FBM2128	-6JIC Aeroquip Blue

#### Steel

Part No	
MMSB4-3	-3JIC- Stainless

### Male To Male 90° (AN833)



#### Aluminium

Part No	
FBM2799	-3JIC Aeroquip Blue
FBM2081	-4JIC Aeroquip Blue
FBM2082	-6JIC Aeroquip Blue
FBM2083	-8JIC Aeroquip Blue

FBM2084	-10JIC Aeroquip Blue
FBM2085	-12JIC Aeroquip Blue
FBM2086	-16JIC Aeroquip Blue

#### Steel

Part No	
FBM2790	-3JIC, Incl. Nut
MMSSB9-3	-3JIC, Stainless
FBM2793	-6JIC, Incl. Nut

### Male To Male To Male Branch T (AN834)



#### Aluminium

Part No	
FBM2808	-3JIC Aeroquip Blue
FBM2091	-4JIC Aeroquip Blue
FBM2092	-6JIC Aeroquip Blue
FBM2093	-8JIC Aeroquip Blue
AN834-10	-10JIC Blue
AN834-12	-12JIC Blue
AN834-16	-16JIC Blue

#### Steel

Part No	
MBT57-3	-3JIC
MBT557-3	-3JIC, Stainless

### Male To Male To Male Running T (AN804)



#### Aluminium

Part No	
FBM2815	-3JIC Aeroquip Blue
FBM2117	-4JIC Aeroquip Blue
FBM2118	-6JIC Aeroquip Blue
FBM2180	-8JIC Aeroquip Blue

#### Steel

Part No	
FBM2809	-3JIC, Incl. Nut
MBR557-3	-3JIC, Stainless

### Bulkhead Locknuts (AN6289)

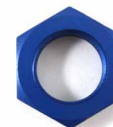

#### Aluminium

Part No	
BNA3-3	1/8BSP
FBM3556	-3JIC & 3/8UNF Aeroquip Blue
FBM2099	-4JIC & 7/16UNF Aeroquip Blue
FBM2100	-6JIC & 9/16UNF Aeroquip Blue
FBM2103	-8JIC & 3/4UNF Aeroquip Blue
FBM2104	-10JIC & 7/8UNF Aeroquip Blue
FBM2105	-12JIC Aeroquip Blue
FBM2106	-16JIC Aeroquip Blue
AN924-20	-20JIC Blue

#### Steel

Part No	
BNS3-3	1/8BSP
BNS3-4	1/4BSP
BNS1-3	-3JIC & 3/8UNF
BNS1-4	-4JIC & 7/16UNF
BNS1-6	-6JIC & 9/16UNF
BNS1-8	-8JIC & 3/4UNF
BNS2-31	M10x1.0
BNS2-41	M12x1
BNS5/8W	5/8WHITx26TPI
BNS51-3	-3JIC & 3/8UNF Stainless
WSP-3/8	Washer - Shake Proof For -3JIC & 3/8UNF
WSP-M10	Washer - Shake Proof For M10
WSP-5/8	Washer - Shake Proof For 5/8Whit

## Bulkhead Hose Adapter



These adapters offer a neat solution to pass fluids through a bulkhead or panel. CNC machined from billet aluminium.

Part No	
HEAB14-M13	1/2" - 1/2" Bulkhead Hose Adapter - Narrow Spacing
HEAB14-M13W	1/2" - 1/2" Bulkhead Hose Adapter - Wide Spacing
HEAB14-M13-M16	1/2" - 5/8" Bulkhead Hose Adapter - Narrow Spacing
HEAB14-M13-M16W	1/2" - 5/8" Bulkhead Hose Adapter - Wide Spacing
HEAB7-10-M13	1/2" - AN10 Bulkhead Adapter - Narrow Spacing
HEAB7-10-M13W	1/2" - AN10 Bulkhead Adapter - Wide Spacing

## Blanking Plugs

### JIC (AN806)



Aluminium	
Part No	
AN806-1	1/4UNF Blue
AN806-2	-2JIC Blue
FBM3712	-3JIC Aeroquip Blue
FBM3713	-4JIC Aeroquip Blue
FBM3714	-6JIC Aeroquip Blue
FBM3715	-8JIC Aeroquip Blue
FBM3716	-10JIC Aeroquip Blue
FBM3717	-12JIC Aeroquip Blue
FBM3718	-16JIC Aeroquip Blue
AN806-20	-20JIC Blue
AN806-24D	-24JIC Blue
Steel	
Part No	
FBM3701	-3JIC
BPS7-4	-4JIC
BPS7-6	-6JIC
BPS7-8	-8JIC
BPS7-10	-10JIC
BPS7-12	-12JIC
BPS7-16	-16JIC
BPS7-20	-20JIC

### UNF With O Ring Seal (AN814)



Aluminium	
Part No	
BPA1-5/16	5/16UNF, O Ring Not Supplied
FBM3722	3/8UNF Aeroquip Blue
BPA1-5	1/2UNF, O Ring Not Supplied
FBM3723	7/16UNF Aeroquip Blue
FBM3724	9/16UNF Aeroquip Blue
BPA1-7	5/8UNF, O Ring Not Supplied
FBM3725	3/4UNF Aeroquip Blue
FBM3726	7/8UNF Aeroquip Blue
FBM3727	1+1/6UNF Aeroquip Blue

## BSP



Aluminium	
Part No	
BPA3-3	1/8BSP
BPA3-4	1/4BSP
BPA3-6	3/8BSP
BPA3-8	1/2BSP
BPA3-12	3/4BSP
Steel	
Part No	
BPS3-3	1/8BSP
BPS3-4	1/4BSP
BPS3-6	3/8BSP
BPS3-8	1/2BSP
BPS3-10	5/8BSP
BPS3-12	3/4BSP

## Metric



Aluminium	
Part No	
BPA2-11	M6x1.0
BPA2-21	M8x1.0
BPA2-31	M10x1.0
BPA2-41	M12x1.0
BPA2-45	M12x1.5
BPA2-55	M14x1.5
BPA2-65	M16x1.5
BPA2-85	M18x1.5
BPA2-95	M20x1.5
BPA2-105	M22x1.5
BPA2-115	M24x1.5
BPA2-125	M26x1.5
BPA2-165	M30x1.5
Socket Head	
BPA2-41SH	Alloy Plug M12x1.0 Socket Head
BPA2-45SH	Alloy Plug M12x1.5 Socket Head
BPA2-55SH	Alloy Plug M14x1.5 Socket Head
BPA2-65SH	Alloy Plug M16x1.5 Socket Head
BPA2-95SH	Alloy Plug M20x1.5 Socket Head
BPA2-105SH	Alloy Plug M22x1.5 Socket Head

### NPTF Socket Head (AN932)



Aluminium	
Part No	
FBM3684	1/16NPTF Aeroquip Blue
FBM3685	1/8NPTF Aeroquip Blue
FBM3686	1/4NPTF Aeroquip Blue
FBM3687	3/8NPTF Aeroquip Blue
FBM3749	1/2NPTF Aeroquip Blue
FBM3750	3/4NPTF Aeroquip Blue
Steel	
Part No	
BPSHS8-2	1/16NPTF Black
BPSHS8-3	1/8NPTF Black
BPSHS8-4	1/4NPTF Black

## NPTF Hexagon Head



### Steel

Part No	
BPS8-3	1/8NPTF
BPS8-4	1/4NPTF
BPS8-6	3/8NPTF
BPS8-8	1/2NPTF

## Blanking Caps (AN929)

### JIC, Swivel



### Aluminium

Part No	
BCA7-2	-2JIC Blue
FBM3751	-3JIC Aeroquip Blue
FBM3752	-4JIC Aeroquip Blue
FBM3740	-6JIC Aeroquip Blue
FBM3741	-8JIC Aeroquip Blue
FBM3742	-10JIC Aeroquip Blue
FBM3743	-12JIC Aeroquip Blue
FBM3744	-16JIC Aeroquip Blue

### Steel

Part No	
BCS7-20	-20JIC
BCS7-24	-24JIC

## BSP/JIC, Non Swivel



### Steel

Part No	
BCS3-3	1/8BSP
BCS3-4	1/4BSP
BCS3-6	3/8BSP
BCS3-8	1/2BSP
BCS3-10	5/8BSP
BCS3-12	3/4BSP
FBM3479	-3JIC
FBM3480	-4JIC
FBM3602	-6JIC
FBM3603	-8JIC
FBM3604	-10JIC
FBM3605	-12JIC
FBM3566	-16JIC

## Metric



### Aluminium

Part No	
BCA2-45	M12x1.5 Swivel
BCA2-45B	M12x1.5 Fixed For Bosch Pump
BCA2-55	M14x1.5 Swivel
BCA2-65	M16x1.5 Swivel
BCA2-85	M18x1.5 Swivel
BCA2-105	M22x1.5 Swivel
BCA2-125	M26x1.5 Swivel
BCA2-165	M30x1.5 Swivel

## Weld On Connections

### Weld On Push On



### Aluminium

Part No	
WO15-6	3/8" Push On
WO14-8	1/2" Push On
WO15-12	3/4" Push On

### Weld On BSP



### Aluminium

Part No	
WO3-3	1/8 BSP Male
WO3-4	1/4 BSP Male
WO3-6	3/8 BSP Male
WO3-8	1/2 BSP Male
WO3-10	5/8 BSP Male
WO3-12	3/4 BSP Male
WO3-16	1 BSP Male

### Weld On JIC



### Aluminium

Part No	
WO7-3	-3JIC Male
WO7-4	-4JIC Male
WO7-6	-6JIC Male
WO7-8	-8JIC Male
WO7-10	-10JIC Male
WO7-12	-12JIC Male
WO7-16	-16JIC Male
WOF7-6	-6JIC Female
FBM2403	-6JIC Female
FBM2404	-8JIC Female
FBM2405	-10JIC Female
FBM2406	-12JIC Female
FBM2407	-16JIC Female

### Steel

Part No	
WOS7-3	-3JIC Male
WOS7-4	-4JIC Male
WOS7-6	-6JIC Male
WOS7-8	-8JIC Male
WOS7-10	-10JIC Male
WOS7-12	-12JIC Male
WOS7-16	-16JIC Male

## Weld On Metric



### Aluminium

Part No	
WO2-M14	M14x1.5 Male
WO2-M16	M16x1.5 Male
WO2-M18	M16x1.5 Male
WO2-M22	M22x1.5 Male
WO2-M26	M26x1.5 Male
WO2-M30	M30x1.5 Male
WOF2-21	M8x1.0 Female
WOF2-31	M10x1.0 Female
WOF2-M12	M12x1.5 Female
WOF2-M14	M14x1.5 Female
WOF2-M16	M16x1.5 Female
WOF2-M18	M18x1.5 Female
WOF2-M22	M22x1.5 Female

### Steel

Part No	
WOF52-85	M18x1.5
WOF52-85	M18x1.5, Stainless

## Weld On NPTF

### Aluminium

Part No	
WO8-8	1/2 NPTF Female
WO8-3	1/8 NPTF Female

## Weld On Boss For EFI Fuel Injectors



Bosses to take common Bosch or similar injectors that use a 9/16" or 14mm O.D. O-ring.

### For EFI Fuel Injectors

Part No	
WIB1	Weld On Boss To Suit EFI Fuel Injectors

## EFI Adapters



A range of EFI fittings to convert standard OEM fuel rails, tanks or fuel lines to a JIC thread.

Part No	
PEM7-6-5GM	-6JIC Male For 5/16 OD EFI Tube
PEM7-6-6GM	-6JIC Male For 3/8 OD EFI Tube
PEM7-6-8GM	-6JIC Male For 1/2 OD EFI Tube
PEM7-8-6GM	-8JIC Male For 3/8 OD EFI Tube
PEM7-8-8GM	-8JIC Male For 1/2 OD EFI Tube

## Aluminium Caps & Plugs



Made by Aeroquip. Reusable solid protection for threads provide airtight, moisture and dust proof seal.

### Caps

Part No	
FBM3647	-3JIC - 3/8UNF
FBM3648	-4JIC - 7/16UNF
FBM3649	-6JIC - 9/16UNF
FBM3650	-8JIC - 3/4UNF
FBM3651	-10JIC - 7/8UNF
FBM3652	-12JIC - 1/16UNF
FBM3653	-16JIC - 1+5/16UNF

### Plugs

Part No	
FBM3654	-3JIC - 3/8UNF
FBM3655	-4JIC - 7/16UNF
FBM3656	-6JIC - 9/16UNF
FBM3657	-8JIC - 3/4UNF
FBM3658	-10JIC - 7/8UNF
FBM3659	-12JIC - 1+1/16UNF
FBM3660	-16JIC - 1+5/16UNF

## Red Caps & Plugs



Plastic protectors for temporary sealing of ports, popular items are listed, others available.

### Caps

Part No	
RC3-3	1/8BSP
RC3-4	1/4BSP
RC3-6	3/8BSP
RC3-8	1/2BSP
RC3-10	5/8BSP
RC3-12	3/4BSP
RC3-16	1InBSP
RC7-3	-3JIC
RC7-4	-4JIC
RC7-6	-6JIC
RC7-8	-8JIC
RC7-10	-10JIC
RC7-12	-12JIC
RC7-16	-16JIC

### Plugs

Part No	
RP3-3	1/8BSP
RP3-4	1/4BSP
RP3-6	3/8BSP
RP3-8	1/2BSP
RP3-10	5/8BSP
RP3-12	3/4BSP
RP7-3	-3JIC / 3/8UNF
RP7-4	-4JIC / 7/16UNF
RP7-6	-6JIC / 9/16UNF
RP7-8	-8JIC / 3/4UNF
RP7-10	-10JIC / 7/8UNF
RP7-12	-12JIC / 11/16 UNF
RP7-16	-16JIC / 15/16 UNF

### Tapered Unthreaded Bungs

Part No	
RB-M8	06.9-8.2.0 ID / 8.4-10 OD
RB-M10	08.5-10.0 ID / 10-11.3 OD
RB-M15	16.4-18.3 ID / 17.8-20.0 OD
RB-M18	17.6-21.0 ID / 19.0-21.5 OD
RB-M27	24.7-27.9 ID / 26.9-28.7 OD
RB-M31	28.4-31.1 ID / 30.5-33.3 OD
RB-M39	37.1-39.0 ID / 38.6-40.6 OD
RB-M41	37.7-41.8 ID / 40.8-44.7 OD
RB-M43	42.0-47.0 ID / 43.4-48.5 OD
RB-M46	44.3-48.0 ID / 46.0-50.0 OD
RB-M51	49.6-52.0 ID / 51.8-54.1 OD
RB-M60	57.5-65.4 ID / 59.7-67.3 OD
RB-M74	70.0-73.4 ID / 74.0-76.8 OD
RB-M77	74.8-78.2 ID / 77.1-80.7 OD
RB-M80	77.5-82.0 ID / 80.0-86.1 OD
RB-M84	80.0-88.3 ID / 84.0-90.8 OD

## Jiffy-tite™ Quick Connect Fluid Fittings

Three series of assemblies to suit flow conditions, each size available in a number of threads types and sizes. Available with or without dry-break/self-sealing valves. Fittings of the same series can be connected to different thread / hose sizes to provide step up or down. Made in the USA. Constructed with 6061-T6 aluminium bodies, anodized gold and black, stainless steel ball bearings, the valves are brass. They are lightweight, compact and very easily connected and disconnected by hand. Seals are fluorocarbon, Buna N (nitrile) to special order. Suitable for all oil, water and fuel (Use nitrile seals for alcohol & methanol) at pressures up to 200 psi / 13.6bar but not brake lines. Suitability, we make the following general recommendations, if flow rates are known we can advise more accurately. More pressure drop will be experienced when valves are fitted.

JT2 series	Fuel lines up to 5 litre road cars, pressure gauges, transmission oil coolers
JT3 series	Fuel lines for over 5 litre competition cars. Engine oil cooler, dry sump pressure pipes for engines up to 2 litres
JT5 series	Engine oil cooler pipes, dry sump to tank pipes, dry sump pressure pipes for engines over 2 litres. Coolant pipes.

First 3 characters of part No identifies Series

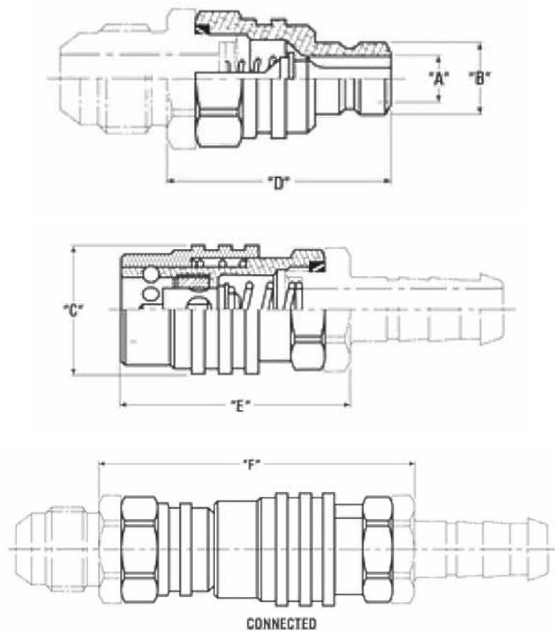

Series	A inches	B inches	C inches	D inches	E inches	F inches
JT2	0.24	0.37	0.75	1.68 max	1.86 max	3.13 max
JT3	0.37	0.53	1.03	2.01 max	2.34 max	3.74 max
JT5	0.59	0.78	1.37	2.69 max	2.69 max	5.25 max

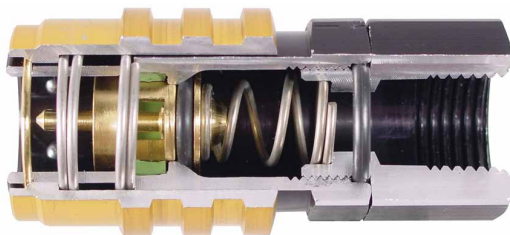

Internal view of a standard Jiffy-tite socket

We stock the components shown below, however a wider range is available and we can supply Sockets to NPTF female, Sockets to JIC male, Plugs to FC333 hose end. We will be making a number of plug adapters to suit markets outside of the USA e.g. Metric, BSP etc, please enquire.

Lanyard fittings - Disconnects automatically when exposed to the stresses of impact preventing dangerous leaks in a crash situation. Fittings are available in all series. Available to special order.

## Socket To FC333 Type Hose



Fits Aeroquip type hose e.g. Aeroquip FC333 racing hose or copies, e.g. **MOCAL** Racing Hose and G210; Earls Performo-o-flex; 200 etc, and Aeroquip Startlite.

### Socket Straight

Part No	Description
JT21604	-4 FC333 Hose End - Valved
JT21604A	-4 FC333 Hose End - Non-Valved
JT21606	-6 FC333 Hose End - Valved
JT21606A	-6 FC333 Hose End - Non-Valved
JT31606	-6 FC333 Hose End - Valved
JT31606A	-6 FC333 Hose End - Non-Valved
JT31608	-8 FC333 Hose End - Valved
JT31608A	-8 FC333 Hose End - Non-Valved
JT51610	-10 FC333 Hose End - Valved
JT51610A	-10 FC333 Hose End - Non-Valved
JT51612	-12 FC333 Hose End - Valved
JT51612A	-12 FC333 Hose End - Non-Valved

### Socket 45°

Part No	Description
JT21606D	-6 FC333 Hose End - Valved
JT21606DA	-6 FC333 Hose End - Non-Valved
JT31608D	-8 FC333 Hose End - Valved
JT31608DA	-8 FC333 Hose End - Non-Valved
JT51610D	-10 FC333 Hose End - Valved
JT51610DA	-10 FC333 Hose End - Non-Valved

### Socket 90°

Part No	Description
JT21606E	-6 FC333 Hose End - Valved
JT21606EA	-6 FC333 Hose End - Non-Valved
JT31608E	-8 FC333 Hose End - Valved
JT31608EA	-8 FC333 Hose End - Non-Valved
JT51610E	-10 FC333 Hose End - Valved
JT51610EA	-10 FC333 Hose End - Non-Valved

## Plug To FC333 Type Hose



### Plug Straight

Part No	Description
JT22604	-4 FC333 Hose End - Valved
JT22604A	-4 FC333 Hose End - Non-Valved
JT22606	-6 FC333 Hose End - Valved
JT22606A	-6 FC333 Hose End - Non-Valved
JT32606	-6 FC333 Hose End - Valved
JT32606A	-6 FC333 Hose End - Non-Valved
JT32608	-8 FC333 Hose End - Valved
JT32608A	-8 FC333 Hose End - Non-Valved
JT52610	-10 FC333 Hose End - Valved
JT52610A	-10 FC333 Hose End - Non-Valved
JT52612	-12 FC333 Hose End - Valved
JT52612A	-12 FC333 Hose End - Non-Valved

### Plug 45°

Part No	Description
JT22606D	-6 FC333 Hose End - Valved
JT32608D	-8 FC333 Hose End - Valved
JT52610D	-10 FC333 Hose End - Valved

### Plug 90°

Part No	Description
JT22606E	-6 FC333 Hose End - Valved
JT32608E	-8 FC333 Hose End - Valved
JT52610E	-10 FC333 Hose End - Valved

## Socket To Barb For FC333 Type Hose



For Aeroquip type hoses as FC333 offers a cheaper alternative for very low pressure applications. All hoses must be secured by factory swaging, worm drive, O clamps Pro-clamps or Mocclamps (pg 50 - 51). Sizes larger than -6 tend to be higher pressure; available to special order. Plugs to special order.

### Socket Straight

Part No	
JT21503	-3 Hose - Valved
JT21503A	-3 Hose - Non-Valved
JT21504	-4 Hose - Valved
JT21504A	-4 Hose - Non-Valved
JT21506	-6 Hose - Valved
JT21506A	-6 Hose - Non-Valved
JT31506	-6 Hose - Valved
JT31506A	-6 Hose - Non-Valved

### Socket 45°

Part No	
JT21506D	-6 Hose - Valved
JT31508D	-8 Hose - Valved
JT51510D	-10 Hose - Valved

### Socket 90°

Part No	
JT21506E	-6 Hose - Valved
JT31508E	-8 Hose - Valved
JT51510E	-10 Hose - Valved

## Socket To JIC Female



### Socket 45°

Part No	
JT21303	-3JIC Female Adapter - Valved
JT21303A	-3JIC Female Adapter - Non-Valved
JT21304	-4JIC Female Adapter - Valved
JT21304A	-4JIC Female Adapter - Non-Valved
JT21306	-6JIC Female Adapter - Valved
JT21306A	-6JIC Female Adapter - Non-Valved
JT31306	-6JIC Female Adapter - Valved
JT31306A	-6JIC Female Adapter - Non-Valved
JT31308	-8JIC Female Adapter - Valved
JT31308A	-8JIC Female Adapter - Non-Valved

## Plug To JIC Female



### Plug Straight

Part No	
JT22303	-3JIC Female Adapter - Valved
JT22303A	-3JIC Female Adapter - Non-Valved
JT22304	-4JIC Female Adapter - Valved
JT22304A	-4JIC Female Adapter - Non-Valved
JT22306	-6JIC Female Adapter - Valved
JT22306A	-6JIC Female Adapter - Non-Valved
JT32306	-6JIC Female Adapter - Valved
JT32306A	-6JIC Female Adapter - Non-Valved
JT32308	-8JIC Female Adapter - Valved
JT32308A	-8JIC Female Adapter - Non-Valved
JT52308	-8JIC Female Adapter - Valved
JT52308A	-8JIC Female Adapter - Non-Valved
JT52310	-10JIC Female Adapter - Valved
JT52310A	-10JIC Female Adapter - Non-Valved
JT52312	-12JIC Female Adapter - Valved
JT52312A	-12JIC Female Adapter - Non-Valved

### Plug 45°

Part No	
JT22306D	-6JIC Female Adapter - Valved
JT32308D	-8JIC Female Adapter - Valved
JT52310D	-10JIC Female Adapter - Valved

### Plug 90°

Part No	
JT22306E	-6JIC Female Adapter - Valved
JT32308E	-8JIC Female Adapter - Valved
JT52310E	-10JIC Female Adapter - Valved

## Plug To JIC Male And M22 Male



### Plug Straight

Part No	
JT22403	-3JIC Male Adapter - Valved
JT22403A	-3JIC Male Adapter - Non-Valved
JT22404	-4JIC Male Adapter - Valved
JT22404A	-4JIC Male Adapter - Non-Valved
JT32406	-6JIC Male Adapter - Valved
JT32406A	-6JIC Male Adapter - Non-Valved
JT32408	-8JIC Male Adapter - Valved
JT52410	-10JIC Male Adapter - Valved
JT52412	-12JIC Male Adapter - Valved
JT52122	M22x1.5 Male Adapter - Valved

### Plug 45°

Part No	
JT32406D	-6JIC Male Adapter - Valved
JT32408D	-8JIC Male Adapter - Valved
JT52410D	-10JIC Male Adapter - Valved
JT52122D	M22x1.5 Male Adapter - Valved

### Plug 90°

Part No	
JT32406E	-6JIC Male Adapter - Valved
JT32408E	-8JIC Male Adapter - Valved
JT52410E	-10JIC Male Adapter - Valved
JT52122E	M22x1.5 Male Adapter - Valved

## Socket To JIC Male



### Socket Straight

Part No	
JT21403	-3JIC Male Adapter - Valved
JT21403A	-3JIC Male Adapter - Non-Valved
JT21404	-4JIC Male Adapter - Valved
JT21404A	-4JIC Male Adapter - Non-Valved
JT31406	-6JIC Male Adapter - Valved
JT31406A	-6JIC Male Adapter - Non-Valved
JT31408	-8JIC Male Adapter - Valved
JT31408A	-8JIC Male Adapter - Non-Valved
JT51410	-10JIC Male Adapter - Valved
JT51410A	-10JIC Male Adapter - Non-Valved
JT51412	-12JIC Male Adapter - Valved
JT51412A	-12JIC Male Adapter - Non-Valved

### Socket 45°

Part No	
JT31406D	-6JIC Male Adapter - Valved
JT31408D	-8JIC Male Adapter - Valved
JT51410D	-10JIC Male Adapter - Valved

### Socket 90°

Part No	
JT31406E	-6JIC Male Adapter - Valved
JT31408E	-8JIC Male Adapter - Valved
JT51410E	-10JIC Male Adapter - Valved

Suffix 'F' directly after last number and before any letters to order with EPDM seals for clutch, e.g. JT51410F for -10JIC valved male adapter with EPDM seal; JT5141FE for -10JIC 90° valved male adapter. Price on application.

## Plug To NPTF Male



Sockets to NPTF male are available to special order

### JT SERIES 2

Part No	Description
JT22802	1/8 NPT Male Adapter - Valved
JT22802A	1/8 NPT Male Adapter - Non-Valved
JT22804	1/4 NPT Male Adapter - Valved
JT22804A	1/4 NPT Male Adapter - Non-Valved

### JT SERIES 3

Part No	Description
JT32804	1/4 NPT Male Adapter - Valved
JT32804A	1/4 NPT Male Adapter - Non-Valved
JT32806	3/8 NPT Male Adapter - Valved
JT32806A	3/8 NPT Male Adapter - Non-Valved

### JT SERIES 5

Part No	Description
JT52806	3/8 NPT Male Adapter - Valved
JT52806A	3/8 NPT Male Adapter - Non-Valved
JT52808	1/2 NPT Male Adapter - Valved
JT52808A	1/2 NPT Male Adapter - Non-Valved
JT52812	3/4 NPT Male Adapter - Valved
JT52812A	3/4 NPT Male Adapter - Non-Valved

## Socket To Push Lock Hose



Use with push on or special push to lock hose as in Aeroquip socketless, FBN or FBV series.

### Socket Straight

Part No	Description
JT21504P	1/4in ID Hose - Valved
JT21504AP	1/4in ID Hose - Non-Valved
JT31506P	3/8in ID Hose - Valved
JT31506AP	3/8in ID Hose - Non-Valved
JT31508P	1/2in ID Hose - Valved
JT31508AP	1/2in ID Hose - Non-Valved
JT51510P	5/8in ID Hose - Valved
JT51510AP	5/8in ID Hose - Non-Valved
JT51512P	3/4in ID Hose - Valved
JT51512AP	3/4in ID Hose - Non-Valved

## Socket To Push Lock Hose 45°



### Socket 45°

Part No	Description
JT21504PD	1/4in ID Hose - Valved
JT21504APD	1/4in ID Hose - Non-Valved
JT21506PD	3/8in ID Hose - Valved
JT21506APD	3/8in ID Hose - Non-Valved
JT31508PD	1/2in ID Hose - Valved
JT31508APD	1/2in ID Hose - Non-Valved
JT51510PD	5/8in ID Hose - Valved
JT51510APD	5/8in ID Hose - Non-Valved
JT51512PD	3/4in ID Hose - Valved
JT51512APD	3/4in ID Hose - Non-Valved

## Socket To Push Lock Hose 90°



### Socket 90°

Part No	Description
JT21506PE	3/8in ID Hose - Valved
JT21506APE	3/8in ID Hose - Non-Valved
JT31508PE	1/2in ID Hose - Valved
JT31508APE	1/2in ID Hose - Non-Valved
JT51510PE	5/8in ID Hose - Valved
JT51510APE	5/8in ID Hose - Non-Valved
JT51512PE	3/4in ID Hose - Valved
JT51512APE	3/4in ID Hose - Non-Valved

## Plug To Push On Hose



### Plug Straight

Part No	Description
JT22504P	1/4in ID Hose - Valved
JT22504AP	1/4in ID Hose - Non-Valved
JT32506P	3/8in ID Hose - Valved
JT32506AP	3/8in ID Hose - Non-Valved
JT32508P	1/2in ID Hose - Valved
JT32508AP	1/2in ID Hose - Non-Valved
JT52510P	5/8in ID Hose - Valved
JT52510AP	5/8in ID Hose - Non-Valved
JT52512P	3/4in ID Hose - Valved
JT52512AP	3/4in ID Hose - Non-Valved

### Plug 45°

Part No	Description
JT22504PD	1/4in ID Hose - Valved
JT22504APD	1/4in ID Hose - Non-Valved
JT22506PD	3/8in ID Hose - Valved
JT32506PD	3/8in ID Hose - Valved
JT32506APD	3/8in ID Hose - Non-Valved
JT32508PD	1/2in ID Hose - Valved
JT52510PD	5/8in ID Hose - Valved
JT52510APD	5/8in ID Hose - Non-Valved
JT52512PD	3/4in ID Hose - Valved
JT52512APD	3/4in ID Hose - Non-Valved

### Plug 90°

Part No	Description
JT22504PE	1/4in ID Hose - Valved
JT22504APE	1/4in ID Hose - Nonvalved
JT22506PE	3/8in ID Hose - Valved
JT32506PE	3/8in ID Hose - Valved
JT32506APE	3/8in ID Hose - Non-Valved
JT32508PE	1/2in ID Hose - Valved
JT52508PE	1/2in ID Hose - Valved
JT52508APE	1/2in ID Hose - Non-Valved
JT52510PE	5/8in ID Hose - Valved
JT52510APE	5/8in ID Hose - Non-Valved
JT52512EP	3/4in ID Hose - Valved
JT52512EPA	3/4in ID Hose - Non-Valved

## Dust Caps & Dust Plugs



Part No	Description
JTMS2000C	2000 Series Cap
JTMS2000P	2000 Series Plug
JTMS3000C	3000 Series Cap
JTMS3000P	3000 Series Plug
JTMS5000C	5000 Series Cap
JTMS5000P	5000 Series Plug

## One Way Check Valves

### Flap & Disc Valves



Construction: anodised aluminium housing with either a disc or a flap valve. Application: Disc valve has slight flow resistance but suitable for fuel systems. Flap valve has no detectable resistance to flow, more suited to high flow oil systems, the latter are prohibitively expensive but sometimes available on the surplus market at reasonable cost, therefore supplies tend to be erratic and prices may vary.

Part No	
CVD14-5	5/16in Push On Tails Disc
CVD7-4	-4JIC Disc
CVD7-6	-6JIC Disc
CVD7-8	-8JIC Disc
CVF7-6B	-6JIC Flap
CVF7-8B	-8JIC Flap
CVF7-10	-10JIC Flap
CVF7-12	-12JIC Flap
CVF7-16	-16JIC Flap
CVF2-105	M22 Female

## Quick Release Drybreak Couplings

Aeroquip have a large industrial range of such couplings, we have selected only those ranges and sizes suited to light vehicle usage. We can supply items from the aerospace range, but the high price and long delivery time make them a barely viable proposition. All couplings will withstand pressures in excess of 3000 psi.



### FD 56 Series

Construction: Aeroquip steel couplings with push pull action, have a small amount of air inclusion (0.5cc for FBM 3011)

Application: Used on brake/clutch systems (EPR seals). Ideal for fuel/

Part No	
FBM3011	Complete Assembly Buna Seals 1/4NPTF Female
FBM3012	Complete Assembly Buna Seals 3/8NPTF Female
FBM3013	Complete Assembly Buna Seals 1/2NPTF Female
FBM1153	Aluminium Male Half Buna Seals 1/2NPTF Female
FBM3113	Quick Disconnect Coupling 1/2NPTF Female
FBM3114	Aluminium Female Half Buna Seals 1/2NPTF Female
5601-8-10S	Steel Female Half Buna Seals 1/2NPTF Female
B5600-4-4	Complete Assembly Buna Seals 1/4BSP Female
B5600-6-6	Complete Assembly Buna Seals 3/8BSP Female
B5600-8-10	Complete Assembly Buna Seals.1/2BSP Female

oil lines and air starters.



### FD 90 (FCM3080) Series

FIA approved coupling for fuel sampling.

Construction: Aeroquip steel coupling with push pull action.

Application: Designed for use with pressure gauges in diagnostic applications, seals not suitable for long term brake/clutch use.

Part No	
FBM3081	Female Half (Socket) Tapped 1/8NPTF
FBM3085	Male Half (Plug) Tapped 1/8NPTF
FBM3083	Male Half (Plug) With 1/8NPTF Male
FBM3082	Female Half (Socket) Tapped 1/4NPTF
FBM3086	Male Half (Plug) Tapped 1/4NPTF
FBM3084	Male Half (Plug) With 1/4NPTF Male
FBM3087	Dust Cap For Male Halves

Minimal air inclusion (0.02cc).



### FD 54 (FBM3079) Series

Construction: An Aeroquip threaded steel coupling with provision for bulkhead mounting. Compact and lightweight with very little air inclusion (0.1cc). Overall length 3.52" connected. Application: The

Part No	
FBM3079	Complete Assembly With -4JIC Male Unions
Alternative End Fittings	
FD547-3	-3JIC Male Union
FD543-3	1/8BSP Male Union
FD543-3F	1/8 BSP Female Union
FD54HE-3	To Take -3 TFE Hose

finest low cost connection for brake & clutch use. Has EPR seals.



### Push-Pull Quick Connect Brake & Clutch Coupling

Aeroquip plated mild steel with EPR seals, length connected is 4.10 inches and weight 0.34 lbs. Max operating pressure 3000psi, max temperature 120°C. Allows rapid connection & disconnection of brake & clutch lines with little fluid loss, 0.10cc max, minute air inclusion 0.02 cc max, obviating the need for bleeding. A safety clip-on lanyard is attached to the coupling to prevent accidental

Part No	
FBM1073	Complete Assembly Steel -3JIC Male - Bulkhead One End
FBM1074	Complete Assembly Steel -4JIC Male - Bulkhead One End

disconnection.

A selection of Staubli connections are also available. Please enquire.



## Fuel Sampling Kits



As of 2015 the MSA states in its Blue Book (page 85 [D(34)]) that cars competing in British or MSA titled championships must have a system built in to enable taking a fuel sample. Furthermore, if a dry-break coupling is used, it must be FIA approved. We have a number of kits available using the FIA approved Aeroquip FD90 coupling with various methods of interrupting the fuel flow. We recommend that you have both halves of the system so that you can maintain the integrity of your sample.

Part No	
FSK1	Fuel Sampling Kit -6JIC Male/Female
FSK2	Fuel Sampling Kit -6JIC Male/Male
FSK3	Fuel Sampling Kit 8mm Push On
FSK1PO	FSK1 Plug Only -6JIC Male/Female
FSK2PO	FSK2 Plug Only -6JIC Male/Male
FSK3PO	FSK3 Plug Only 8mm Push On

## Brake & Clutch Cylinders



Girling manufactured. Master cylinders have 1.4" stroke with 7/16UNF inlet with concave seating and 3/8UNF outlet with convex seating. The reservoirs either screw directly to master cylinder or may be mounted remotely and fed through a 7mm hose.

Part No	
MAS1	0.625" ID Girling Master Cylinder
MAS2	0.70" ID Girling Master Cylinder
MAS3	0.75" ID Girling Master Cylinder
MAS4	0.70" ID Girling Master Cylinder With Internal Reservoir
MAS5	0.75" ID Girling Master Cylinder With Internal Reservoir
MAS6	0.625" ID Girling Master Cylinder With Internal Reservoir
MAS7	Master Cylinder -0.700"
MAS8	Master Cylinder -0.813"
MAS9	Master Cylinder -0.625"
RES1	Reservoir For Direct Mount On Cylinder
RES2	Reservoir For Remote Mount
RES3	Reservoir In Tin, Tall
RES4	Reservoir In Tin, Short
SLA1	Clutch Slave Cylinder

## Residual Pressure Valves



These in-line pressure valves retain a minimum brake line pressure to help eliminate excessive pedal travel. Use 2psi for discs and 10psi for drums. Made from billet aluminium. Size 40mm x 16mm

Part No	
RPV1	2psi - 1/8NPTF Tappings
RPV2	10psi - 1/8NPTF Tappings

## Taps



Use for fuel shut off and air jack control. Stainless steel ball valve in teflon seating. Steel body has Nylon handle, Aluminium body has Aluminium handle.

### Chromed Steel Body

Part No	
TAP3-4	Tap With 1/4BSP Female Ports
TAP3-6	Tap With 3/8BSP Female Ports
TAP3-8	Tap With 1/2BSP Female Ports
TAP3-6-5	Tap With Male For 5/16in ID (Pictured)
TAP3-6-6	Tap With Male For 3/8in ID Hose
TAP3-4-4	Tap With Male For 1/4in ID Hose

### Aluminium Body

Part No	
TAP7-6	-6JIC Male Ali Handle With Lanyard Hole
TAP7-8	-8JIC Male Ali Handle With Lanyard Hole
TAP7-10	-10JIC Male Ali Handle With Lanyard Hole
TAP7-12	-12JIC Male Ali Handle With Lanyard Hole

## Seals, Washers & Gaskets



We stock an extensive range of sealing rings, popular items are listed but others are available. Bonded seals are Nitrile.

Part No	
BS1/4	Bonded Seal 1/4in
BS5/16	Bonded Seal 5/16in
BS3/8	Bonded Seal 3/8in For 1/8BSP
BS7/16	Bonded Seal 7/16in
BS1/2	Bonded Seal 1/2in For 1/4BSP
BS9/16	Bonded Seal 9/16in & M14
BS5/8	Bonded Seal 5/8in
BS11/32	Bonded Seal 11/32in
BS21/32	Bonded Seal 21/32in For 3/8BSP
BS3/4	Bonded Seal 3/4in
BS13/16	Bonded Seal 13/16in For 1/2BSP
BS7/8	Bonded Seal 7/8in For 5/8BSP
BS15/16	Bonded Seal 15/16in
BS1	Bonded Seal 1in For 3/4BSP
BSSC-M12	Bonded Seal M12 Self Centre
BSSC-M14	Bonded Seal M14 Self Centre
BSSC-M18	Bonded Seal M18 Id Self Centre
BS-M20	Bonded Seal M20 ID
BS-M22	Bonded Seal M22 ID
BS-M28	Bonded Seal M28 ID
BS-M4	Bonded Seal M4 Self Centre
BS-M5	Bonded Seal M5 ID
BS-M8	Bonded Seal M8 ID
WCS-M10	Washer Solid Copper M10
WCS3/8	Washer Solid Copper 3/8in & 1/8BSP
WCS7/16	Washer Solid Copper 7/16in ID
WCM18	Washer Folded Copper For M8
WC-3/8	Washer Folded Copper 3/8in For 1/8BSP
WC-M10	Washer Folded Copper M10
WC-M12	Washer Folded Copper M12
WC-1/4	Washer Folded Copper 1/2in For 1/4BSP
WC9/16	Washer Folded Copper M14 Or 9/16in
WC5/8	Washer Folded Copper 5/8BSP
WC3/8	Washer Folded Copper M16 For 3/8BSP
WC3/4	Washer Folded Copper 3/4in
FBM3642	Aluminium 3/8in For -3JIC & M10
FBM3513	Aluminium 7/16in For -4JIC
FBM3514	Aluminium 9/16in For -6JIC
FBM3515	Aluminium 3/4in For -8JIC
FBM3516	Aluminium 7/8in For -10JIC
FBM3517	Aluminium 1+1/16in For -12JIC

## Aeroquip Firesleeve



Single layer of braided fibreglass tubing impregnated with flame resistant rubber. Protects from direct flame. Slips over any kind of hose before assembly and seal ends with heat resisting silicone tape. Temp range -65°F/-54°C to +450°F/+232°C.

### Aeroquip

Part No	inch	mm
FBS0500	0.31 ID	7.8mm
FBS0700	0.44 ID	11.2mm
FBS0800	0.50 ID	12.7mm
FBS0900	0.56 ID	14.2mm
FBS1000	0.62 ID	15.7mm
FBS1100	0.69 ID	17.5mm
FBS1200	0.75 ID	19.0mm
FBS1300	0.81 ID	20.6mm
FBS1400	0.88 ID	22.4mm
FBS1600	1.00 ID	25.4mm
FBS1800	1.12 ID	28.4mm
FBS2000	1.25 ID	31.8mm
FBS2200	1.38 ID	35.1mm
FBS2400	1.50 ID	38.1mm

## Heat Resisting Tape

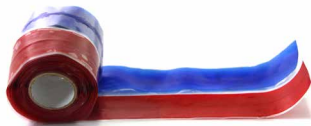

Silicone tape with tear off backing. This specially formulated self-amalgamating tape bonds to itself without any adhesive. Wrap the tape tightly around the substrate, and it will cure to itself without leaving any sticky residue. It has a centre line to enable alignment of overlaps. Temp range -40°C to 220°C.

### Part No

ST1	Flame Guard Silicone Tape Blue 3m Roll
ST1RED	Flame Guard Silicone Tape Red 3m Roll

## Aluminised Heat Resisting Cloth



Used to protect against heat. Stick to bulkheads for cooler interior, cover air cleaners for cooler charge, protect hoses and cables. The aluminium foil is highly heat reflective and water & oil resistant, the cloth will withstand 550°C but the foil may loosen at lower temperatures. Construction: Woven glass fabric, aluminised on one side with foil. We offer three thicknesses/weights, 0.4mm/520g/m<sup>2</sup>, 0.7mm/900g/m<sup>2</sup>, 1.4mm/1000g/m<sup>2</sup>.

High temperature contact adhesive suitable for above, also leather cloth, carpets rubber, grp, steel, aluminium etc. Brushable (has a far higher temperature than aerosol spray).

### MOCAL

Part No	
AGC1	0.4mm Thick - 1m Wide Clothing
AGC2	0.7mm Thick - 1m Wide Clothing
AGC3	1.6mm Thick - 1m Wide Clothing
HTA1	1 Litre Can High Temperature Adhesive

### THERMOTEC

Part No	
TTEC13575	12in (300mm) X 24 (600mm) Adhesive Backed
TTEC14002	Thermoshield Tape 1.5in Wide X 15ft (4.6m)

## Aluminised Heat Resisting Sleeves



Heat resisting sleeve protects from radiant heat.

### Part No

TS-M10	10mm Inside Diameter
TS-M14	14mm Inside Diameter
TS-M20	20mm Inside Diameter
TS-M30	30mm Inside Diameter
TS-M35	35mm Inside Diameter

## Heat Resistant Sleeve



This heat resistant sleeve is lighter and less bulky than Aeroquip firesleeve is made from woven fibreglass with a silver silicon rubber coating. Temp range -40°C to 220°C.

### Part No

FG-08	8mm ID Flameguard Silver
FG-12	12mm ID Flameguard Silver
FG-15	15mm ID Flameguard Silver
FG-22	22mm ID Flameguard Silver

## Heat Shrink Sleeve



Black high grade PVC, minimum shrink temperature 130°C, shrink ratio is 2:1.

### Part No

HS-3-4	0.38in ID For -3 & -4 Tfe Hose
HS-4-6	0.63in ID For -4 & -6 Racing Hose
HS-6-8	0.75in ID For -6 & -8 Racing Hose
HS-8-12	1.00in ID For -8, -10 & -12 Racing Hose
HS-10-20	1.50in ID For -12, -16 & -20 Racing Hose

## Exhaust Pipe Wrap Webbing



Application: It is widely claimed that insulating the exhaust manifold pipes will produce more horsepower, it will certainly reduce under bonnet temperatures with consequent benefits. Daily use may lead to more rapid corrosion of thin section manifolds. Secure with stainless steel cable/hose ties.

### MOCAL

Part No	
EPW1	1.5mm Thick- 50mm Wide, Biege 550°C
EPW1B	1.5mm Thick- 50mm Wide, Black 550°C
EPW1M	1.5mm Thick- 50mm Wide, Magma 1000°C
EPWT-2	Pack Of 6 Stainless Steel Self Fixing Ties; 4 @20cm, 2 @ 30cm Enough For 2 Cylinders

### Thermotec

Part No	
TTEC11001	1in (25mm) Wide X 50ft Long (15m)- Light Brown
TTEC11031	As Above Copper
TTEC11002	2in (50mm) Wide X 50ft Long (15m)- Light Brown
TTEC11032	As Above Copper

## Grommet Seals



Grommet seals serve to keep unwanted smoke and fumes from entering the driver's area while protecting lines from chafing and abrading on rough surfaces. They provide the finishing touch to all through panel installations. Suitable for fuel and oil lines, air and liquid hoses, wiring etc. Manufactured from flame retardant nitrile bonded to anodised aluminium backing plate.

We recommend a rubber ID 1/16"/1.5mm smaller than item passing through and a rubber OD 3/8"/9.5mm bigger than largest part of item e.g. fixing nut. Use a lubricant, e.g. petroleum or silicon jelly. Also available blank (no hole) suitable for punching, we will build up a collection of punches for in house custom applications. Aluminium backing plates are drilled 1/8"/3.2mm for fixing. Suitable stainless self-tapping screws can be supplied in packs of ten.

### One Hole



Part No	
GS2003-5	Blank 1in Rubber ID 1.5in Overall OD
GS50238-BL	Blank 1.55in Rubber ID 2in Overall OD
GS1003-BL	Blank 2.25in Rubber ID 3in Overall OD
GS1003-4	1/4in Rubber ID 2.25in Overall OD
GS1003-6	3/8in Rubber ID 2.25in Overall OD
GS1003-8	1/2in Rubber ID 2.25in Overall OD
GS1003-10	5/8in Rubber ID 2.25in Overall OD
GS1003-12	3/4in Rubber ID 2.25in Overall OD
GS1003-16	1in Rubber ID 2.25in Overall OD
GS1003-20	1.2in Rubber ID 2.25in Overall OD
GS404-BL	Blank 3in Rubber ID 4in Overall OD
GS404-16	1in Rubber ID 3in Overall OD
GS404-30	1.75in Rubber ID 3in Overall OD
GS5001-1	1.5in Rubber ID 3.4in Overall OD
GS5001-2	2in Rubber ID 3.4in Overall OD
GS1003-6INBL	Blank 5in Rubber ID 6in Overall OD

### Two Hole



Part No	
GS101-NHBL	Blank 5.25in Overall Width 0.19in Thick
GS101-2H-16S	1.5 ID Holes 5.25in Overall Width
GS101-2H-BL	Blank 5.25in Overall Width 0.16in Thick
GS101-2H-4	1/4in ID Holes 5.25in Overall Width
GS101-2H-6	3/8in ID Holes 5.25in Overall Width
GS101-2H-8	1/2in ID Holes 5.25in Overall Width
GS101-2H-10	5/8in ID Holes 5.25in Overall Width
GS101-2H-12	3/4in ID Holes 5.25in Overall Width
GS101-2H-16	1in ID Holes 5.25in Overall Width
GS1003-2H-BL	Blank 5.75in Overall Width
GS1003-2H-4	1/4in ID Holes 5.75in Overall Width
GS1003-2H-6	3/8in ID Holes 5.75in Overall Width
GS1003-2H-8	1/2in ID Holes 5.75in Overall Width
GS1003-2H-10	5/8in ID Holes 5.75in Overall Width
GS1003-2H-12	3/4in ID Holes 5.75in Overall Width
GS1003-2H-16	1in ID Holes 5.75in Overall Width

## Three Hole



Part No	
GS1003-3H-BL	Blank 8.5in Overall Width
GS1003-3H-4	1/4in ID Holes 8.5in Overall Width
GS1003-3H-6	3/8in ID Holes 8.5in Overall Width
GS1003-3H-8	1/2in ID Holes 8.5in Overall Width
GS1003-3H-10	5/8in ID Holes 8.5in Overall Width
GS1003-3H-12	3/4in ID Holes 8.5in Overall Width
GS1003-3H-16	1in ID Holes 8.5in Overall Width

## Bellows



Part No	
GS50238	0.416in Rubber ID 2in Overall OD
GS2003-5WPT	No Hole 1.5in Overall OD Pointed
GS4001-WPT	No Hole 2.0in Overall OD Pointed

## Recessed



Part No	
GS-SB1	0.416in Rubber ID 3in Overall OD

## Split



Part No	
SGS-250	1/4in Rubber ID
SGS-375	3/8in Rubber ID
SGS-500	1/2in Rubber ID
SGS-625	5/8in Rubber ID
SGS-750	3/4in Rubber ID
SGS-875	7/8in Rubber ID
SGS-1000	1in Rubber ID
SGS3-5-BL	0in Rubber ID

## Hose Support T Clips



Hold tubing, hoses and wire away from application, eliminating vibration and paint chafing, Made from Zytel nylon, will not melt, fade, stain, corrode or discolour. They will not crack from heat and cold and are non-conductive. Supplied with a stainless steel bolts long enough to fix to sheet metal etc, Size is 10-32 UNF except doubles 13/16" and over which are 1/4-20 UNF. We stock black but also blue, red, yellow, grey & purple available, please state what colour you require.

## Single Place T Clips



Part No	
NHSC10-188	3/16in ID - 4mm Fixing Hole 8 Pack
NHSC10-250	1/4in ID - 4mm Fixing Hole 8 Pack
NHSC10-313	5/16in ID - 4mm Fixing Hole 8 Pack
NHSC10-375	3/8in ID - 4mm Fixing Hole 8 Pack
NHSC10-437	7/16in ID - 4mm Fixing Hole 6 Pack
NHSC10-500	1/2in ID - 4mm Fixing Hole 6 Pack
NHSC10-562	9/16in ID - 4mm Fixing Hole 6 Pack
NHSC10-625	5/8in ID - 4mm Fixing Hole 6 Pack
NHSC10-650	11/16in ID - 4mm Fixing Hole 4 Pack
NHSC10-820	13/16in ID - 4mm Fixing Hole 4 Pack

## Double Place T Clips



Part No	
NHSC20-252	1/4in & 1/4in ID - 4mm Fixing Hole 6 Pack
NHSC20-258	1/4in & 3/16in ID - 4mm Fixing Hole 6 Pack
NHSC20-288	3/16in & 3/16in ID - 4mm Fixing Hole 6 Pack
NHSC20-323	5/16in & 5/16in ID - 4mm Fixing Hole 6 Pack
NHSC20-327	5/16in & 3/8in ID - 4mm Fixing Hole 6 Pack
NHSC20-357	3/8in & 3/16in ID - 4mm Fixing Hole 6 Pack
NHSC20-377	3/8in & 3/8in ID - 4mm Fixing Hole 6 Pack
NHSC20-432	7/16in & 7/16in ID - 4mm Fixing Hole 4 Pack
NHSC20-502	1/2in & 1/2in ID - 4mm Fixing Hole 4 Pack
NHSC20-522	9/16in & 9/16in ID - 4mm Fixing Hole 4 Pack
NHSC20-622	5/8in & 5/8in ID - 4mm Fixing Hole 4 Pack
NHSC20-652	11/16in & 11/16in ID - 4mm Fixing Hole 4 Pack
NHSC20-822	13/16in & 13/16in ID - 6.4mm Fixing Hole 2 Pack
NHSC20-823	13/16in & 15/16in ID - 6.4mm Fixing Hole 2 Pack
NHSC20-835	15/16in & 15/16in ID - 6.4mm Fixing Hole 2 Pack
NHSC20-836	15/16in & 1+1/16in ID - 6.4mm Fixing Hole 2 Pack

## Mount To Tube T Clips



Designed to fit to 1 5/8" chassis tube and then hold required hose size.

Part No	
NHSC41-43751	7/16in ID 2 Pack
NHSC41-50051	1/2in ID 2 Pack
NHSC41-56251	9/16in ID 2 Pack
NHSC41-62551	5/8in ID 2 Pack
NHSC41-65051	11/16in ID 2 Pack
NHSC41-82051	13/16in ID 2 Pack
NHSC41-83551	15/16in ID 2 Pack

## Hose Support P Clips



Application: Use to secure cables, hoses to chassis, bodywork, etc.  
Construction: Aeroquip clips (prefix FBM in price list) are vinyl coated plated mild steel with a wide band and large fixing hole of 0.4 or 0.5 inch. Clips with prefix HSC are rubber sleeved aluminium and are often preferred due to their smaller fixing hole and narrow band. Clips with PHSC prefix are a simple low cost plastic clip.

### Aeroquip Mild Steel

Part No	
FBM3481	0.25in ID 0.4in Fixing Hole
FBM3482	0.44in ID 0.4in Fixing Hole
FBM3483	0.50in ID 0.4in Fixing Hole
FBM3484	0.56in ID 0.4in Fixing Hole
FBM3485	0.63in ID 0.4in Fixing Hole
FBM3486	0.75in ID 0.4in Fixing Hole
FBM3487	0.81in ID 0.4in Fixing Hole
FBM3488	0.94in ID 0.4in Fixing Hole
FBM3534	1.00in ID 0.4in Fixing Hole
FBM3535	1.06in ID 0.4in Fixing Hole
FBM3536	1.13in ID 0.5in Fixing Hole
FBM3537	1.25in ID 0.5in Fixing Hole
FBM3538	1.50in ID 0.5in Fixing Hole

### Aluminium

Part No	
HSC4	0.19in ID 0.16in Fixing Hole
HSC1	0.25in ID 0.16in Fixing Hole
HSC2	0.31in ID 0.16in Fixing Hole
HSC3	0.37in ID 0.16in Fixing Hole
HSC13	0.50in ID 0.16in Fixing Hole
HSC14	0.56in ID 0.16in Fixing Hole
HSC5	0.63in ID 0.16in Fixing Hole
HSC9	0.69in ID 0.16in Fixing Hole
HSC10	0.75in ID 0.16in Fixing Hole
HSC6	0.81in ID 0.16in Fixing Hole
HSC11	0.87in ID 0.16in Fixing Hole
HSC7	0.94in ID 0.16in Fixing Hole
HSC12	1.00in ID 0.16in Fixing Hole
HSC8	1.25in ID 0.16in Fixing Hole

### Plastic

Part No	
PHSC-M3	3.2mm ID 4.6mm Fixing Hole
PHSC-M5	4.8mm ID 4.6mm Fixing Hole
PHSC-M6	6.3mm ID 4.6mm Fixing Hole
PHSC-M8	7.9mm ID 4.6mm Fixing Hole
PHSC-M10	9.5mm ID 4.6mm Fixing Hole
PHSC-M13	12.7mm ID 4.6mm Fixing Hole
PHSC-M16	15.8mm ID 4.6mm Fixing Hole
PHSC-M19	19.4mm ID 4.6mm Fixing Hole
PHSC-M25	25.4mm ID 4.6mm Fixing Hole
PHSC-M27	27.5mm ID 4.6mm Fixing Hole
PHSC-M32	31.8mm ID 4.6mm Fixing Hole
PHSC-M37	36.17mm ID 4.6mm Fixing Hole

## Brake Balance Adjuster



Place in any hydraulic circuit to reduce pressure, maximum reduction 57%. Aluminium and steel construction. Available with handle giving 7 positive click settings or knob to allow even finer adjustment. Weight 8 oz. All but BV6 have adapters to 3/8 UNF inverted flare.

Part No	
BV2	Wilwood 6 Position Prop Valve - Tapped 1/8NPTF
BV3	Wilwood Fine Tune Knob Valve - Tapped 1/8NPTF
BV5	Tilton 7 Position - Tapped 3/8UNF
BV6	Tilton 7 Position - Tapped M10x1 Concave
BV7	Tilton Valve Knob - Tapped 3/8UNF

## Aston & Monza Filler Caps



Originally made by Enots, nobody can find the original date of manufacture of this famous range of filler caps, we have seen advertisements in magazines dating back to 1937 so they must rate as the oldest automotive components in current use. They will always be associated with famous competition cars of the sixties, twin caps on the rallying Mini Coopers, big central caps on the tails of Cobras however as in all great designs they do not look out of place on modern machinery.

Original Enots products are becoming harder to come by as some of the tooling is unserviceable. Furthermore, costs and retail prices have risen considerably. We have had new pressure die casting moulds made exclusively for us in India where casting, polishing and partial assembly takes place. Thread machining is done in the UK.

Construction: They are available in polished or chrome plated aluminium, please enquire for brass, except for the 3.5" Aston in aluminium only with either black epoxy finish or polished, We supply the caps in their vented form, but for cars used in competition which have separate breathers we can supply a conversion to non-vented (a blob of solder covering the drilled breather hole also works well).

Function: The Aston has a quick release action and was used as a fuel filler cap on most sports racing cars before dry break systems became compulsory for international racing. The catch has been simplified, but we can supply a 3.5" cap with a roller catch, (see insert), to satisfy the purists A new addition is a lower budget Aston with roller catch, built in locking cap and 2" neck. Also a 2" Aston with a 2" neck and a mounting flange. The Monza has a snap action and is used where a neater appearance was more important than split second refuelling. Both caps are also used on oil tanks, rocker covers etc.

Fitting: These caps have a threaded base and are supplied with a quantity of gaskets to adjust the orientation when screwing onto the various collars and flanges that we supply as shown on the next page. Also see lockable caps and rocker cover caps. Can be fitted to most modern small cars by utilising kits available for Aero caps.

PRE1 is a chrome plated die cast 'Mazac' cap with lock. It fits to a 2" flexible hose, as fitted to post war sports cars including Triumph, ACs.

ASTK35K



CLA200

PRE1

CAPGT40



## Dimensions

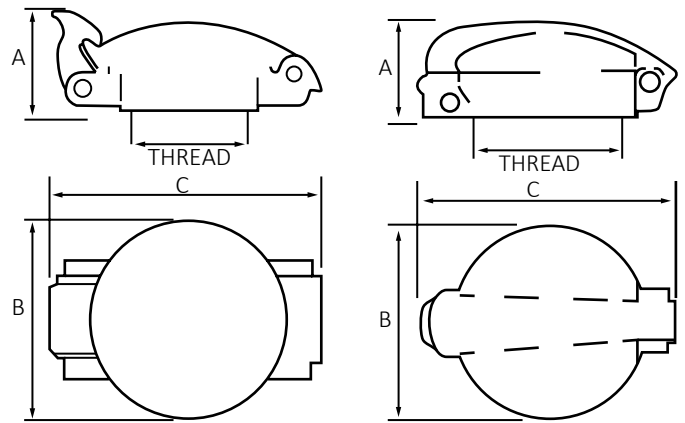

	2	2 1/2	2 3/4	3 1/2	Dimension
Aston	NA	38mm	46mm	70mm	A
	NA	76mm	87mm	122mm	B
	NA	105mm	121mm	162mm	C
	NA	2 1/2 x 16tpi	2 3/4 x 16tpi	3.93 x 11tpi	Thread*
Monza	28.6mm	31.8mm	36.5mm	NA	A
	60.3mm	76.2mm	86mm	NA	B
	82.5mm	100mm	114mm	NA	C
	2 x 18tpi	2 1/2 x 16tpi	2 3/4 x 16tpi	NA	Thread*

\*Whitworth (BSP) form

## Part No

MON2X	2.00in Monza Style Polished Aluminium
MON25X	2.50in Monza Style Polished Aluminium
MON275	2.75in Monza Style Polished Aluminium
CLA200	2.00in Aston Style Polished Ali With Flange & 2.00in Neck
AST25	2.50in Aston Style Polished Aluminium
AST275	2.75in Aston Style Polished Aluminium
AST35	3.50in Aston Polished Aluminium
AST35K	3.50in Aston Style Polished Ali Lockable, 2.00in Hose Tail
ASTR35	3.50in Aston Style Polished Aluminium, Roller Catch
AST35P	3.50in Aston Painted Black Aluminium
MONC2	2.00in Monza Chrome
MONC25	2.50in Monza Chrome
MONC275	2.75in Monza Style Chromed Aluminium
ASTC25	2.50in Aston Style Chrome
ASTC275	2.75in Aston Style Chrome
PRE1	Presto Cap Chrome

## New Classic

CLAC275

CLA300



A cap with the quick release function of the Aston with the smoother lines of the Monza. The CLAC275 fits 275 collars and flanges. The CLA300 has a bolt on fixing and is supplied with a removable locking insert and a neck to take 2" hose. OD is 100mm, length 131mm.

## Part No

CLA25	2.50in Classic Flat Cap Polished Aluminium
CLAC25	2.50in Classic Flat Cap Chrome Plated
CLAC275	2.75in Classic Flat Cap Chrome Plated
CLA300	3.00in Classic Cap - Locking Insert, For 2in Hose
CAPGT40	4.75in Original GT40 Style Fuel Filler Cap

## Rocker Cover Caps



2" Monza caps bored out to be an interference fit on the popular Minifin rocker covers. We also have threaded collars to facilitate the fitting of caps to original equipment valve covers.

Part No	
MONS2	Monza Style 2in Alloy For Minifin
MONCS2	Monza 2in Chrome For Minifin
COLAR2	Adapter Collar To Fit 2in Monza To Rover V8
COLAJ25	Adapter Collar To Fit 2.5in Monza To Jaguar XJ6

## Threaded Collars



A threaded brass collar which has a recess into which a tube can be soldered or Araldited, B) A threaded aluminium tube which can be welded or take a hose of the same bore as the thread.

Brass	
Part No	
COL2	For 2.00in Takes 1.75in OD Tube
COL25	For 2.50in Takes 2.25in OD Tube
COL275	For 2.75in Takes 2.50in OD Tube
Aluminium	
Part No	
COLA2	For 2.00in For Welding
COLA25	For 2.50in For Welding
COLA275	For 2.75in For Welding 2

## Threaded Flanges



Designed for direct fitting to tank. Part number FLAA includes nuts & bolts. Chromed are aluminium, polished & anodised are aluminium.

Chromed	
Part No	
FLAC2	For 2.00in Caps - 6 Holes X 2.5in PCD
FLAC25	For 2.50in Caps - 6 Holes X 3.0in PCD
FLAC275	For 2.75in Caps - 6 Holes X 3.0in PCD
Anodised Aluminium	
Part No	
FLAA2	For 2.00in Caps - 6 Holes X 2.5in PCD
FLAA25	For 2.50in Caps - 6 Holes X 3.0in PCD
FLAA275	For 2.75in Caps - 6 Holes X 3.0in PCD
FLAA35	For 3.50in Caps - 6 Holes X 4.5in PCD

## Aluminium Screw Cap



3½ inch flat vented cap with chain linked. The mirror polished cap allows the mounting flange to mount to the top of the body, whilst keeping it below 50mm protrusion.

Part No	
CAP3.5	3.5 Flat Vented Cap With Chain Linked, No Neck

## Threaded Flanges & Funnel



One piece threaded flange and funnel combined, designed to allow for fitment to exterior bodywork and connecting via a hose to a remote tank. They are machined from billet aluminium, polished and then anodised silver or chrome plated. Will take 2.25 (57mm) and 2 (51mm) hoses. Secondary locking filler caps (LIK1) and lead free flaps (LFF1).can be fitted.

Part No	
FLAP2	For 2.00in Caps - Takes 2in Hose -6 Holes X 2.5in PCD
FLAF25	For 2.50in Caps - 6 Holes X 3.0in PCD
FLAF275	For 2.75in Caps - 6 Holes X 3.0in PCD
FLAF35	For 3.50in Caps - 6 Holes X 4.5in PCD

## Secondary Locking Filler Caps & Lead Free Flaps



May be fitted to above (threaded flanges & funnels) except FLAP2.

Part No	
LIK1	Locking Insert Kit For All Flange/Funnel Except 2in
LIK2	As Above But Non-Vented
LFF300	Lead Free Flap Kit For All Flange/Funnel Except 2in

## Fuel Filler Neck Hose



Made from fuel resistant rubber

Part No	
NH38F	1.50in / 38mm ID Flexi Hose With Steel Spring
NH51F	2.00in / 51mm ID Flexi Hose With Steel Spring
NH57F	2.25in / 57mm ID Flexi Hose With Steel Spring
NH32NR	1.25in / 32mm ID Non-Reinforced Hose
NH38NR	1.50in / 38mm ID Non-Reinforced Hose
NH45NR	1.75in / 45mm ID Non-Reinforced Hose
NH51NR	2.00in / 51mm ID Non-Reinforced Hose
NH57NR	2.25in / 57mm ID Non-Reinforced Hose
NH63NR	2.50in / 63mm ID Non-Reinforced Hose
NH51	2.00in / 51mm ID Wrapped Hose
NH57	2.25in / 57mm ID Wrapped Hose
NH63	2.50in / 63mm ID Wrapped Hose
NH451	2.00in / 51mm ID 45° Bend
NH457	2.25in / 57mm ID 45° Bend
NH938	1.50in / 38mm ID 90° Bend
NH951	2.00in / 51mm ID 90° Bend
NH957	2.25in / 57mm ID 90° Bend

## Aluminium Screw Cap



Screw cap machined from billet with scalloped grip supplied with weld on screwed neck.

Part No	
CAP5	51mm Diameter C/W 44mm ID Neck, Polished Ali
CAP5M	As Above With <b>MOCAL</b> Logo
CAP11	44mm Dia C/W 25mm ID Neck, Polished Ali
CAP15	57mm Dia Cap C/W 46mm ID Neck, Polished Ali
CAP20	69mm Dia Cap C/W 51mm ID Neck, Polished Ali

## Radiator Caps And Necks



We can supply a full range of high pressure caps for racing use, complete cooling system should be pressure tested to maximum pressure of cap, do not use on road vehicles where cooling component failure could lead to bodily injury. Aluminium radiator necks for brazing to aluminium radiators and expansion tanks. RN1 and RN2 have 1/4" over flow, RN3 has 3/8".

### Part No

RN1	Aluminium Radiator Neck- Standard Cap Size
RN3	As Above- But 3/8In Overflow Outlet
RN2	Ali Radiator Neck - Japanese Small Cap Size
XR1	Racing Rad Cap 19-20psi
XR1L	As Above With Pressure Release Lever
XR1H	Racing Rad Cap 19-20psi Hexagonal
XR2	Racing Rad Cap 22-24psi
XR2L	As Above With Pressure Release Lever
XR2H	Racing Rad Cap 22-24psi Hexagonal
XR3	Racing Rad Cap 29-31psi
XR3H	Racing Rad Cap 29-31psi Hexagonal
XR1S	Small Racing Rad Cap 19-21psi
XR2S	Small Racing Rad Cap 22-24psi
XR3S	Small Racing Rad Cap 29-31psi

## Aero Flush Fitting Caps



Aero 200   Aero 300   Aero 400   Aero 600   Aero 500

This flush fitting cap draws its inspiration from a fuel cap used on American world war two fighter aircraft and soon appeared on Ducati motorcycles. Ferrari snapped them up for the F40 and they now grace the flanks of the worlds' leading supercars including the McLaren F1 and Jaguar XJ220. Designers of concept cars love it; Ford Indigo, Renault Sport Spider and Fifty all make a statement with the Aero cap blending beautifully with their diverse designs. The design and finish of the cap are such that it is not only the appearance that attracts but the mechanism with it's pleasing feel with a precise action.

The forged aluminium cap sits in a pressed aluminium flange sealed with fuel resistant O ring. Cap and flange are polished and anodised silver, other colours are available. Supplied with nuts, bolts and fibre gasket. Locking version has two keys. The cap was intended for in tank fitting but it is more usually mounted on the body work and connected to a fuel tank through flexible hoses. To achieve this we can supply with add on funnels in the Aero 400 series or with flanges with built in funnels in the other sizes. We have a thick rubber gasket for applications where there is slight curvature of the mounting panel, the neck of this gasket provides a secondary seal around the cap. In situations where back access is limited, we have a ring with captive nuts, the ring is slotted to allow it to be fed into holes. Where the 3" cap has to be situated within the bodywork, we can supply a rubber spill tray to which a 1/4" hose can be attached to redirect overspill. These caps are not vented, either use small vent valve or see selection of in-line or tank mounted valves on page 77.

## Dimensions

Aero Series	200	300	400		500	600
Cap Diameter	1.75"	2.25"	3"		4"	3.6"
Flange Diameter	80mm	95mm	120mm		140mm	126mm
Fixing Holes PCD	6	6	8	9	8	8
	2.5"	3"	4"	4"	4.75"	4.25"
Rubber Gasket	RUB4	RUB3	RUB1		No	No
Spill Tray	No	No	RUB2		No	No
Fixing Ring	RIN3	RIN2	RIN1		No	No
Hose I.D.	2"	2"/ 2.25"	2"	2.25"	3.5"	2"/ 2.25"
Flange & Funnel	CAP2TF	CAP2TF	No	No	No	CAP
						3500F
Separate Funnel	No	No	FUN1	FUN2	No	No
						A68NS50
						A68NS57

## Aero 200 Series 1.75" Cap



### Part No

CAP2T	1.75in Cap With 6 Hole X 2.5in PCD Flange
CAP2TF	As Above With Flange & Integral Funnel For 2in Hose
CAP2TWO	1.75in Cap With 2in Diameter Weld Stub Or Hose
RUB4	Rubber Gasket For 6 Hole X 2.5in PCD
RIN3	Ring For 6 Hole X 2.5in PCD Flange

## Aero 300 Series 2.25" Cap



### Part No

CAP2S	2.25in Cap With 6 Hole X 3in PCD Flange
CAP3S	As Above But Locking
CAP2SF	2.25in Cap With Flanged Funnel For 2in & 2.25in Hose
CAP3SF	As Above But Locking
CAP2SWO	2.25in Cap With 2in Diameter Stub For Welding Or Hose
CAP3SWO	As Above But Locking
RUB3	Rubber Gasket For 6 Hole X 3in PCD
RIN2	Ring With Captive Nuts For 6 Hole X 3in PCD

## Aero 400 Series 3" Cap



### Part No

CAP2	3in Cap With 8 Hole X 4in PCD Flange
CAP3	As Above But Locking
FUN1	Funnel & Gasket With 8 Hole X 4in PCD For 2in Hose
FUN2	Funnel & Gasket With 8 Hole X 4inpcd For 2.25in Hose
RUB1	Rubber Gasket For 8 Hole X 4in PCD
RUB2V	Rubber Gasket For 8 Hole X 4in PCD + Vent Valve
RUB2	Rubber Spill Tray - 8/9 Hole X 4in PCD
RIN1	Ring With Captive Nuts For With 8 Hole X 4in PCD
CAP2H	3in Cap With 12 Hole X 4.75in PCD Flange
CAP3H	As Above But Locking
RIN7	Ring With Captive Nuts For 12 Hole X 2.5in PCD Flange

## Aero 500 Series 4" Cap



### Part No

CAP2500	4in Cap With 12 Hole X 4.75in PCD Flange
CAP2500F	As Above With Flange & Funnel For 3.5in Hose
CAP3500	4in Locking Cap With 12 Hole X 4.75in PCD Flange
CAP3500F	As Above With Flange & Funnel For 3.5in Hose
RIN4	Ring With Captive Nuts For 12 Hole X 4.75in Flange

## Aero 600 Series 3.6" Cap



Part No	
A68S	3.6in Cap With 8 Hole X 4.25in Pcd Flange
A68L	As Above But Locking
A68NS50	As Above Not Locking With Funnel For 50mm Hose
A68NL50	As Above But Locking
A68NL57	As Above But Locking With Funnel For 58mm Hose
A68NS57	As Above But Not Locking
RING6	Ring With Captive Nuts For 6 Hole X 4.25in PCD

## Caps for Caterhams



Part No	
CAP3SCAT	2in Cap Direct Replacement On Caterham - Silver

## Caps with angled necks



Part No	
A36ANL44	A300 Locking With Angled Neck
A36ANL44K	As A36ANL44 With Retention Cable
A36ANL44LF	As A36ANL44 With Lead Free Flap
A36ANL44LFFK	As A36ANL44 With LFF & Retention Cable

Also Available In Black Finish

## Aerolook replacement filler caps



The Aerolook is available for enthusiasts who wish to achieve a similar appearance to the Aero cap without the bother of installation. This is achieved with either a one piece locking caps that replace the existing cap or a decor plate that fits over the existing cap. They are crafted from high grade aluminium with the same polished and anodised finish as the Aero. The standard finish is silver but other colours may be specified at extra cost, e.g. Black anodising is £2.00 extra.

Part No	
CAPVW1	Silver Cap For Volkswagen Golf MK1 - 1977 On
CAPVW1V	Silver Cap For Volkswagen Golf MK1 - 1974-76
CAPNOVA1	Silver Cap For Vauxhall Nova & Astra MK1/2
CAPCLIO	Silver Cap For Renault Cleo Phase 1 Up To 94
CAPPEU205	Silver Cap For Peugeot 205
CAPPEU206	Silver Decor Plate For Peugeot 206
CAPFORD1	Silver Decor Plate For MK3 Escort

## Smarty Flush Cap



An economically priced two piece cap with flange and funnel, Construction: 50mm diameter polished aluminium flange and funnel to take 2" bore hose with mainly plastic locking cap insert.

Part No	
CAP3ZF	Locking Cap - Flange & Funnel
CAP3ZFV	As Above But Vented

## Tank Breather Valves



A range of fuel tank valves that allows air in to replace fuel used, air out due to heat expansion and a positive shut off to prevent fuel escape, due to splashing or even roll over. This is achieved by a two ball system, one hollow plastic, one solid steel.

**TBV45:** A very small valve mainly used with our range of fuel caps when fitted direct to tanks it fits a 5/16in (8mm) hole, replacing a fixing screw, we can provide a specially machined cap flange. Takes 1/8bore hose.

**TRV45:** For fitting to tank through a 7/16in (11mm) hole. Access from inside the tank is required. Vertical vent pipe takes 1/4 bore hose.

**THV45:** As above but with a horizontal vent pipe.

**TRV67:** As above, but requires 9/16in (14mm) hole. The body has a 9/16UNF thread, which can be bolted from underneath, or threaded into a weld on nut. Takes 1/4in hose.

**TRV86:** The large valve for serious gas guzzlers. The body has a 3/4UNF thread, which can be bolted from underneath, or threaded into a weld on nut. Vent takes -6 JIC female fitting.

**TRL7:** For in line fitting into 1/4in bore hose, must be mounted vertically.

Part No	
TBV45	Small Vent Valve
TRV45	Medium Vent Valve
THV45	Medium Vent Valve - Horizontal Outlet
TRV67	Large Vent Valve
TRV86	Maximum Flow Vent Valve
TRL7	1/4in Push On X 1/4in Push On In Line Valve
TRL6	-6JIC X -6JIC In Line Valve
TRL8	-6JIC X 1/4in Push On In Line Valve
TRL68	Tank Rollover Breather -6 JIC Male X 8mm Push On
ROV2-6-65	Roll Over Valve Female M16 X -6JIC
ROV2-65	Roll Over Valve Female M16 Krontec
ROV2-65+	Roll Over Valve Female M16 Female
ROV7-6	Roll Over Valve -6JIC Krontec
ROV7-6+	Roll Over Valve -6JIC 200 millibar FIA Compliant
ROV7-8	Roll Over Valve -8JIC Krontec
ROV7-10	Roll Over Valve -10JIC Krontec
ROV7-12	Roll Over Valve -12JIC Male
VRJ6-6	Roll Over Valve -6JIC 200 millibar FIA Compliant
VRJ6-8PP	Roll Over Valve -6JIC X 3/4UNF 90° FIA Compliant
VRM16-6	Roll Over Valve M16 X -6JIC 200 millibar FIA Compliant

## Fuel Tank Caps For Superbikes



Direct replacement for original equipment. They have a locking facility but may be used as a quick release cap for race refuelling rigs including the Acerbis system. They are manufactured from billet aluminium and polished and anodised silver. As with other caps in this range they are a delight to feel and operate and have the stunning looks achieved when form and function harmoniously combine. Eminently suitable for race and road.

Part No	
SB3LHO	Honda To 2003
SB3LKA	Kawasaki To 2000
SB3LSU	Suzuki To 2003
SB3LSU/03	Suzuki From 2003
SB3LTR	Triumph
SB3LYA/DU	Yamaha/Ducati



## Quick Fill Refuelling Equipment

A new range of refuelling equipment with push pull connections in accordance with FIA appendix J drawing 252-5. There are fully floating spindles on the female fitting to give a smooth action and avoid sticking.

The vehicle will require 2 female connections, one to fill and one to vent. Conversely the refuelling rig will require two male connections one feeding from a main supply tank and one for venting to a bottle or tank. We can also supply twin females in a side by side configuration with 100mm centres, also handles to take males at the same spacing. For non FIA situations the bottle can be used as a fuel churn with one male fill connection in which case the vehicle should have a one way quick release valve venting to top of the bottle.

We are constantly adding to and revising this range so please enquire before ordering.

### Female Quick Fills



Part No	Description
QF250	Remote Female Valve With Flange 57mm Hose Tail
QFR252	As Above But Twin Side By Side Installation
QFF250C	As QF250 With M50x1.5 Tail Fits ATL Caterham Cell
QFT251	Tank Mounting Female Valve
QFT252	Double Tank Mounting Female Valve
QF250CF	Single Conversion Flange

### Male Quick Fills Bottles & Systems



Part No	Description
CAR1	Fuel Bottle 25L Use As Vent Catch Tank Or Filler
STA1	Stand For CAR1 Fuel Bottle
QFM250TF	Filler Flange With Cap For CAR1 Has 1in Return
QF250TNA	2.25in Hose Tail Screw Attachment For CAR1
QFB1	Bottle Assembly Using All Three Above
QM251	Male Valve With 2.25in Hose Tail
RE-AG-003	Male ATL Valve With 2.25in Hose Tail
QMH252	Handle For 2 QFM2s For Twin Side By Side; Horizontal
QMV252	As Above But Vertical
QFMAN	Dual Feed Manifold
QFMAN45	As Above But Angled At 45°
QFMAN80	As Above But Angled At 80°
QFBC1	Thermally Insulated Cover

### Male Quick Fill assembly

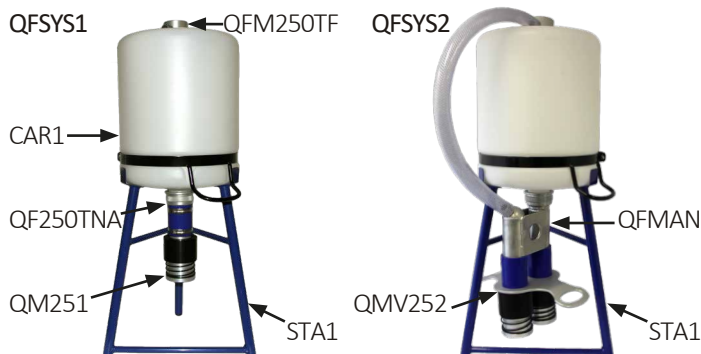

Part No	Description
QFSYS1	Complete Bottle Assembly With Single Male Valve
QFSYS2	Complete Bottle Assembly With Twin Male Valves

## Air Jack System

### Air Jacks



We offer the Krontec range of quick lift, built in air jacks, All aluminium, latest springless technology. Most usually mounted on the rollcage, operated by compressed air from a bottle two sizes with a standard 230mm stroke, specials are available. Supplied with mounting nut and -6JIC air fitting. Not interchangeable with AP racing products.

Part No	Mounting Thread DIA	Weight in Grams	Lift Capacity at Various Pressures		
			40 bar	30 bar	20 bar
LL - 22	M60 x 1.5	962	750kg	562kg	375kg
LL - 32	M50 x 1.5	808	488kg	366kg	244kg

Part No	Description
LL-22	60mm Diameter Air Jack
LL-32	50mm Diameter Air Jack

### Air Connections

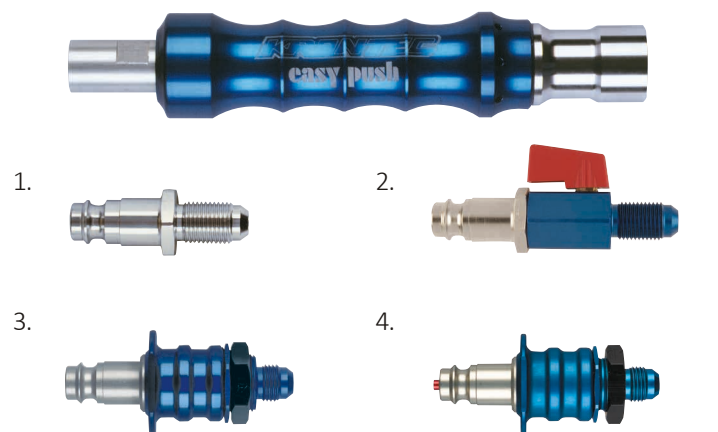

The 4 or 3 jacks are usually plumbed with rigid aluminium tube, see page 52, to an easily accessible body mounted connection valve. A "lance" or "wand" attached to a flexible hose supplied with compressed air will, with the lightest of pushes, fasten on to the connection valve and up goes the car. Your choice of valve will dictate how it comes down

1. LL-12: Air stays in the system until lance is disconnected.
2. LL-13: Tap can be closed after connection, air stays in system until lance is disconnected and tap is opened.
3. LL16: Air stays in system until lance is disconnected and sleeve is slid to open.
4. LL16plus: As above but air can be slowly released by operating button, as when lowering onto axle stands.

Part No	Description
LL-03	Easy-Push Air Lance
LL-12	On Car Connector -6JIC
LL-13	On Car Connector With Tap -6JIC
LL-16	On Car Connector Sleeve Release -6JIC
LL-16PLUS	As Above With Slow Release Button

## Safety Props And Car Lifter



No work under the car should take place without safety props in place, in case of accidental release. The car lifter may be used in place of safety prop and used to provide extra height under the car. To use: Raise car, insert lifter, lower car, insert bar in lifter, raise car.

Part No	
LL-90	Safety Prop For 60mm Jack
LL-91	Safety Prop For 50mm Jack
LL-20CL	Car Lifter For 60mm Jack
LL-30CL	Car Lifter For 50mm Jack

## Electric Fuel Pumps, Regulators & Filters

The pumps are used as cost effective replacements for existing pumps, both mechanical and electrical, for back up systems and in new installations. Pumps should be mounted as low and as near to the fuel tank as possible, all pumps are more efficient when they are pushing not pulling, the solid state should not be mounted more than 12" above fuel level. Pumps should be rubber mounted if quietness of operation is desirable. Regulators should be mounted as near to carburettors as possible.

Connecting pumps in series, i.e. the outlet of the first pump feeding the inlet of the second pump doubles the pressure. Connecting in parallel both inlets drawing from a common source and outlets feeding one pipe will double the flow. Construction: Facet pumps have plunger operation, Holley & Weldon pumps have rotary sliding vanes. The solid state pump is sealed for life and has no built in filter, the others have replaceable parts including filters that may be removed for cleaning.

Performance: See chart below

PUMP	Flow in litres/UK gals per hour	Pressure	Ports
Holley 12 - 802	420/92 freeflow, 265/58 at 9psi	14psi	3/8 NPTF
Holley 12 - 801	370/81 freeflow, 255/56 at 5psi	7psi	3/8 NPTF
Holley 12 - 815	530/116 freeflow, 415/92 at 9psi	14psi	3/8 NPTF
Facet Solid State	115/25 freeflow	3.5psi	1/8 NPTF
Facet Silver Top	135/30 freeflow	5psi	1/8 NPTF
Facet Red/Blue	170/37 freeflow	7.5psi	1/4 NPTF
Weldon WFP1	320/60 at 70psi	70psi	-8JIC
Weldon WFP2	415/90 at 10psi, 410/70 at 160psi	160psi	-8JIC
Weldon WFP3	680/150 at 5psi, 530/116 at 80psi	80psi	-8JIC
Bosch BO979	165/37 freeflow	75psi	M14/M12
Bosh BO044	200/45 freeflow	75psi	M18/M12

## Facet (Bendix) Pumps



Silver/Blue/Red top



Solid State

The red top has a more restrictive (finer) filter than the blue top otherwise they have the same specification.

Part No	
FSS1	Solid State Facet No 40105
FST1	Silver Top Facet No 476086
FBT1	Blue Top Facet No 480534
FRT1	Red Top Facet No 480532
FMK1	Rubber Mount Kit

See pages 46 - 47 for fittings for oil & fuel hoses

Filters For Facet Pumps	
Part No	
FF8-3-5	For Solid State To 5/16in ID Hose
FF74	74 Micron For Silver/Red Tops
FF400	400 Micron For Blue Top

## Weldon Pumps & Regulator



WFP1

WFP2

WFP3

WFR1

The finest fuel pumps for super high performance with 13 different pumps for engines making 600 to 2400 horse power, we stock 3. Billet aluminium bodies with steel/bronze internals, breakaway motor to pump coupling prevents damage from fuel contamination. No internal filters fitted. Use with regulator except WFP1 which has internal valve and cast body. The regulator has 2 x 1/8NPTF ports for gauge and boost sensor.

Part No	
WFP1	Fuel Pump With Built In Pressure Relief Valve
WFP2	Fuel Pump D2015-A
WFP3	Fuel Pump D2025-A
WFR2	Return To Tank Regulator -10JIC Ports, 4 To 200psi
WFR3	Fuel Regulator #A2040 Upto 120psi

## Holley Pumps

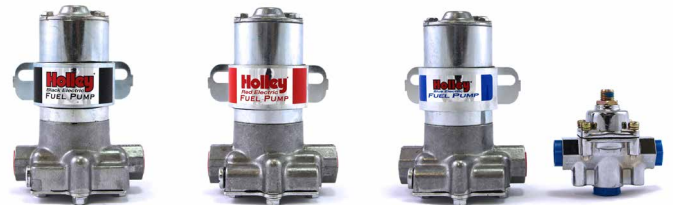

H8151

H801

H802

All have a cast aluminium body with 3/8NPTF ports.

Part No	
H802	12-802 - Blue, Supplied With Regulator
H812	12-802 - Blue, Supplied Without Regulator
H801	12-801 - Red, Supplied Without Regulator
H8151	12-815 - Black, No Regulator

## Holley Regulator

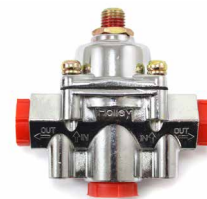

It has a painted aluminium body with three 3/8 NPTF female ports, one inlet and two outlets one of which may be blanked if not required or used as a tapping for a fuel pressure gauge / indicator.

Part No	
H803	12-803 - 4.5 To 9psi - Holley Regulator
H804	12-804 - 1 To 4psi - Holley Regulator
H803BP	Holly Regulator 4.5 - 9psi Bypass

## Low pressure Regulator



Chromed alloy body with 1/8NPTF female threads, supplied with 1/4", 5/16" and 3/8" fittings. Can be set from 1-5psi on calibrated dial.

Part No	Regulator 1-5psi to suit 1/4", 5/16" and 3/8" Hose
PRO50	

## Petrol King Pressure Regulator



Although much touted as fuel saving gadget, it is a proper fuel pressure regulator for carburettors, set at 2psi but adjustable it should be set up with a pressure gauge in accordance with carburettor manufacturers' recommendation. Incoming pressure not above 10psi. The body is pressure die cast aluminium with neoprene membrane suitable for most fuels except methanol, adjustment 1.5-5psi. Inlet & outlet ports are tapped. 1/8 NPTF, supplied with 5/16" straight connectors

Part No	Tapped 1/8NPTF - With 5/16in Connectors
FR-5	

## Filter King Fuel Pressure Adjuster & Filter



As pressure regulator but with filter, Highflow has aluminium bowl and washable metal filter and 1/8NPTF tapping for pressure gauge take off. The others have glass bowls.

Part No	Highflow 140mm High With -6JIC Male Connections
FK2	
FK5	Highflow 140mm High With 5/16in Hose Tails
FK1	140mm High With 5/16in Hose Tails
FKS1	120mm High With 1/4 & 5/16in Hose Tails

## MOCAL Filter



The two part threaded anodised aluminium housing in standard blue, black, red or silver. Removable stainless steel filter, which can be cleaned. Choice of 15, 40 or 120 micron mesh. Essential on fuel systems to protect carburettor and fuel injection pumps. Can be supplied in 2 different halves, e.g. to join -6 to -8 hose. Negligible pressure drop when clean but must be inspected regularly.

Add suffix 15, 40 or 120 for mesh size then add suffix B for black, R for red, C for silver e.g. SLF7-6-120C has 120 filter and silver body. 15 Micron filter increases cost.

Part No	
SLF7-4	-4JIC In Line Filter
SLF7-6	-6JIC Male Unions
SLF7-8	-8JIC Male Unions
SLF14-5	To Fit 5/16in ID Hoses
SLF14-6	To Fit 3/8in ID Hoses

## Pro-Filter



Construction: Chrome plated steel end caps, glass housing with 40 micron plastic filter which may be removed for cleaning.  
Application: Use on carburettor systems, not above 10psi.

Part No	Push On For 1/4in ID Hose
PRO804	
PRO805	Push On For 5/16in ID Hose
PRO806	Push On For 3/8in ID Hose

## Filters For Electric Pumps



Low restriction oil filter, 240 micron, designed to protect electric pumps used in transmission, differential or turbo charger installations from damage to gears or soft diaphragms. Body is black anodised aluminium and the element is cleanable wire mesh. Dimensions are 160mm long x 45mm diameter.

Part No	
ILF7-6-10	-6JIC In Line Filter 10 M
ILF7-6-100	-6JIC In Line Filter 100 M
ILF7-6-240	-6JIC In Line Filter 240 M
ILF7-8-10	-8JIC In Line Filter 10 M
ILF7-8-100	-8JIC In Line Filter 100 M
ILF7-8-240	-8JIC In Line Filter 240 M

## Electric Fuel Pumps For Fuel Injection



Bosch pumps have steel bodies 168 x 60mm x with M14 x 1.5 or M18x1.5 intake, M12 x 1.5 outlet, pressure 5Bar. Max current 10amps, weight 1kg approx. We can supply a blanking cap to allow a banjo fitting to be fitted to outlet.

Part No	
BO979	165 Litres/Hour M14 Inlet
BO044	200 Litres/Hour M18 Inlet
CPH1	Carbon Fibre Holding Bracket For Above
FPH3	Fuel Pump Holder By Sytec Billet Alloy
FPH4	Fuel Pump Holder <b>MOCAL</b> For Bosch Billet Alloy
BCA2-45B	M12x1.5 BlankingCap/Banjo Retainer
BOF5021	Bosch Fuel Filter M14 X M12 Female/Female
BOF5907	Bosch Fuel Filter M16 Male/Female

## Electric Oil Pumps

Used in oil cooler installations for manual gearboxes and differentials. In turbo charger installations for pre-oiling and to provide a flow of oil after shutdown or to scavenge oil from the turbo charger. Electric pumps can be used when the vehicle is stationary, when extra cooling/lubrication is often most needed.

Installation. Cooler installations are usually plumbed in -6 or -8 hoses. For transmissions, operate only when oil has reached at least 70°C as cold oil will not pump. Pump and cooler must be mounted below gearbox/differential oil level to avoid over filling when switched off. Cold oil return should be after point of gear engagement to reduce pumping losses.

Turbo charges feed installations normally draw oil from sump and supply is teed into existing feed pipe with a check valve. In addition to the pumps below, the Holley fuel pump has been used successfully where weight is the most important factor. In transmission cooling applications we advise a low restriction filter to avoid pump damage.

### Jabsco Oil Cooling Pump



Construction: 12 or 24 volt electric motor with brass pump housing and neoprene impeller, although rated for modest temperatures has proved satisfactory for elevated temperatures encountered. We recommend that an extra impeller housing gasket be fitted for temperatures above 90°C. Weight 3kg. Ports are 1/2 BSP. These pumps were widely used in the early '60s, so good for historics.

Part No	
JP-1	Jabsco Pump 12V 450gph (1950lph)
JP-2	Jabsco Pump 24V 12V 450gph (1950lph)
JP-5	Jabsco Pump 12V 105gph (420lph)
JPI-1	Spare Impellor JP-1&2
JPG-1	Impellor Housing Gasket JP-1&2

### MOCAL Oil Cooling Diaphragm Pump



A diaphragm pump, has integral cooling fan, 12 volt motor. Weight 1.5kg. Ports are 3/8NPTF and may be rotated in 90° increments to simplify plumbing. The pump body is made of lightweight nylon. Care must be taken when tightening tapered adapters so not to over tighten and crack housing.

Performance: Flow 1.6 gals/7.5 litres per min. Pressure 50psi/3.5 bar. Temperature, for constant use up to 130°C, intermittent up to 150°C. Max current draw 5 amps.

#### Dimensions

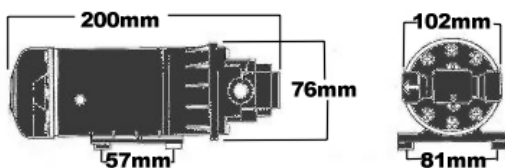

Part No	
TCP1	<b>MOCAL</b> Pump 12 Volt
TCP3	<b>MOCAL</b> Pump 24 Volt
TCP240VOLTS	<b>MOCAL</b> Pump 240 Volt

We can also supply various spare parts for the TCP range of pumps including a Diaphragm kit which is perhaps the most vulnerable element in the pump.

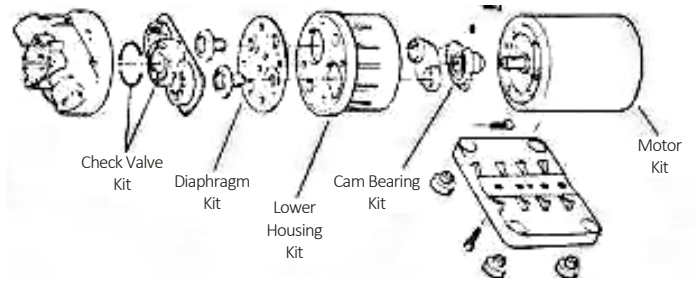

Part No	
OPP2	TCP Fan Shroud Kit
OPP6	TCP Diaphragm Kit (Viton)
OPP6B	TCP Diaphragm Kit (Buna)
OPP7	TCP Check Valve Kit
OPP10	TCP Base Plate
OPP16	TCP Pump Head Housing

### Weldon Oil Cooling Pump



A sliding vane pump built to close tolerance aerospace standards. 14 volt motor. Weight 1.4kg/3lbs. Ports are -6JIC (9/16 X 18TPI) female. The pump body is machined from billet aluminium, rotating parts are heat treated high speed steel in precision bearings. Adjustable cam ring for varying pressure/flow. Built in pressure relief valve. Performance: Flow 24 gals (UK)/109 litres per hour of oil at 150°C. Pressure 0-60psi/0-4bar. Temperature for constant use up to 150°C. Max current draw 5.5 amps.

#### Dimensions

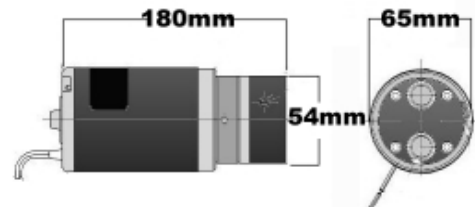

Part No	
WCP1	Weldon 9200A Oil Pump
WCP1B	Quick Release Bracket
WCP1C	Weldon Electrical Connector

### Weldon Oil Lubricating Pump



Construction is similar to above but more suited to lubricating under pressure. Adjustable pressure relief valve. Flow 16 gals (UK)/75 litres per hour at 25psi.

#### Dimensions

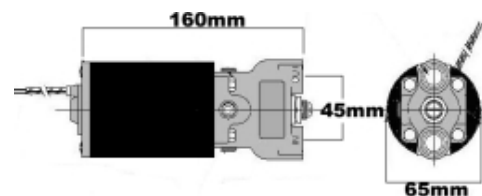

Part No	
WLP1	Lubricating Pump (Use WCP1B Bracket)

## MOCAL Oil Cooling Gear Pump



Hardened bronze gear pump. Brass body 12 volt motor. Weight 1.361kg. Flows up to 150 gph (UK) 680 litres ph of oil pressure up to 50psi. Max temp 175°C. Current draw 6 to 8 amps. Rubber mounted.

### Dimensions

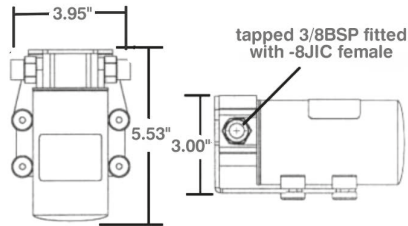

Part No	
EOP2	Electric Oil Pump - Gear Pump 12 Volt
EOP2-24	Electric Oil Pump - Gear Pump 24 Volt
EOP2-FEET	Mounting Feet - EOP2 Pack of 4

## Turbo Drain Pumps



TDP1

TDP2

Heavy duty pump to cope with high temperature and continuous use. Both have 3/8NPT ports, will work to 175°C and have 10 000 hour rated bearings and motor bushes. TDP1 can flow 3.6 - 11 LPM to 3.4bar max pressure. TDP2 can flow 3.6 - 7.3 LPM to 2bar max pressure. Full spec and dimensions available on request.

Part No	
TDP1	Turbo Drain Scavenge Pump Large
TDP2	Turbo Drain Scavenge Pump Small

## Thermal Switches

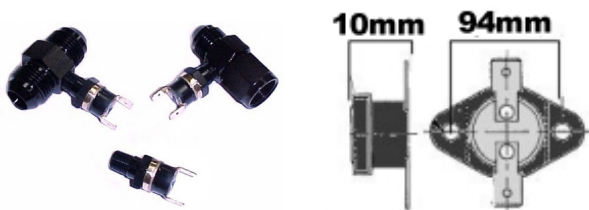

Control pump action. EWS/1G is a two pole surface mounted switch with two screw holes, connect into earth line, makes on the rise at 100°C and breaks on the fall at 82°C.

Part No	
EWS/1G	Surface Mounted Switch Makes At 100 °C
FS82	Fan switch 82° 1/8 NPT Male thread
FS88	Fan switch 88° 1/8 NPT Male thread
MFFA8-6-6-3	-6AN Male/Female to suit FS82/88 above
FBM2183	-6AN Male/Male to suit FS82/88 above
MFFA8-8-8-3	-8AN Male/Female to suit FS82/88 above
FBM2184	-8AN Male/Male to suit FS82/88 above
MFFA8-10-10-3	-10AN Male/Female to suit FS82/88 above

## Electric Water Coolant Circulation Pumps

EWP®



This exciting concept offers more available engine power, better mpg, improved cooling with quicker warm up and longer engine life. It is supplied in kit form to replace existing belt driven water pumps. Owners of older cars with troublesome original pumps have also achieved new found cooling reliability.

The existing belt driven pump is inefficient in that to allow sufficient circulation at low speed, the flow generated at medium to high speeds is not required and is wasteful of engine power as is the energy required to speed up a mass of water through a restrictive radiator during hard acceleration. Water circulation ceases on turn off and engines are often cooked by switching off after a high speed run.

The water pump should be connected into the bottom hose, use the adapters to suit various hose diameters. Disconnect the existing pump pulley and use a shorter belt, the idling pump will offer no resistance to flow. Or the old impeller may be removed from the shaft. However it can be beneficial to run both pumps. Set a thermal switch to slightly less than desired running temperature so that the pump will boost when required.

An adjustable electronic controller supplies exact voltage to govern water pump speed to achieve desired cooling requirements, a pulsing flow for the first 10°C then increasing steady flow over the next 10°C has digital temperature setting, 2 minute run on after switch off, diagnostics to identify cooling problems, monitoring to indicate operating mode. 12amp capability.



Mount under the dashboard where adjustment dial can be reached, all wiring and connectors are supplied. The temperature sensor is a thin flexible rod which can be inserted into the existing thermostat housing. Thermostat itself is removed or fitted into a TGA5 (see next page). Wiring on battery side of ignition switch will allow pump to run on. Comprehensive instructions & wiring diagrams are supplied. For short duration racing where no alternator is used and current used is of no significance an adjustable thermal or on/off switch may be used.

For serious competitors the ability to tailor flow will enable redesign of the entire cooling system resulting in smaller radiators with obvious advantages. For all competitors taping up radiators to achieve correct temperatures will be a thing of the past.

Three sizes are offered EWP1 (EWP80) will pump up to 80 LPM and suit naturally aspirated and turbo charged engines up to 3 litres. The EWP115 will pump up to 115 LPM and suit large 6 cylinder and V8 engines, heavy duty 4WD and most engines over 400hp. The EWP150 will pump to 150 LPM to cope with even more demanding applications.

Part No	
EWPC3	Electric Water Pump Controller

## EWP1 (EWP80)

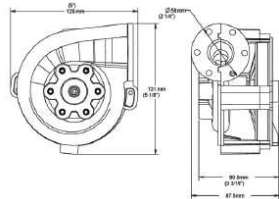

### Part No

EWP1 Electric Water Pump 12V 80lpm Nylon Body

## EWP115

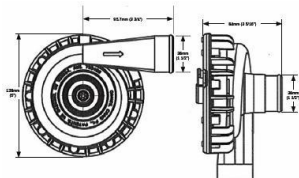

### Part No

EWP115 Electric Water Pump 12V 115lpm Nylon Body  
 EWP115ALLOY As Above But Aluminium Body  
 EWP115C Combined Pack EWP115 & EWPC2  
 EWP115CALLOY As Above But Alloy Pump  
 EWP11524V Electric Water Pump 24V 115lpm Nylon Body  
 EWP11524VALLOY EWP 24V 115lpm Aluminium Body

## EWP150

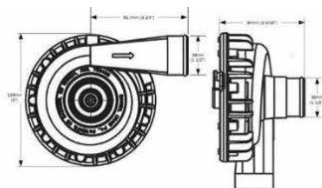

### Part No

EWP150A EWP 12V 150lpm Aluminium Body  
 EWP150A24V EWP 24V 150lpm Aluminium Body  
 EWP150AC Combined Pack EWP150A & EWPC2

The pumps come with a range of sleeves to adjust the O.D. of the hose connector. The aluminium versions of the EWP115 & EWP150 are also tapped internally -16 to take a male/male adaptor. We can supply adaptors on request.

	EWP1 (EWP80)	EWP115	EWP115 Alloy	EWP150
Flow	80 Lpm	115 Lpm	115 Lpm	150 Lpm
Max Pressure	50 psi	72.5 psi	72.5 psi	72.5 psi
Temperature Range	-20 to +130°C	-40 to +130°C	-40 to +130°C	-40 to +130°C
Max Current	7.5 amps	10 amps	10 amps	10 amps
Weight	900 grams	980 grams	1151 grams	1170 grams
Hose Size	32 - 51mm	38 - 51mm	38 - 51mm also tapped AN16	38 - 51mm also tapped AN16

## Small Coolant Circulation Pump



Construction: 12 or 24 volt brushless motor connected to impeller in nylon housing via magnetic coupling. Overall length 97mm, Overall diameter 69mm, weight 0.25kg, has 3/4" push on connections. Performance: 13.3 litres/min at 0.12 Bar (1.7psi), current draw 0.7amp (12v). Temperature range -40 to 135°C. For users of the EWP/1 & 115 this pump can operate on the heater circuit for constant heater supply or in LPG installations requiring a heated manifold. Also used for water circulation on water to charge intercoolers. Water cooling on small capacity engines. Water cooling for brakes.

### Part No

EWP004 12V Circulation Pump

## DIGITAL GAUGE THERMATIC® FAN / EWP SWITCH KIT **NEW TO CATALOGUE!**



The Digital Gauge Thematic Fan/EWP 12V Switch automatically activates single or twin fans or a fan and Electric water pump at your set / targeted temperature when extra cooling is required. It can also detect transmission fluid temperature.

### Part No

EWPC0500 Digital Gauge Fan/EWP Switch

## Electric Fans



The concept of the electric fan as a replacement for the mechanical fan is well established. Because it is not running all the time it saves power also it is more controllable, for instance, it can be run after engine switch off, especially in conjunction with an electric pump to avoid damaging heat build-up. Davies Craig fans have been at the forefront of electric fan cooling from the inception and are fully developed with a quiet and highly efficient blade design which together with the high quality Panasonic motor provides an excellent package. To suit different installations the blade and motor polarity are reversible to change from pulling air through the radiator to pushing.

The short fan assembly consists of blade, motor and shroud. The kit assembly consists of blade, motor and shroud together with wiring, relay, mounting hardware and instructions. Fans may be attached directly to the radiator using nylon ties.

There are three switching options.

1. The fans may be automatically activated by the DCFS switch, adjustable from 80 to 115°C and driven by a mechanical sensor, connected via a capillary tube, inserted between the radiator hose and radiator outlet pipe or into the new in hose adapter TGA5. This adapter will also accept any other 1/4" or 6mm sensor or 1/4 BSPT male thread and fit 30-42mm hoses, please ask if you require bigger.



TGA5

2. The DCFSE switch adjustable from 85 to 100°C driven by a sensor placed in the radiator finning, connected electrically, this unit has a built in relay allowing for an air conditioning override.
3. The DCFSNE switch as above but piggy-backed on to an existing temperature gauge sensor, the temperature at which the fan cuts in is still adjustable.

We stock 12 volt fans, 24 volt are available as are a full range of spares, prices on request. Fans are warranted for 2 years or 1500 hours, whichever is the lesser, against faulty workmanship and materials.

## Fan Dimensions & Performance

Part No	DCF 08	DCF 09	DCF 10	DCF 10X	DCF 12	DCF 14	DCF 16
Height in mm	213	242	270	275	293	350	400
Width in mm	213	249	290	278	293	348	424
Depth in mm	52	55	64	50	51	76	100
Weight in Kg	0.88	0.93	1.13	1.13	1.45	1.5	3
Max air flow in Litres per second	200	280	350	325	400	500	1000
Max current in amps	5	6.5	7	7	9	11	19
Suggested max engine size in litres	1	1.5	2.5	2.5	3	3.5	5



FAN115

Part No.	
DCF08	8in Fan Short Assembly 12V
DCF09	9in Fan Short Assembly 12V
DCF10	10in Fan Short Assembly 12V
DCF10X	10in Fan Short Assembly 12V Slim
DCF12	12in Fan Short Assembly 12V
DCF14	14in Fan Short Assembly
DCF16	16in Fan Short Assembly 12V
DCFK08	8in Fan Kit Assembly 12V
DCFK09	9in Fan Kit Assembly 12V
DCFK10	10in Fan Kit Assembly 12V
DCFK10X	10in Fan Kit Assembly 12V Slim
DCFK12	12in Fan Kit Assembly 12V
DCFK14	14in Fan Kit Assembly 12V
DCFK16	16in Fan Kit Assembly 12V
FAN96B	12Volt Electric Fan 96mm Diameter Blow
FAN96S	12Volt Electric Fan 96mm Diameter Suck
FAN115B	12Volt Electric Fan 115mm Diameter Blow
FAN115S	12Volt Electric Fan 115mm Diameter Suck
FAN167S	Electric fan 167mm Diameter Suck
DCFS	Mechanical Switch
DCFSE	Electronic Switch From Fin Sensor
TGA5	In Line Adapter 1/4BSPT X 30-42mm Hose
DCFMK	Plastic Mounting Feet For DC Range Pack Of 4
DCQFK	Nylon Ties For Through Radiator Mounting

## In Line Blowing Fan



In line blower fan. Lightweight, high output fan ideal for driver and cockpit cooling, brake cooling or for use with cooler ducts for remote cooler mounting. 76mm inlet/outlet.

Part No	
ILBF-M76	In Line Blowing Fan 76mm

## Micro Heater 12V



A small and light hot water based heater designed for race and rally cars. These work with one or two universal defrost vents which feed the windscreen. A complete solution for the heater with hose and fluids, weighs under 2kg. The heater matrix can be mounted with the hose fittings facing towards or away from the 2.5" outlet.

Part No	
HEAMH1	2.2KW Micro Heater 12V

## True Y



A push on adapter for 63.5mm heater ducting.

Part No	
HEAY-M63	M63 Push On True Y

## Lightweight Heater 12V



Suited to vehicles where lightweight and compactness are of the utmost importance without sacrificing heat output. Using a space saving axial fan and an efficient copper heater matrix it offers heater performance normally delivered by units twice its size.

Part No	
HEALH1	3.5KW Lightweight Heater 12V

## Round Air Vents



A directional air vent. These are extremely durable making them suitable for numerous applications. The vents can be rotated to direct air where needed, or closed off completely to increase air flow to the rest of the system.

Part No	
HEAV-M51	Round Air Vent 2"
HEAV-M63	Round Air Vent 2.5"

## 2.5" - 2" Adapter



Part No	
HEAJ-M51-M63	2.5" - 2" Adapter

## Defrost Vent 2.5"



A universal defrost vent made from high strength ABS plastic. Internal directional flutes provide a wide distribution of air flow. These can be installed into vehicles without a dash panel by using the mounting holes on the side of the vents. A vent top is included for the interior appearance. No screws are supplied.

Part No	
HEADV-M51	Defrost Vent 2"
HEADV-M63	Defrost Vent 2.5"



## Oil Pressure Accumulators, Accusump

This device consists of a piston in a cylinder with air in the chamber behind the piston pre-pressurised to 6psi, engine oil pressure further compresses the air providing the means to store oil at normal engine operating pressure. A choice of sizes is available, the maximum oil flow through an engine varies from 2 gallons (9 litres or 16 pints) per minute to 12 gallons (54.5 litres or 96 pints) per minute, therefore a 6 pint accumulator could give from 22 to 4 seconds protection, usually much longer at lower rpm. A 2 pint accumulator would be adequate at cranking speeds. Capacity could be increased by mounting an extra air reservoir in tandem.



### Application:

1. To provide oil to the engine when the oil pump is unable to pick up oil from the sump due to conditions of surge during acceleration, braking or cornering.
2. To provide pre-lubrication to the engine when starting before oil pump has built up pressure. Cold starts account for 80% of engine wear.
3. To iron out shock waves in the oil pressure system, caused by rapid rpm increase on a cold engine, sticky oil pressure relief valves, etc. Shock waves can damage oil filters, coolers, oil lines and oil pump drives.
4. To provide more engine power by lowering the level of oil in the sump thereby reducing crankshaft windage, the correct levels can only be achieved by experimentation and is best left to experts.

**Construction:** The main body is built from 4.1/4"x 1/8" wall aluminium tubing, roller burnished and hard Teflon coated with aluminium O-ringed end caps and piston. Has 0-160 psi gauge, a Schrader valve for air pre-charge.

### Installation:

1. The accumulator may be mounted in any position, various methods of plumbing in may be used. Straight into oil gallery provides the simplest method but usually the only available tapping is the oil pressure switch/sender which is too small to allow full pressure to be restored, ideally tap the block when the engine is stripped. When pre-lubricating, an oil filter with an anti-drain valve (most filters have one) will prevent oil flowing back to the sump through the oil pump.
2. For engines with spin on filters, use a **MOCAL** take off plate between filter head and engine, modified with a non-return valve and one port blanked off SPV1 etc. See page 20 for fitting chart. Discard the V suffix when reading chart.



3. For engines with a disposable element filter use a standard take off plate Tee off a loop and fit a one way valve, see page 69 or Accusump check valve ACCUV2, to prevent oil returning through the pump.



4. Tee off downstream of a remote filter installation. This gives full flow and protection from flowback through the pump if a filter with anti drain valve is fitted.



### Choice of valves:

The accumulator will operate automatically when installed, filling and discharging as pressure varies. However to take advantage of the pre-lubing a valve must close off the accumulator at full pressure when the engine is switched off and turned on prior to starting this may be done manually if the accumulator is mounted within reach of the driver if the manual control valve is inaccessible we can provide a well engineered cable operation.

An electric valve may be switched or actuated by the ignition circuit. A new development is the E.P.C switch a combination of the electric valve and an electronic switch which only allows oil to flow into the accumulator when a chosen engine oil pressure is reached, however it allows flow to the engine when oil pressure drops below the chosen setting. This is of benefit in that the restored oil pressure will only go to the accumulator when the engine is being fully lubricated e.g. after a long corner the accumulator may be empty, when the track straightens out all the flow will go to the bearings instead of being shared with the accumulator.



Accusumps complete with manual or electric valve.

Part No	
ACCU5	12in Long- 3.25in Diameter 2 Pint - Manual Control
ACCU5E	12in Long- 3.25in Diameter 2 Pint - Electric Control
ACCU1	12in Long- 4.25in Diameter 4 Pint - Manual Control
ACCU1E	12in Long- 4.25in Diameter 4 Pint - Electric Control
ACCU2	16in Long- 4.25in Diameter 6 Pint - Manual Control
ACCU2E	16in Long- 4.25in Diameter 6 Pint - Electric Control

To use the EPC valve, choose an accusump a without valve.

ACCU5A	12in Long- 3.25in Diameter 2 Pint - No Valve
ACCU1A	12in Long- 4.25in Diameter 4 Pint - No Valve
ACCU2A	16in Long- 4.25in Diameter 6 Pint - No Valve

Then add your choice of EPC valve.

ACCU1VE25	EPC Valve 20-25psi Activation
ACCU1VE40	EPC Valve 35-40psi Activation
ACCU1VE60	EPC Valve 55-60psi Activation
ACCUC	Stainless Steel Mounting Clamps For ACCU1&2
ACCUC2	Stainless Steel Mounting Clamps For ACCU5&5E
ACCUC	Cable Operation
ACCUV2	Check Valve

For modified take off pates with non return valve & blanked port.

SPV1	Sandwich Plate 1/2BSP Port For 3/4UNF Filter
SPV1A	Sandwich Plate 1/2BSP Port For 5/8UNF Male Filter
SPV1B	Sandwich Plate 1/2BSP Port For M16 Filter
SPV1C	Sandwich Plate 1/2BSP Port For 13/16UNF Filter
SPV1D	Sandwich Plate 1/2BSP Port For M18 Filter
SPV1E	Sandwich Plate 1/2BSP Port For 5/8UNF Filter
SPV1F	Sandwich Plate 1/2BSP Port For M20 Filter
SPV1G	Sandwich Plate 1/2BSP Port For M22 Filter

## Classic Dashboard Instruments



A superb range of high quality 52mm diameter mechanical instruments with precision machined brass movements. Available with white or black face; black, 12 volt back lighting is standard. Temperature gauges have 7 foot (2 metre) capillary tubes with 3/8BSP male connections. Pressure and boost gauges have standard 1/8BSP coned male connections. Lines may be either stainless steel braided TFE, see page 40, or nylon, as below. For T pieces and adapters to facilitate gauge fitting see page 21.

Part numbers below are for black faced gauges & black bezel. Add suffix W for white faced gauge; chrome bezels can be ordered as a separate part.

Part No	
FPG15	Fuel Pressure Gauge, 0-15psi
OPG100	Oil Pressure Gauge, 0-100psi
OPG160	Oil Pressure Gauge, 0-160psi
WTG110	Water Temp Gauge, 30-110°C
OTG140	Oil Temp Gauge, 40-140°C
OPWTG	Temp / Pressure Gauge, 30-110°C / 0-100psi
OPOTG	Temp / Pressure Gauge, 40-140°C / 0-100psi
OPOTG1612	Temp / Pressure Gauge, 30-120°C / 0-160psi
TBG30	Boost Gauge, -15 - +30psi
TBG2	Boost Gauge, -1 To +2 Bar
GL5	5' Nylon Pressure Gauge Lines
GL6	6' Nylon Pressure Gauge Lines
GL7	7' Nylon Pressure Gauge Lines
GL10	10' Nylon Pressure Gauge Lines
GL15	15' Nylon Pressure Gauge Lines
CB1	Chrome Bezel

## Pressure Gauge Lines For Other Makes Of Gauge

Most other makes of gauge have 1/8BSP male fittings but with a flat seating and a pip to locate a washer. We can supply lines with these fittings at one end, part numbers as above but with suffix S, prices are the same. Also fittings for metric Ford gauges, please enquire.

## Instrument (Gauge) Isolators



Dampen vibration ensuring better vision and longer instrument life on racing cars, bikes and off road vehicles. Fit in hole 13 mm larger than gauge, useful for hiding cutting errors.

Part No	
DB206-225	Grommet For 2in / 52mm Gauge
DB260-275	Grommet For 2+5/8in / 67mm Gauge

## MOCAL Catch Tanks



Size	A	B	C
1 Litre	115mm	132mm	88mm
2 Litres	220mm	132mm	88mm
3 Litres	235mm	154mm	104mm

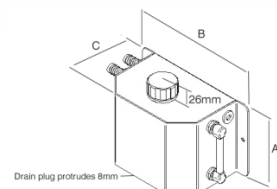

The problem of engine crankcase breathing must be considered when preparing a wet sump car for competition. To avoid oil being deposited on the track the rules state that the oil bearing vapour must be either returned to the engine or to a suitable tank where the oil may be trapped. The normal system of sending the oil to the inlet manifold is undesirable in a high performance engine.

We offer a suitable tank in 1, 2 or 3 litre sizes. Made of aluminium with a special cap incorporating a breather, there are two 1/4BSP female ports with adapters to 1/2" hose on one side and a sight tube on the other. These are interchangeable so can be handed. The tanks are polished and may be anodized red, blue or gold.

Part No	
CT3	1 Litre Brushed Aluminium
CT3C	1 Litre Chromed Aluminium
CT3RED	1 Litre Anodised Red Aluminium
CT3BLUE	1 Litre Anodised Blue Aluminium
CT3GOLD	1 Litre Anodised Gold Aluminium
CT3BLACK	1 Litre Powder Coated Black Aluminium
CT2	2 Litre Brushed Aluminium
CT2C	2 Litre Chromed Aluminium
CT2RED	2 Litre Anodised Red Aluminium
CT2BLUE	2 Litre Anodised Blue Aluminium
CT2GOLD	2 Litre Anodised Gold Aluminium
CT2BLACK	2 Litre Powder Coated Black Aluminium
CT8	3 Litre Brushed Aluminium
CT8RED	3 Litre Anodised Red Aluminium
CT8BLUE	3 Litre Anodised Blue Aluminium
CT8BLACK	3 Litre Powder Coated Black Aluminium

## MOCAL Dry Sump Tanks



A range of 3 piece easy clean tanks that can be disassembled for cleaning. They are designed to de-aerate the incoming oil and contain anti surge baffles. These are finished in natural aluminium as standard.

P/N	CAPACITY /HOLDS	BREATHER	DIAMETER CM/INCHES	HEIGHT CM/INCHES	TAPPING
DST6	4.8L/3.2L	1 x 5/8 HOSE	12.70cm/5"	38.10cm/15"	M22x1.5
DST9	7.8L/5L	1 x 5/8 HOSE	12.70cm/5"	50.80cm/20"	M22x1.5
DST4	7.6L/5L	2 x 5/8 HOSE	16.51cm/6.5"	35.56cm/14"	M22x1.5
DST2	7.6L/5L	2 x 5/8 HOSE	16.51cm/6.5"	35.56cm/14"	M22x1.5
DST11	9.8L/6L	2 x 5/8 HOSE	16.51cm/6.5"	45.72cm/18"	M22x1.5
DST7	14.4L/7L	2 x 3/4 HOSE	20.95cm/8.25"	41.91cm/16.5"	DASH 16
DST5	18.6L/9L	2 x 3/4 HOSE	24.13cm/9.5"	40.64cm/16"	DASH 16

### DST4 dimensions

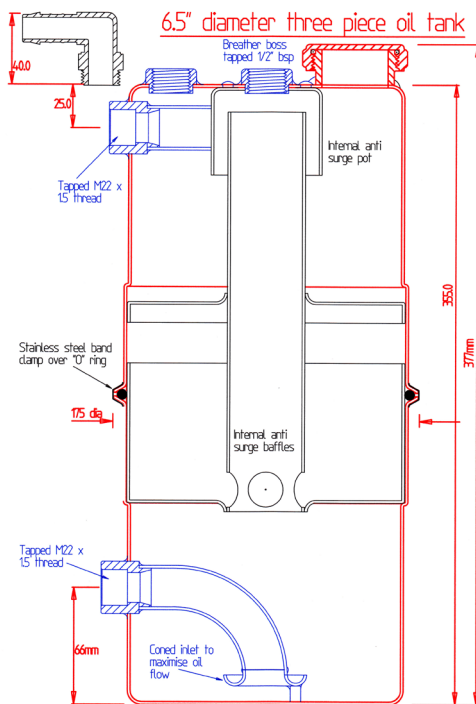

Drawings for other size tanks are available on request.

## Rain Light



High intensity rear LED rain light approved by the MSA and FIA for competition use; improved visibility in the most extreme situations.

Part No	Description
RAINLIGHT	High Intensity Rain Light

## MOCAL Fuel Swirl Pots



Mainly used with fuel injected engines, these pots act as a surge free fuel reservoir, de-aerator and if mounted in a suitable place, a cooler. Fuel from the tank is fed to the swirl pot by a low pressure pump then by high pressure pump from the pot to the injectors, unused fuel is returned to the pot then to the tank. The three upper connections are -6JIC and the lower connection (to high pressure pump) is -10JIC. Featuring internal baffle.

2 Sizes available: Height 160, dia 102 at 1.3L.  
Height 177, dia 127 at 2.1L

Part No	Description
FSP1	1.3L Fuel Swirl Pot With Mounting Base Plate
FSP2	1.3L Fuel Swirl Pot With Body Mounting Brackets
FSP3	2L Fuel Swirl pot base Mounting
FSP4	2L Fuel Swirl pot body Mounting

## Quick Release Steering



Lightweight quick release steering wheel boss, easy to connect due to ingenious mechanism for one handed operation. In our opinion this is the most user friendly mechanism available. Separate parts are available please enquire.

Part No	Description
QR-03	Quick Release Steering Boss
QR-03-22P	Quick Release Steering Boss, Including 22 Pin Connector

## Roll Control Valves



Designed for race applications, roll control valves lock brakes in line, so racers can focus on acceleration and speed instead of start up. Not recommended for use with ABS brake systems.

Part No	Description
HRC1	Hurst Roll Control Line Lock
MLL8-3	Mocal Roll Control Line Lock

## Bonnet Catches



AeroCatch are low profile bonnet pins and panel fasteners with an aerodynamic advantage, ideal for motorsport but also road legal. All are sold as pairs.

Part No	Description
120-2000	Aerocatch Plus Flush Kit
120-2100	Aerocatch Plus Flush Kit Locking
120-3000	Carbon Look Aerocatch Flush Kit
120-3100	Carbon Look Aerocatch Flush Kit Locking

## Millers Oil **NEW TO THINK AUTOMOTIVE!**

Founded in 1887 Millers Oils have always strive to to lead the way in oil innovation. Millers Oils is a highly innovative independent blender of market-leading advanced oils and fuel treatments with a history of providing creative lubricant solutions. The product portfolio includes Motorsport, Automotive, Classic vehicles, Agricultural and Commercial Vehicles. At Think Automotive we are proud to partner with these great products.



### CFS Oils

A range of fully synthetic variants, exclusively formulated to offer appreciably better performance characteristics. High performance oils that deliver up to 26% lower coefficient of friction than their predecessors. Suitable for fast road, race and rally applications.



Part No.	
MIL7953-1L	Millers Oil CFS 5W40 1LTR
MIL7953-5L	Millers Oil CFS 5W40 5LTR
MIL7956-1L	Millers Oil CFS 10W60 1LTR
MIL7956-5L	Millers Oil CFS 10W60 5LTR
MIL7957-1L	Millers Oil CFS 15W60 1LTR
MIL7957-5L	Millers Oil CFS 15W60 5LTR

### CFS NT+ Oils

Flagship range of NANODRIVE NT+ products, redefines the performance criteria associated with a motorsport oil. This ultra low friction package reduces engine friction by a further 15% over and above previous technology. Suitable for fast road, race and rally.



Part No.	
MIL7963-1L	Millers Oil CFS 5W40 NT+ 1LTR
MIL7963-5L	Millers Oil CFS 5W40 NT+ 5LTR
MIL7964GMS-5L	Millers Oil CFS NT+ 10W50 5LTRS
MIL7965-1L	Millers Oil CFS 10W60 NT+ 1LTR
MIL7965-5L	Millers Oil CFS 10W60 NT+ 5LTR

### CRX NT+ Transmission Oils

Competition grade oils formulated using a unique combination of improved chemistry and lower friction NANODRIVE additives to reduce friction vs standard oil. Suitable in manual transmissions, synchromesh, non-synchromesh, sequential gearboxes, transfer gearboxes, transaxles and hypoid differentials.



Part No.	
MIL7966-1L	Millers Oil CRX 75W90 NT+ 1LTR
MIL7967-1L	Millers Oil CRX 75W110 NT+ 1LTR
MIL7968-1L	Millers Oil CRX 75W90 NT+ 1LTR
MIL7969-1L	Millers Oil CRX 75W100 NT+ 1LTR
MIL7970-1L	Millers Oil CRX 75W140 NT+ 1LTR
MIL7990-1L	Millers Oil CRX 75W140 NT+ 1LTR

### Longlife Oils

XF Longlife is a high performance fully synthetic mid SAPS (Sulphated Ash, Phosphorous, Sulphur) engine oil suitable for the latest technology petrol and diesel engines.

EE is a fully synthetic high performance mid SAPS low friction, fuel efficient engine oil. Particularly recommended for use in VAG vehicles.



Part No.	
MIL5862-5L	Millers XF Longlife 5W30 5LTR
MIL7877-GGB	Millers EE Longlife 5W30 5LTR

### Classic Sport Oils

This product is a high performance SAE 20w50 semi synthetic multigrade engine oil. Made with enhanced performance additives and shear stable viscosity index improves in synthetic and mineral base. It is formulated with full ZDDP (zinc/phosphorus).

Classic Sport HP is the world's finest SAE 20w50 fully synthetic multigrade engine oil engineered for classic performance racing incorporating our nanodrive package. Use for lubrication of high performance engines. Ideally suited to Aston Martin, Jaguar, Ferrari, Lotus and similar high specific output engines.



Part No.	
MIL7911-GCT	Millers Classic Sport HP 20W50 5LTR
MIL7911-JCT	Millers Classic Sport HP 20W50 1LTR
MIL7912-GCT	Millers Classic Sport 20W50 5LTR
MIL7912-JCT	Millers Classic Sport 20W50 1LTR
MIL7915-GCT	Millers Classic Sport 20W60 5LTR

### Pistoneeze

This product is a moderate detergent premium multigrade mineral engine oil. Primarily designed for pre 1980 vehicles, both petrol and diesel, which were developed on the multigrade oils of their time.



Part No.	
MIL7913-GCT	Millers Pistoneeze 20W50 5LTR
MIL7913-JCT	Millers Pistoneeze 20W50 1LTR

### Mini Oil

Classic Mini oil is a moderate detergent premium multigrade mineral engine and gear oil. Designed for when the engine and gearbox share the same oil.

CTV oil is specifically formulated for competition Minis and any application where the engine and gearbox share a common oil.



Part No.	
MIL7914-GCT	Millers Classic Mini 20W50 5LTR
MIL7914-JCT	Millers Classic Mini 20W50 1LTR
MIL7959-1L	Millers Oil CTV Mini 20W50 1LTR
MIL7959-5L	Millers Oil CTV Mini 20W50 5LTR

## KR2T Oil

Bespoke CIK-FIA approved formulation for rotax and all high revving 2-stroke kart and bike engines, significant increases in power and torque are immediately noticeable.



Part No.	
MIL7960-1L	Millers Oil KR2T 1LTR
MIL7960-5L	Millers Oil KR2T 5LTR

## Brake Fluids

Racing Brake fluid 300+ has an extremely high boiling point of over 310°. It provides exceptional resistance to vapour locking and good compressibility for improved brake feel.

Performance DOT 5.1 Brake Fluid is a long life fluid for all types of hydraulic actuated brake and clutch systems, and is highly suitable for anti-lock brake (ABS) systems.



Part No.	
MIL7976-300+	Millers Race Brake Fluid 300+
MIL7977-DOT5	Millers Oil Brake Fluid Dot5.1

## Treatments

For a good as new engine; try Millers premium fuel treatments. Benefits of using a Millers Oils fuel treatment include improvement in fuel efficiency, engine response and power delivery. Cleans injectors, lubricates diesel pumps, assists in reducing emissions which then ensures optimum engine performance.



Part No.	
MIL5547-XCOOL	Millers Extra Cool 250ML
MIL5792-CVL	Millers CVL Turbo 500ML
MIL7795ME-DPF	DPF Cleaner
MIL7917-VSPE	Millers VSPE Power Plus 500ML
MIL7918MA-EPS	EPS Ethanol Protection 250ML
MIL7919MA-TANK	Tank Safe 250ML
MIL7920MA-CVLE	Classic Sport CVLe 250ML

## Diesel Injector Cleaner and Ecomax

Maximum strength, highly concentrated cleaning agent developed to remove deposits from diesel fuel injection systems. By addition to the fuel tank prior to refueling. Treats 60 litres.

High specification diesel fuel treatment for enhanced combustion efficiency and engine cleanliness, with improved detergency and lubricity enhancers. For use in all diesel vehicles including Euro IV, Euro V and Euro VI compliant engines with or without DPF. By addition to fuel in the ratio 1 part to 1000 parts (1ml/l). May also be used at double strength for additional performance.



Part No.	
MIL6204KB-DIESE	Diesel Power Ecomax (Octane+)
MIL7627ME-DIESE	Diesel Injector Cleaner 250ML

## Petrol Injector Cleaner and Ecomax

Maximum strength, highly concentrated cleaning agent developed to remove deposits from petrol fuel injection systems. By addition to the fuel tank prior to refuelling. Treats 60 litres. Specifically formulated for gasoline fuel injected engines. An octane booster and detergent package adding up to 2 octane numbers to unleaded fuel. For use in all petrol engines. By addition to fuel in the ratio 1 part to 1000 parts (1ml/l).



Part No.	
MIL6250KB-PETRO	Petrol Power Ecomax (Octane+)
MIL7628ME-PETRO	Petrol Injector Cleaner 250ML

Laminova heat exchangers are especially designed for intercoolers in turbo and supercharged petrol and diesel engines. The heat exchangers are compact, easy to install and more efficient than conventional coolers.

Laminova heat exchanger systems have a unique designed core for intercooler applications. The air-to-liquid system gives increased efficiency compared to an air-to-air system. With the air-to-liquid system you will get cold air right from the start.

High performance: The high performance, compared to that of the common plate style intercoolers, is a result of the extremely large surface area and the unique flow pattern. Laminova core design gives an extremely low pressure drop on the charged air side.

Compact design: Laminova coolers are small, compact and circular. The compact core design makes it easy to install in the inlet manifold. The heat exchanger cores are patented.

Better torque, response and performance: With intercooler cores installed, you achieve better torque, response and performance compared to those of conventional coolers. The coolers effectively increase engine efficiency and decrease fuel consumption.

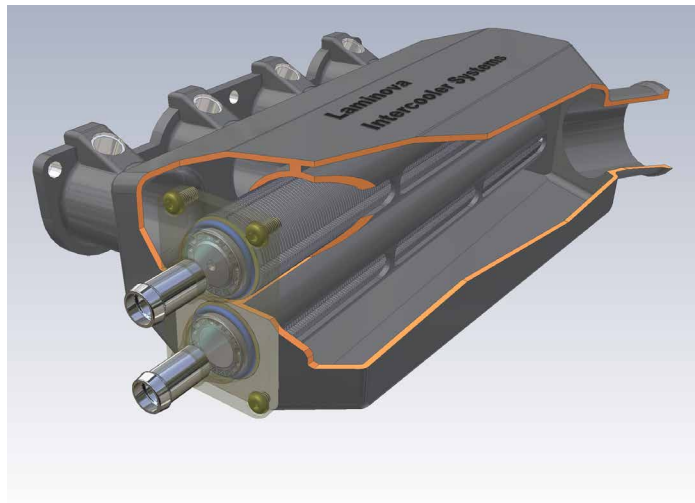

The air-to-liquid system gives increased efficiency compared to an air-to-air system.

Environmental advantages: The intercooler reduces hazardous emissions of nitrogen. The engine temperature becomes more even due to improved air distribution balance.

Installation: Best result is achieved if the heat exchanger is installed in the inlet manifold. This improves the response compared to that of traditional air-to-air intercoolers due to shorter flow length. The Laminova intercooler reduces the noise level and pulsation. The core can be delivered as a separate component, ready for installation.

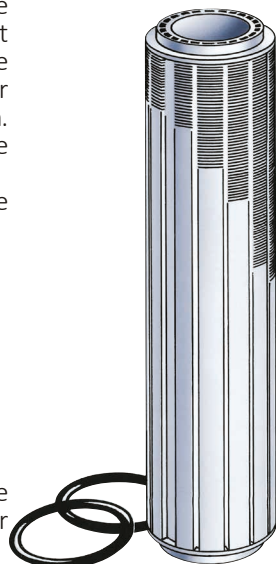

Laminova heat exchanger systems have a unique designed core for intercooler applications.

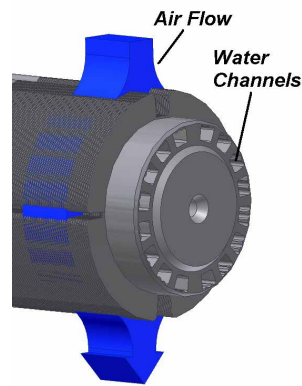

Air flow over the core.

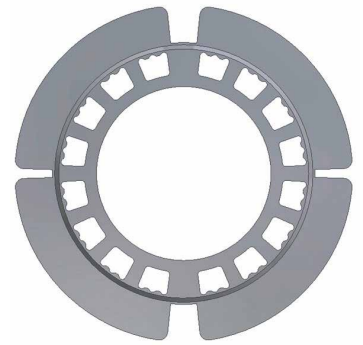

Special core for intercooler.

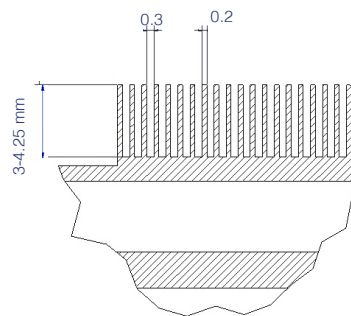

Cross section of a core showing height of fins, distances between them and their thickness in mm.

Special core for charged engines: We have a special core for air flow in charged engines. This core has longer and higher fins and fewer break-up zones (more surface) than the traditional core for liquid applications. Normally, a package of 2-4 cores is needed to meet specifications. Cores used are  $\varnothing 39.5$  and  $\varnothing 45$  mm.

Separate cooling circuit: The air-to-liquid intercooler system needs a separate cooling circuit with a circulation pump and a separate radiator. Laminova also supplies intercooler housings for use in racing/aftermarket applications and as prototypes for test and evaluation.

Usage with air conditioning systems: The Laminova intercooler can be combined with the air conditioning system for even better efficiency. Please contact Laminova for further information.





## Hose Assembly Instructions

### Aeroquip FC333 racing hose, G210 hose, GRH hose and StartLite hose

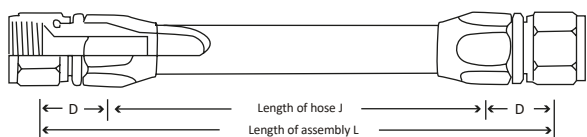

STEP 1. Determine assembly length

Type of union	Dimension 'D' in mm					
	-6	-8	-10	-12	-16	-20
Straight	30.73	34.04	37.08	39.12	43.94	49.28
45°	30.48	30.48	34.29	42.16	43.43	51.31
90°	26.67	26.42	29.97	38.86	43.18	49.53
120°	19.56	19.30	21.59	29.21		
150°	36.58	10.41	11.18	16.51		
180°	3.30	2.54	1.52	3.81		

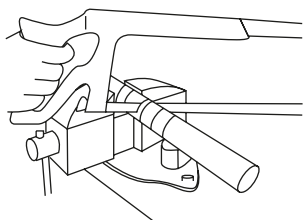

STEP 2. Cut hose squarely to length using a fine tooth hacksaw. To minimise wire braid flare out, wrap hose with masking tape before cutting.

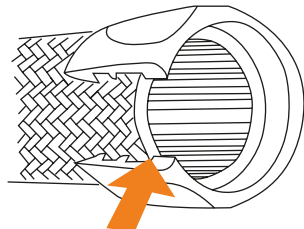

STEP 3. Remove tape. Insert hose in socket with twisting, pushing motion until hose is in line with back of socket threads.

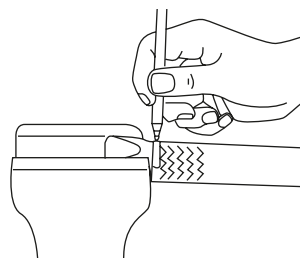

STEP 4. **IMPORTANT** - Mark position around hose at rear of socket with a grease pencil, paint or tape

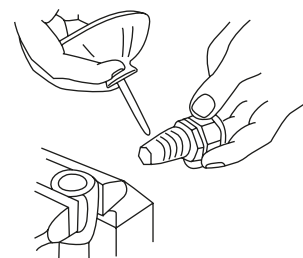

STEP 5. Lubricate inside of hose and nipple threads liberally using S.A.E. 30 lubricating oil.

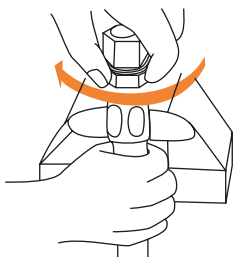

STEP 6. Carefully insert nipple and engage nipple and socket threads while holding hose in position with other hand. Make sure hose does not push out of socket by observing mark made in step 4.

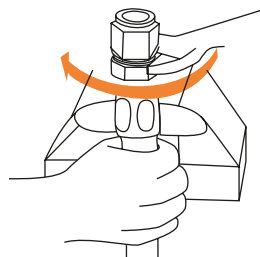

STEP 7. Complete assembly using spanner while continuing to hold hose in position. Maximum allowable gap is 0.031 inches.

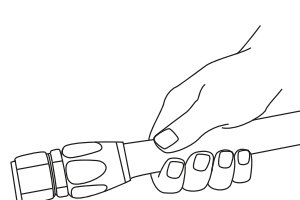

STEP 8. **IMPORTANT** - Check hose for push out by observing hose position mark. None should be evident.

Aeroquip Performance Products FBM3553 Hose Assembly Lube is a specially compounded lubricant superior to any other lubricant used in hose assembly work. Available in pint containers. Use for either hand or machine assembly.

### StartLite Racing Hose (with reuseable fittings)

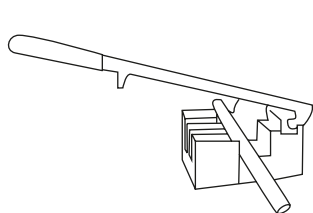

STEP 1. Cut hose square to length with Aeroquip Performance Products Cut Off Tool (FT1258) or similar cutting device.

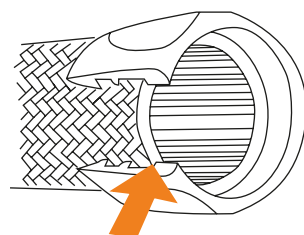

STEP 2. Insert hose in socket with twisting, pushing motion until hose is in line with back of socket threads.

Continue as steps 4-8 above.

### StartLite® Hose Routing Procedure

In most vibration applications, it may be necessary to restrain, protect, or guide the hose to protect it from damage caused by unnecessary flexing or contact with other mechanical components. Care must be taken to ensure such restraints do not introduce additional stress or wear points. StartLite® hose, when used with reuseable fittings in high vibration applications, should be supported approximately every 12 to 14 inches.

#### Notes

- Greater resistance can be expected as compared to Aeroquip Performance Products AQP® Racing Hose.
- To disassemble, reverse steps
- It is recommended that all hose assemblies be proof pressure checked at twice the operating pressure using a proof test stand such as the Aeroquip Performance Products FT1058 stand.



## Aeroquip 2807 and TFE hose

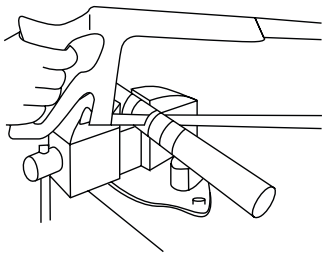

**STEP 1.** Wrap hose with masking tape at cut-off point and cut squarley through tape to length using a fine tooth hacksaw. Remove tape and trim loose wire flush with tube. Burrs on bore of tube should be removed with a knife. Clean the hose bore. One end of the hose will flare out, slide the sockets (nuts) back to back over the other end, then this end can be more easily be flared using a braid separating tool.

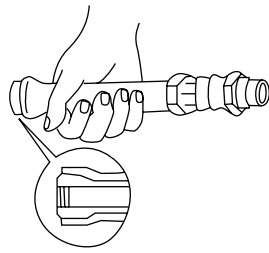

**STEP 2.** Push the sleeve over the end of the tube and under the wire braid by hand. Complete positioning of the sleeve by pushing the hose end against a flat surface. Inspect to see that the tube butts against the inside shoulder of the sleeve.

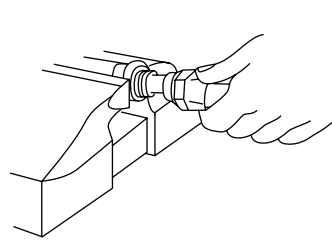

**STEP 3.** Lubricate nipple and socket threads. Use a molybdisulphide based lubricant for stainless steel fittings (e.g. Molykote Type G). Lubricants containing chloride are not recommended. Other material combinations use standard petroleum lubricants. Hold the nipple with hex in the vice. Push hose over nipple with twisting motion until seated against nipple chamfer. Push socket forward and start threading of socket to nipple.

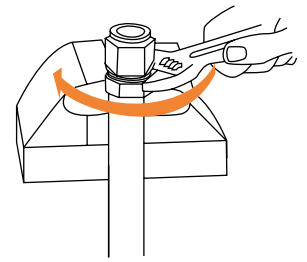

**STEP 4.** Spanner tighten hex until clearance with socket hex is 1/32" or less. Tighten further to align corners of nipple and socket hexes. To disassemble: Unscrew and remove nipple; slide socket back on hose by tapping against a flat surface, remove sleeve with pliers.

## AQP FC300 7 FC234 Hose

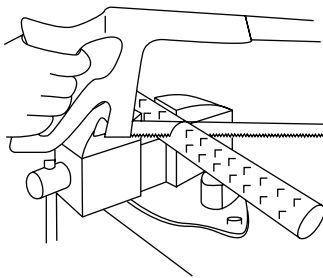

**STEP 1.** Cut hose square with a fine tooth hacksaw.

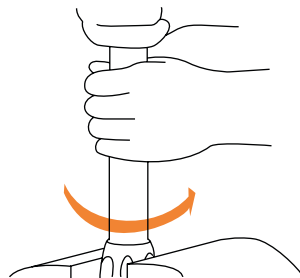

**STEP 2.** Put socket in vice, screw hose anti clockwise until it bottoms, back off 1/4 turn.

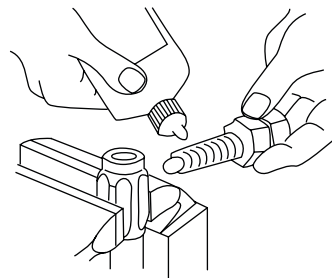

**STEP 3.** Lubricate with light oil. Brass fittings only push assembly mandrel through nipple to guide into hose without cutting.

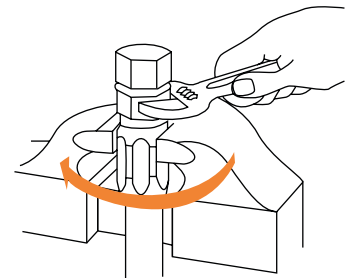

**STEP 4.** Screw nipple clockwise into hose and socket, leave 1/32" (0.8mm) clearance between nipple hex and socket.

## AQP FBN & FBV Push-lock hose Socketless Hose

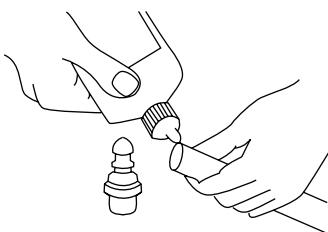

**STEP 1.** Cut hose to required length with a sharp knife. Oil inside of hose and outside of nipple liberally.

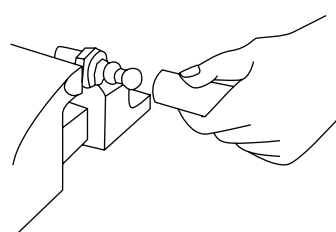

**STEP 2.** Push hose on fitting until hose end bottoms underneath protective cap as shown. Clean, proof test to twice operating pressure and inspect all assemblies. This is easier if the hose is warmed in hot, max 86°C, not boiling, water.

## Firesleeve

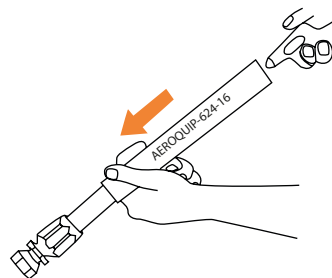

**STEP 1.** Follow the appropriate hose assembly instructions through the assembly of one end fitting. Cut firesleeve to same length as hose. Start firesleeve over cut end of hose.

Note: If applying sleeve over Teflon\* or stripped cover assemblies, wrap exposed wire with tape. Grasp Sleeve and slip over the hose assembly as illustrated.

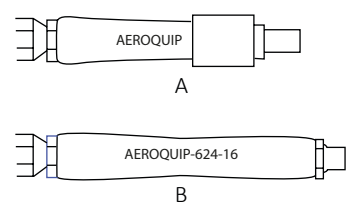

**STEP 2.** Skin sleeve back from cut end of hose enough to allow assembly of second end fitting.

Then centre sleeve so that it completely covers both sockets.

**STEP 3.** Position nylon wire tie or band clamp over sleeve on each end of the hose assembly and draw tight.

## ProGold AR hose

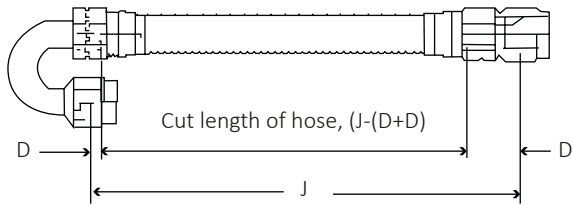

Step 1. Determine assembly length

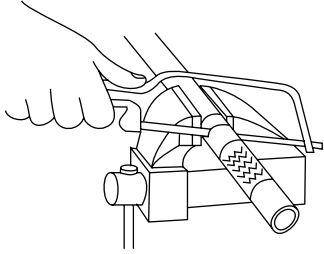

**STEP 2. Metallic braid**  
To minimise braid flare, wrap the area in masking tape. Cut the hose with a suitable fine toothed hacksaw blade. Remove the tape before the next step.

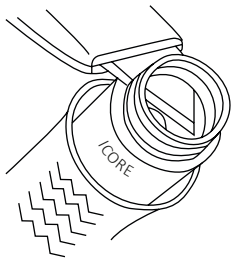

**STEP 5. Trim the hose back to be flush or a maximum of 1mm proud of the olive. Ensure the hose is cut cleanly and square.**

## Overbraid: hose finisher

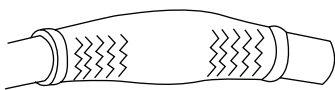

**STEP 1.** Disconnect the radiator hose, slide overbraid over the radiator hose.

## Pro-clamps: hose finisher

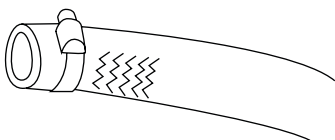

**STEP 1.** Slide clamp onto hose.

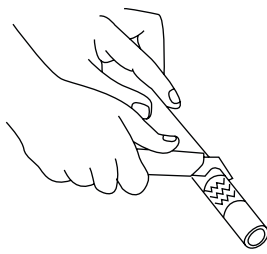

**STEP 2. Non-Metallic braid**  
Wrap PTFE (teflon) thread tape on area to be cut. DO NOT use adhesive tape of any kind. Cut the hose with a suitable sharp knife and carefully remove PTFE.

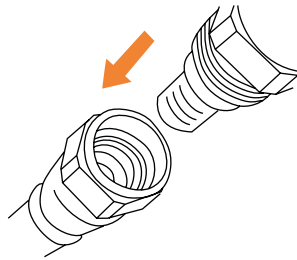

**STEP 6.** Pull the sockets up over the olives. Lubricate the fitting thread with a light oil. Insert the tail into the hose. Engage the fitting and socket threads.

## Pro-clamps: hose finisher

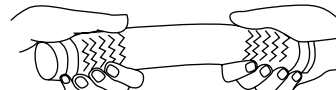

**STEP 2.** Stretch until snug, mark length and cut with tin snips.

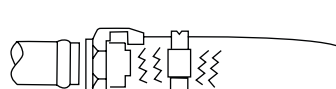

**STEP 2.** Push cap (socket) onto hose until it bottoms. Then slide clamp under cap.

Type of connection	Dimension "D" in mm				
	Size of Connection				
Straight	22.3	24.9	26.9	29.9	33.0
45°	38.1	49.0	49.2	54.8	61.4
90°	30.4	35.5	43.9	47.7	52.8
120°	32.7	40.1	48.0	60.7	64.7
150°	24.9	23.3	30.2	46.7	45.4
180°	13.7	17.2	16.7	30.4	25.9

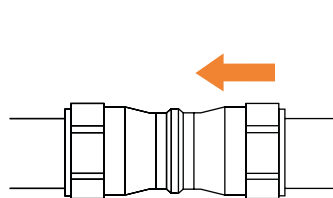

**STEP 3.** Braid tends to flare more at one end than the other. Assemble both sockets back to back from the less flared end.

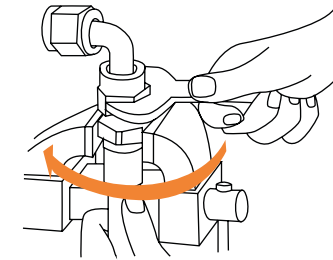

**STEP 7.** Screw together by hand, then lightly grip socket in a vice. Use a spanner to fully tighten the fitting.

## ProGold WARNING:

**NEVER** loosen fittings once assembled to achieve the desired orientation.  
**ALWAYS** use a new olive when reusing an end fitting.  
**IF IN DOUBT** consult *Think Automotive* or *BMRS*.

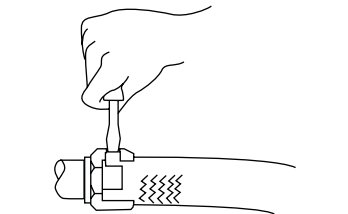

**STEP 3.** Push assembly onto beaded tube. Position clamp for appearance. Tighten with a screwdriver.

## British Standard Pipe (BSP)

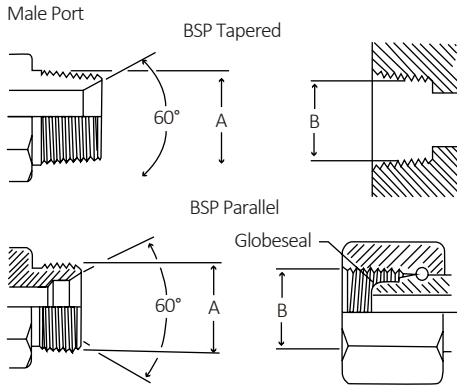

Nominal BSP Thread Size	Male Parallel Thread O.D. (A)	Female Parallel Thread I.D. (B)
1/8 - 28	3/8"	11/32"
1/4 - 19	33/64"	15/32"
3/8 - 19	21/32"	19/32"
1/2 - 14	13/16"	3/4"
5/8 - 14	29/32"	13/16"
3/4 - 14	1+1/64"	31/16"

Very common British thread; the female will often have a 60° convex seat instead of the globeseal.

## SAE 37° (formally JIC)

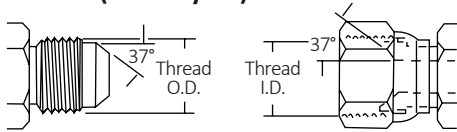

Dash Size	Thread Size	Male Thread O.D.	Female Thread I.D.
2	5/16 - 24	5/16"	9/32"
3	3/8 - 24	3/8"	11/32"
4	7/16 - 20	7/16"	5/16"
5	1/2 - 20	1/2"	7/16"
6	9/16 - 18	9/16"	1/2"
8	3/4 - 16	3/4"	11/16"
10	7/8 - 14	7/8"	13/16"
12	1 1/16 - 12	1 1/16"	31/32"
16	1 5/16 - 12	1 5/16"	17/32"

## SAE Straight Thread

### O-Ring Boss (ORB)

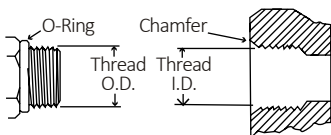

## SAE 45°

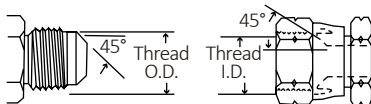

SAE 37° formally known as JIC and sometimes called AN (Air Force/ Navy) is an American thread and almost universal for performance vehicle applications. SAE straight is often called UNF, this and SAE 45°, used in air conditioning applications, share the same dimensions as SAE 37°, except -12 SAE 45° which is 14 tpi.

## Metric Female as used in oil cooler applications



Metric Thread Size	Male Thread O.D. (A)	Female Thread I.D. (B)
M18 x 1.5	18mm	16.5mm
M22 x 1.5	22mm	20.5mm

Sealing is achieved with an O-ring supplied with a fitting or adapter. When fitting or adapter is used on a **MICAL** or Setrab cooler, thread length must not exceed. The M18 female is usually used with a banjo fitting supplied with the assembly.

## DIN 7631 / 7647 Series

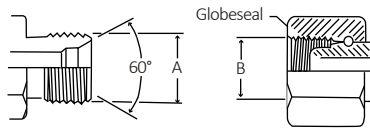

Metric Thread Size	Male Thread O.D. (A)	Female Thread I.D. (B)
M10 x 1	10mm	8.5mm
M12 x 1.5	12mm	10.5mm
M14 x 1.5	14mm	12.5mm
M16 x 1.5	16mm	14.5mm
M18 x 1.5	18mm	16.5mm
M22 x 1.5	22mm	20.5mm
M26 x 1.5	26mm	24.5mm
M30 x 1.5	30mm	28.5mm

## DIN 3901 / 3902 Series



These German series share the same thread configuration except DIN3901/2 which has an M30 x 2mm pitch. This size apart, Globeseal females are interchangeable.

## National Pipe Tapered Fuel NPTF

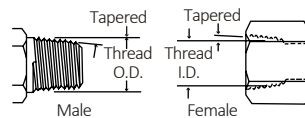

## National Pipe Straight Mechanical NPTF

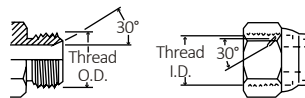

Dash Size	Thread Size	Male Thread O.D.	Female Thread I.D.
2	5/16 - 24	5/16"	9/32"
3	3/8 - 24	3/8"	11/32"
4	7/16 - 20	7/16"	5/16"
6	9/16 - 18	9/16"	1/2"
8	3/4 - 16	3/4"	11/16"
12	1 1/16 - 12	1 1/16"	13/16"
16	1 5/16 - 12	1 5/16"	17/32"

NPTF is a popular American thread often just called "pipe thread". NPSM is rarely used.

## SAE Inverted

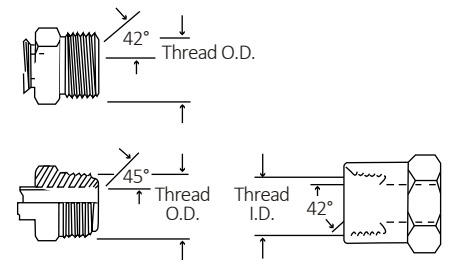

Dash Size	Thread Size	Male Thread O.D. (A)	Female Thread I.D. (B)
2	5/16 - 28	5/16"	9/32"
3	3/8 - 24	3/8"	11/32"
4	7/16 - 24	7/16"	13/32"
5	1/2 - 20	1/2"	7/16"
6	5/8 - 18	5/8"	9/16"
7	11/16 - 8	11/16"	5/8"
8	3/4 - 18	3/4"	11/16"
10	7/8 - 18	7/8"	13/16"
12	1 1/16 - 16	1 1/16"	1

The male is found as a tube nut on a flared tube, used on American power steering and pump to carburettor lines.

## JIS Tube Fitting (Metric Threads)

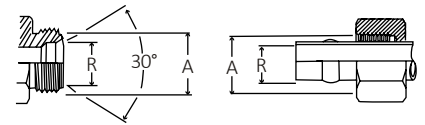

## JIS Parallel (Metric)

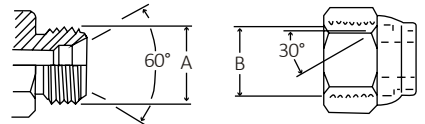

## JIS Parallel PF

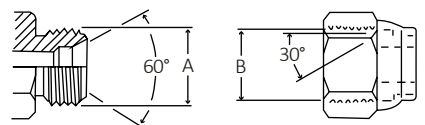

## JIS Tapered PT



## JIS 30° Flare (BSPP Threads)

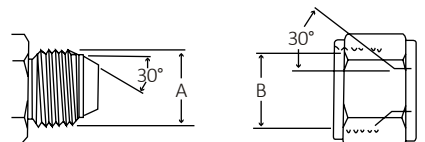

These Japanese connectors above have threads identical to BSP. The top two are interchangeable with BSP. From the left, metric parallel connectors have threads like DIN7631/7647 and tube fittings like DIN3901/2.

## Alphabetical Index

<b>A</b>		
Aero Flush Fitting Caps	79	
Aeroquip FC333 Hose	36	
Aeroquip Firesleeve	74	
Aeroquip "Push On Hose"	33	
Aeroquip Startlite Hose	36	
Air Jack System	81	
Aluminium Caps & Plugs	68	
Aluminium Fuel Blocks	64	
Aluminium Screw Cap	78	
Aluminium Tube & Fittings	55	
AQP Socketless Hose	33	
Aston & Monza Filler Caps	77	
Automatic Transmission	18	
<b>B</b>		
Banjo Adapters	63	
Billet Oilstat	18	
Blanking Caps (AN929)	67	
Blanking Plugs	66	
Bolts (AN775) For Oil & Fuel Banjos	63	
Bolts For Brake & Clutch Banjos	64	
Bonnet Catches	91	
Brake Balance Adjuster	76	
Brake & Clutch Cylinders	73	
Bulkhead Adapters	65	
<b>C</b>		
Catch Tanks	90	
Classic Dashboard Instruments	90	
Complete Remote Oil Filter Kits	23	
Conversions To Spin Off Type Filters	26	
<b>D</b>		
Dry Sump Tanks	91	
Dual Feed Assemblies For Holley Double Pumper Carburettors	39	
<b>E</b>		
Early Warning Systems	25	
EFI Adapters	68	
Electric Fuel Pumps For Fuel Injection	83	
Electric Oil Pumps	84	
Electric Water Coolant Circulation Pumps	85	
Engine Oil Cooler Installation Kits	17	
Exhaust Pipe Wrap Webbing	74	
<b>F</b>		
Filters For Electric Pumps	83	
Fittings & Adapters For MOCAL M22 Female and Setrab Proline	11	
Fittings For 100R6/R9 Hose	31	
Fittings For 100R6/R9/SPH Hose	32	
Fittings For 2807/ TFE Racing Hose, 666 & MOCAL TFE Hoses	43	
Fittings For ProGold Hose	40	
Fittings For Push On Hoses	33	
Flareless Tube Fitting	55	
Fuel/Oil Pressure Adapters	64	
Fuel Sampling Kits	73	
Fuel Tank Caps For Superbikes	80	
<b>G</b>		
G210 MOCAL Racing Hose	36	
GRH MOCAL Racing Hose	36	
Grommet Seals	75	
<b>H</b>		
Heat Resistant Sleeve & Cloth	74	
Heat Resisting Tape	74	
Heat Shrink Sleeving	74	
Hose Assembly Instructions	96	
Hose Assembly Tools	56	
Hose & Fittings, An Overview	27	
Hose Support P Clips	76	
Hose Support T Clips	75	
<b>I</b>		
Instrument (Gauge) Isolators	90	
<b>J</b>		
Jiffy-tite™ Quick Connect Fluid Fittings	69	
<b>L</b>		
Laminova ECD54 Engine Oil Coolers	16	
Laminova Oil Coolers	14	
Low Level High Flow Banjo Adapters	11	
<b>M</b>		
Metal Brake Tube & Fittings	55	
Mikalor Clamps	54	
Millers Oil	92	
<b>MOCAL</b> 100R6 Hose	30	
<b>MOCAL</b> Flat Tube & Fin Oil Coolers	10	
<b>MOCAL</b> Fuel Swirl Pots	91	
<b>MOCAL</b> Pressed Plate Coolers	8	
<b>MOCAL</b> SAE J30 R9 Fuel Injection Hose	30	
<b>MOCAL</b> Temperature Strips	26	
Mo-Clamps, Blue & Red Mo-Clamps	53	
<b>N</b>		
Nissan GTR R35 Oil Cooler	13	
<b>O</b>		
Oetiker Hose Clamps	54	
Oil Cooler Mounting Bracket	13	
Oil Cooler Take-Offs	19	
Oil Pressure Accumulators, Accusump	89	
Oilstats	18	
One Way Check Valves	72	
Original Equipment or replacement Oil Coolers	12	
<b>P</b>		
Pro-Clamps - Aeroquip	53	
ProGold Hose	40	
Proline SLM Slimline Cooler	11	
PWR 19mm Transmission & Power Steering Coolers	12	
PWR 37mm Engine, Transmission & Power Steering Coolers	12	
<b>Q</b>		
Quick Fill Refuelling Equipment	81	
Quick Release Drybreak Couplings	72	
Quick Release Steering	91	
<b>R</b>		
Radiator Caps And Necks	79	
Rain Light	91	
Red Caps & Plugs	68	
Remote Filter Heads	23	
Replacement Original Equipment Hoses	33	
Reuseable Fittings For FC333, Startlite & G210 Hose	37	
Roll Control Valves	91	
<b>S</b>		
Sandwich Plates Between Engine & Filter	25	
Seals, Washers & Gaskets	73	
Setrab Oil Coolers	10	
Silicone Rubber Coolant Hoses	51	
Smarty Flush Cap	80	
Special purpose Hoses	50	
Stainless Braided TFE Brake Hose	47	
Stainless Braided TFE Hose	43	
Stainless Steel Overbraid	53	
Swaged Fittings For FC333, Startlite	39	
Swaged Fittings For <b>MOCAL</b> TFE Hoses	48	
<b>T</b>		
Tank Breather Valves	80	
Taps	73	
Temperature Gauge Adapters	22	
T Pieces & Oil Pressure Gauge Adapters	25	
<b>W</b>		
Warning Lights	26	
Weld On Connections	67	
Wiggins Couplings	55	
Worm Drive Embossed Band Clamps	54	
Worm Drive Hose Clamps	54	
<b>X</b>		
XRP In-Line Engine Oil Filters	24	

## Part No Index

Part No	Page								
		713000	24	AC-08-G3-DS	41	AN806-20	66	AR-16-F3	40
		713000S	24	AC-08-H3	41	AN806-24D	66	AR-16-G3	40
25-932	13	713045	24	AC-08-H3-DS	42	AN816-10-4	57	AR-16-G3-DS	41
25-933	13	713045RV	24	AC-08-P3	41	AN816-16-12	57	AR-16-H3	41
25-934	13	713045S	24	AC-08-P3-DS	42	AN821-10	61	AR-16-H3-DS	42
50-107-7612	10	713045SRV	24	AC-08-R3	41	AN823-3C	61	AR-16-HTP	40
50-110-7612	10	713060	24	AC-08-R3-DS	42	AN832-20	65	AR-16-P	40
50-113-7612	10	713060RV	24	AC-08-S3-DS	42	AN834-10	65	AR-16-P3-DS	42
50-116-7612	10	713060S	24	AC-10-30JIC-3	40	AN834-12	65	AR-16-R3-DS	42
50-119-7612	10	713060SRV	24	AC-10-30JICDS-3	41	AN834-16	65	AR-16-S	40
50-125-7612	10	713075	24	AC-10-60JIC-3	41	AN917-8	62	AR-16-S3-DS	42
50-144-7612	10	713075RV	24	AC-10-60JICDS-3	41	AN918-4	63	AR-16-ST-M30	40
50-150-7612	10	713075S	24	AC-10-F3	40	AN919-6-3	57	AR-O-06	42
50-172-7612	10	713075SRV	24	AC-10-G3	40	AN919-20-16	57	AR-O-08	42
50-313-4058	10	713100	24	AC-10-G3-DS	41	AN924-20	65	AR-O-10	42
50-607-7612	10	713100RV	24	AC-10-H3	41	AR-06-45-M12	40	AR-O-12	42
50-610-7612	10	713100S	24	AC-10-H3-DS	42	AR-06-45-M14	40	AR-O-16	42
50-613-7612	10	713100SRV	24	AC-10-P3	41	AR-06-45-M16	40	AR-S-06	42
50-616-7612	10	713106AN	24	AC-10-P3-DS	42	AR-06-90-M12	41	AR-S-08	42
50-619-7612	10	713108AN	24	AC-10-R3	41	AR-06-90-M14	41	AR-S-10	42
50-625-7612	10	713110AN	24	AC-10-R3-DS	42	AR-06-90-M16	41	AR-S-12	42
50-634-7612	10	713112AN	24	AC-10-S3-DS	42	AR-06-BJ-01	42	AR-S-16	42
50-640-7612	10	713206AN	24	AC-12-30JIC-3	40	AR-06-BJ-02	42	AS7-3	56
50-644-7612	10	713206ANPD	24	AC-12-30JICDS-3	41	AR-06-BJ-03	42	AS7-4	56
50-650-7612	10	713208AN	24	AC-12-60JIC-3	41	AR-06-BJ-04	42	AS7-6	56
50-907-7612	10	713208ANPD	24	AC-12-60JICDS-3	41	AR-06-BJ-D02	42	AS7-8	56
50-910-7612	10	713210AN	24	AC-12-F3	40	AR-06-F3	40	AS7-10	56
50-913-7612	10	713210ANAP	24	AC-12-G3	40	AR-06-G3	40	AS7-12	56
50-915-7612	10	713210ANPD	24	AC-12-G3-DS	41	AR-06-G3-DS	41	AS7-16	56
50-919-7612	10	713212AN	24	AC-12-H3	41	AR-06-H3	41	AS7-4-16	56
50-925-7612	10	713212ANAP	24	AC-12-H3-DS	42	AR-06-H3-DS	42	AST25	77
50-934-7612	10	713212ANPD	24	AC-12-P3	41	AR-06-HTP	40	AST35	77
100R6-4	30	717002	24	AC-12-P3-DS	42	AR-06-P	40	AST35K	77
100R6-5	30	717003	24	AC-12-R3	41	AR-06-P3-DS	42	AST35P	77
100R6-6	30	900568-6	47	AC-12-R3-DS	42	AR-06-R3-DS	42	AST275	77
100R6-8	30	900568-8	47	AC-12-S3-DS	42	AR-06-S	40	ASTC25	77
100R6-10	30	900767-4C	47	AC-16-30JIC-3	40	AR-06-S3-DS	42	ASTC275	77
100R6-12	30	925103	62	AC-16-30JICDS-3	41	AR-06-ST-M12	40	ASTR35	77
120-2000	91	925104	62	AC-16-60JIC-3	41	AR-06-ST-M14	40	AT/2	18
120-2100	91	925106	62	AC-16-60JICDS-3	41	AR-06-ST-M16	40	AT/2C	18
120-3000	91	925108	62	AC-16-F3	40	AR-08-45-M18	40	AT/2D	18
120-3100	91	925110	62	AC-16-G3	40	AR-08-90-M18	41	AT-5	55
262	13	925112	62	AC-16-G3-DS	41	AR-08-F3	40	AT/6	18
500	22	925116	62	AC-16-H3	41	AR-08-G3	40	AT/7	18
666-4	43	926103	62	AC-16-H3-DS	42	AR-08-G3-DS	41	AT-8	55
666-6	43	926104	62	AC-16-P3	41	AR-08-H3	41	AT/8	18
704-406FS120	24	926106	62	AC-16-P3-DS	42	AR-08-H3-DS	42	AT-10	55
704-408FS120	24	926108	62	AC-16-R3	41	AR-08-HTP	40	AVJ1	56
957	31	926110	62	AC-16-R3-DS	42	AR-08-P	40	B5600-4-4	72
1206-3	47	926116	62	AC-16-S3-DS	42	AR-08-P3-DS	42	B5600-6-6	72
1206-4	47	981410TP	24	ACCU1	90	AR-08-R3-DS	42	B5600-8-10	72
2061-10-10S	61	7041406FS120	24	ACCU1A	90	AR-08-S	40	BA2-42	63
2062-10-10S	61	7041408FS120	24	ACCU1E	90	AR-08-S3-DS	42	BA2-45	63
2062-10-12S	61	7041808FS120	24	ACCU1VE25	90	AR-08-ST-M18	40	BA7-4	63
2807-3	43	A36ANL44	80	ACCU1VE40	90	AR-10-45-M22	40	BA7-M10-3	63
2807-4	43	A36ANL44K	80	ACCU1VE60	90	AR-10-90-M22	41	BA7-M10-4	63
2807-6	43	A36ANL44LF	80	ACCU2	90	AR-10-F3	40	BA7-M12-3	63
2807-8	43	A36ANL44LKF	80	ACCU2A	90	AR-10-G3	40	BA7-M12-4	63
4738-6-6	34	A68L	80	ACCU2E	90	AR-10-G3-DS	41	BA7-M12-6	63
4738-6-8	34	A68NL50	80	ACCU5	90	AR-10-H3	41	BA7-M12-6L	63
4738-8-8	34	A68NL57	80	ACCU5A	90	AR-10-H3-DS	42	BA7-M12-8	63
4742-5-4	34	A68NS50	80	ACCU5E	90	AR-10-HTP	40	BA7-M14-6	63
5601-8-10S	72	A68NS57	80	ACCUC	90	AR-10-P	40	BA7-M14-6L	63
07001-6-4	34	A68S	80	ACCUC2	90	AR-10-P3-DS	42	BA7-M14-8	63
07001-10-6	34	AC-06-30JIC-3	40	ACCUCCK	90	AR-10-R3-DS	42	BA7-M16-6	63
07001-13-8	34	AC-06-30JICDS-3	41	ACCUV2	90	AR-10-S	40	BA7-M16-8	63
07001-16-10	34	AC-06-60JIC-3	41	AE240-3	43	AR-10-S3-DS	42	BA7-M18-6	63
07006-4-4	34	AC-06-60JICDS-3	41	AGC1	74	AR-10-ST-M22	40	BA7-M18-10	63
07006-8-6	34	AC-06-F3	40	AGC2	74	AR-12-45-M26-DS	41	BA7-M20-10	63
07072-4-4	34	AC-06-G3	40	AGC3	74	AR-12-90-M26-DS	42	BA7-M22-6HF	11
07072-8-6	34	AC-06-G3-DS	41	AHA8777	33	AR-12-F3	40	BA7-M22-8	63
07072-13-8	34	AC-06-H3	41	AHA8778	33	AR-12-G3	40	BA7-M22-8HF	11
07072-16-10	34	AC-06-H3-DS	42	AHC323	33	AR-12-G3-DS	41	BA7-M22-10	63
07074-4-4	35	AC-06-P3	41	AHC323S	33	AR-12-H3	41	BA7-M22-10HF	11
07074-6-4	35	AC-06-P3-DS	42	AHC324	33	AR-12-H3-DS	42	BA7-M22-12HF	11
07074-8-6	35	AC-06-R3	41	AHC335	33	AR-12-HTP	40	BAD7-4	63
07074-10-6	35	AC-06-R3-DS	42	AHH8192	33	AR-12-P	40	BAD7-8	63
07074-13-8	35	AC-06-S3-DS	42	AHH8192S	33	AR-12-P3-DS	42	BAD7-10	63
07074-16-10	35	AC-08-30JIC-3	40	AHH8536	33	AR-12-R3-DS	42	BAD7-M10-3	63
07075-20-12	35	AC-08-30JICDS-3	41	AHH8536S	33	AR-12-S	40	BAD7-M10-4	63
07114-20-12	34	AC-08-60JIC-3	41	AHH8537	33	AR-12-S3-DS	42	BAD7-M12-4	63
704110	24	AC-08-60JICDS-3	41	AHH8537S	33	AR-12-ST-M26	40	BAD7-M12-6	63
704112	24	AC-08-F3	40	AN806-1	66	AR-16-45-M30-DS	41	BAD7-M14-4	63
704302	24	AC-08-G3	40	AN806-2	66	AR-16-90-M30-DS	42	BAD7-M14-6	63

BAR2-7	39	BHH1610S	33	BPA3-6	66	CAP3	79	DCF12	87
BAR2-7	63	BHH1612	33	BPA3-8	66	CAP3.5	78	DCF14	87
BBA1-3	64	BHH1613	33	BPA3-12	66	CAP3H	79	DCF16	87
BBA1-6	63	BHKALF-4-040	47	BPS3-3	66	CAP3S	79	DCFK08	87
BBA1-8	63	BHKALF-4-073	47	BPS3-4	66	CAP3SCAT	80	DCFK09	87
BBA1-10	63	BHKAUD-4-145	47	BPS3-6	66	CAP3SF	79	DCFK10	87
BBA2-31	64	BHKAUD-4-352	47	BPS3-8	66	CAP3SWO	79	DCFK10X	87
BBA2-32	64	BHKAUD-4-361	47	BPS3-10	66	CAP3ZF	80	DCFK12	87
BBA2-41	64	BHKBMW-4-262	47	BPS3-12	66	CAP3ZFV	80	DCFK14	87
BBA2-45	63	BHKBMW-6-619	47	BPS7-4	66	CAP5	78	DCFK16	87
BBA2-55	63	BHKBMW-4-045	47	BPS7-6	66	CAP5M	78	DCFMK	87
BBA2-65	63	BHKCIT-4-030	47	BPS7-8	66	CAP11	78	DCFS	87
BBA2-85	63	BHKFIA-6-501	47	BPS7-10	66	CAP15	78	DCFSE	87
BBA2-95	63	BHKFOR-4-217	47	BPS7-12	66	CAP20	78	DCQFK	13
BBA2-105	63	BHKFOR-4-479	47	BPS7-16	66	CAP2500	79	DCQFK	87
BBA3-4	63	BHKFOR-4-480	47	BPS7-20	66	CAP2500F	79	DST2	91
BBA3-6	63	BHKFOR-4-501	47	BPS8-3	67	CAP3500	79	DST4	91
BBA3-8	63	BHKFOR-6-478	47	BPS8-4	67	CAP3500F	79	DST5	91
BBAD1-3	64	BHKHON-4-057	47	BPS8-6	67	CAPCLIO	80	DST6	91
BBAD2-31	64	BHKHON-4-129	47	BPS8-8	67	CAPFORD1	80	DST7	91
BBAD2-32	64	BHKHON-4-737	47	BPSHS8-2	66	CAPGT40	77	DST9	91
BBAL1-3	64	BHKJAG-4-010	47	BPSHS8-3	66	CAPNOVA1	80	DST11	91
BBAL2-31	64	BHKLAM-4-004	47	BPSHS8-4	66	CAPPEU205	80	E321-3	43
BBAL2-32	64	BHKMAZ-4-096	47	BRKT1	13	CAPPEU206	80	E321-3G	43
BBS1-2	64	BHKMAZ-4-098	47	BRKT3	13	CAPVW1	80	E321-4	43
BBS1-3	64	BHKPEU-4-019	47	BRKT6	13	CAPVW1V	80	E321-6	43
BBS1-5	64	BHKPOR-4-204	47	BRKT8	13	CAR1	81	E321-8	43
BBS1A-2	64	BHKREN-4-112	47	BRKT9	13	CB1	90	E331-3	44
BBS2-21	64	BHKREN-4-113	47	BRKT13	13	CET54378/6-M38	16	E331-3G	44
BBS2-21A	63	BHKREN-4-115	47	BRKT16	13	CET543710/6-M32	16	E331-4	44
BBS2-22	64	BHKREN-4-243	47	BRKT19	13	CETC712/8-M32	16	E331-6	44
BBS2-31	64	BHKSEA-4-125	47	BRKT-350	13	CETC712/8-M38	16	E331-8	44
BBS2-31A	63	BHKSUB-4-011	47	BS1	73	CHCCK013	47	E332-3	44
BBS2-32	64	BHKSUB-4-051	47	BS1/2	73	CHCCK057	47	E332-3G	44
BBS2-35	63	BLS2-31	25	BS1/4	73	CHCCK071	47	E332-4	44
BBS2-35	64	BLS8-3	25	BS3/4	73	CHCCK095	47	E332-6	44
BBS2-41	64	BLSBBS2-31	64	BS3/8	73	CHCCK125	47	E332-8	44
BBS2-45	63	BLSBBS2-32	64	BS5/8	73	CHCCK143	47	ECB1	16
BBS2-55	63	BLSBBS1-3	64	BS5/16	73	CLA25	77	ECD54-182	16
BBS2-65	63	BMS3-3	63	BS7/8	73	CLA200	77	ECD54-250	16
BBS2-85	63	BMS7-3	63	BS7/16	73	CLA300	77	ECD54-329	16
BBS3-3	64	BMS7-4	63	BS9/16	73	CLAC25	77	ECD54SK	16
BBS14-3	64	BMSD3-3	63	BS11/32	73	CLAC275	77	EOP2	85
BBSD1-3	64	BMSD7-3	63	BS13/16	73	CLUTCH	47	EOP2-24	85
BBSD2-31	64	BMSSD7-3	63	BS15/16	73	COL2	78	EOP2-FEET	85
BBSD2-32	64	BNA3-3	65	BS21/32	73	COL25	78	EPW1	74
BBSD2-45	64	BNS1-3	65	BS-M4	73	COL275	78	EPW1B	74
BBSDL2-32	64	BNS1-4	65	BS-M5	73	COLA2	78	EPW1M	74
BBSL1-3	64	BNS1-6	65	BS-M8	73	COLA25	78	EPWT-2	74
BBSL1-4	64	BNS1-8	65	BS-M20	73	COLA275	78	EWL-AMBER	26
BBSL2-31	64	BNS2-31	65	BS-M22	73	COLAJ25	78	EWL-BLUE	26
BBSL2-32	64	BNS2-41	65	BS-M28	73	COLAR2	78	EWL/BULB	26
BBSL2-41	64	BNS3-3	65	BSSC-M12	73	CPH1	83	EWL-CLEAR	26
BBSL12-4	64	BNS3-4	65	BSSC-M14	73	CT2	90	EWL-GREEN	26
BBSLD1-3	64	BNS5/8W	45	BSSC-M18	73	CT2BLACK	90	EWL-RED	26
BBSLD2-31	64	BNS5/8W	65	BV2	76	CT2BLUE	90	EWP1	86
BBSLD3-3	64	BNSS1-3	65	BV3	76	CT2C	90	EWP004	86
BBSS1-3	64	BO044	83	BV5	76	CT2GOLD	90	EWP115	86
BBSS1-4FR	64	BO979	83	BV6	76	CT2RED	90	EWP115ALLOY	86
BBSS2-31	64	BOF5021	83	BV7	76	CT3	90	EWP115C	86
BBSS2-32	64	BOF5907	83	C43-90	14	CT3BLACK	90	EWP115CALLOY	86
BBSSL-3	64	BPA1-5	66	C43-180	14	CT3BLUE	90	EWP150A	86
BBSSLD1-3	64	BPA1-5/16	66	C43-330	14	CT3C	90	EWP150A24V	86
BCA2-45	67	BPA1-7	66	C43-9076-AO	15	CT3GOLD	90	EWP150AC	86
BCA2-45B	67	BPA2-11	66	C43-9076-M18	14	CT3RED	90	EWP11524V	86
BCA2-45B	83	BPA2-21	66	C43-9078-M28	14	CT8	90	EWP11524VALLOY	86
BCA2-55	67	BPA2-31	66	C43-18078-M32	14	CT8BLACK	90	EWPC3	85
BCA2-65	67	BPA2-41	66	C43-90710-M32	14	CT8BLUE	90	EWPC0500	86
BCA2-85	67	BPA2-41SH	66	C43-90716-M45	14	CT8RED	90	EWS/1C	25
BCA2-105	67	BPA2-45	66	C43-180710-M38	14	CVD7-4	72	EWS/1D	25
BCA2-125	67	BPA2-45SH	66	C43-180712-M45	14	CVD7-6	72	EWS/1G	85
BCA2-165	67	BPA2-55	66	C43-180716-M45	14	CVD7-8	72	EWS/2B	25
BCA7-2	67	BPA2-55SH	66	C43-330710-M32	14	CVD14-5	72	F506-4C	47
BCS3-3	67	BPA2-65	66	C43-330710-M38	14	CVF2-105	72	F6605-4	44
BCS3-4	67	BPA2-65SH	66	C43-330712-M38	14	CVF7-6B	72	F6633-4	44
BCS3-6	67	BPA2-85	66	C43-330716-M45	14	CVF7-8B	72	FAN96B	87
BCS3-8	67	BPA2-95	66	C43B1	15	CVF7-10	72	FAN96S	87
BCS3-10	67	BPA2-95SH	66	CAP2	79	CVF7-12	72	FAN115B	13
BCS3-12	67	BPA2-105	66	CAP2H	79	CVF7-16	72	FAN115B	87
BCS7-20	67	BPA2-105SH	66	CAP2S	79	DB206-225	90	FAN115S	13
BCS7-24	67	BPA2-115	66	CAP2SF	79	DB260-275	90	FAN115S	87
BHH1103	33	BPA2-125	66	CAP2SWO	79	DCF08	87	FAN167S	87
BHH1104	33	BPA2-165	66	CAP2T	79	DCF09	87	FAN11912	13
BHH1341	33	BPA3-3	66	CAP2TF	79	DCF10	87	FBA0400	36
BHH1610	33	BPA3-4	66	CAP2TWO	79	DCF10X	87	FBA0600	36

FBA0800	36	FBM1112	44	FBM2025	61	FBM2143	60	FBM2793	65
FBA1000	36	FBM1113	44	FBM2026	61	FBM2144	60	FBM2799	65
FBA1200	36	FBM1114	44	FBM2030	61	FBM2147	61	FBM2808	65
FBA1600	36	FBM1120	44	FBM2031	61	FBM2148	61	FBM2809	65
FBA2000	36	FBM1121	44	FBM2032	61	FBM2149	61	FBM2815	65
FBA2400	36	FBM1122	44	FBM2033	61	FBM2150	62	FBM2893	65
FBA3200	36	FBM1123	44	FBM2034	61	FBM2151	62	FBM2914	62
FBE1012	37	FBM1130	43	FBM2035	61	FBM2152	62	FBM2915	62
FBE1013	37	FBM1134	43	FBM2036	61	FBM2156	57	FBM2916	62
FBE1014	37	FBM1135	43	FBM2037	61	FBM2160	57	FBM2917	62
FBE1015	37	FBM1136	44	FBM2038	61	FBM2162	57	FBM2918	62
FBE1512	34	FBM1137	47	FBM2039	61	FBM2163	57	FBM2938	63
FBE1513	34	FBM1138	47	FBM2040	61	FBM2165	57	FBM2942	58
FBE1514	34	FBM1140	44	FBM2041	61	FBM2166	57	FBM2953	58
FBE1515	34	FBM1141	47	FBM2048	57	FBM2167	57	FBM2954	58
FBE1522	34	FBM1143	47	FBM2049	57	FBM2169	57	FBM2955	58
FBE1523	34	FBM1144	47	FBM2050	57	FBM2170	57	FBM2963	58
FBE1524	34	FBM1146	44	FBM2051	57	FBM2173	62	FBM2965	58
FBE1525	34	FBM1147	37	FBM2052	57	FBM2174	62	FBM2971	62
FBE1532	35	FBM1148	37	FBM2053	57	FBM2175	62	FBM2972	62
FBE1533	35	FBM1150	44	FBM2054	57	FBM2176	62	FBM2973	62
FBE1534	35	FBM1151	44	FBM2055	57	FBM2177	62	FBM2974	62
FBE1535	35	FBM1153	72	FBM2056	57	FBM2178	64	FBM2978	62
FBE4022	37	FBM1155	47	FBM2060	61	FBM2179	64	FBM2979	62
FBE4023	37	FBM1200	34	FBM2061	61	FBM2180	65	FBM2981	62
FBE4024	37	FBM1201	34	FBM2062	61	FBM2183	64	FBM2982	62
FBE4025	37	FBM1202	34	FBM2063	61	FBM2183	85	FBM3011	72
FBE4032	37	FBM1207	34	FBM2064	61	FBM2184	64	FBM3012	72
FBE4033	37	FBM1211	34	FBM2065	61	FBM2184	85	FBM3013	72
FBE4034	37	FBM1222	34	FBM2066	61	FBM2185	57	FBM3079	72
FBE4035	37	FBM1225	34	FBM2071	65	FBM2186	61	FBM3081	72
FBL1512	34	FBM1233	34	FBM2072	65	FBM2187	62	FBM3082	72
FBL1513	34	FBM1234	34	FBM2073	65	FBM2188	57	FBM3083	72
FBL1514	34	FBM1343	38	FBM2074	65	FBM2189	57	FBM3084	72
FBL1515	34	FBM1344	38	FBM2075	65	FBM2190	61	FBM3085	72
FBL1522	34	FBM1345	38	FBM2076	65	FBM2191	61	FBM3086	72
FBL1523	34	FBM1438	34	FBM2081	65	FBM2272	64	FBM3087	72
FBL1524	34	FBM1439	34	FBM2082	65	FBM2273	64	FBM3113	72
FBL1525	34	FBM1440	34	FBM2083	65	FBM2274	64	FBM3114	72
FBL1532	35	FBM1441	35	FBM2084	65	FBM2403	67	FBM3148	60
FBL1533	35	FBM1442	35	FBM2085	65	FBM2404	67	FBM3149	60
FBL1534	35	FBM1443	35	FBM2086	65	FBM2405	67	FBM3150	60
FBL1535	35	FBM1512	34	FBM2091	65	FBM2406	67	FBM3151	60
FBL1542	35	FBM1513	34	FBM2092	65	FBM2407	67	FBM3155	60
FBL1543	35	FBM1514	34	FBM2093	65	FBM2511	57	FBM3156	60
FBL1544	35	FBM1515	34	FBM2099	65	FBM2512	57	FBM3157	60
FBL1545	35	FBM1522	34	FBM2100	65	FBM2515	57	FBM3158	60
FBL1552	35	FBM1523	34	FBM2103	65	FBM2517	57	FBM3479	67
FBL1553	35	FBM1524	34	FBM2104	65	FBM2518	57	FBM3480	67
FBL1554	35	FBM1525	34	FBM2105	65	FBM2519	57	FBM3481	76
FBL1555	35	FBM1532	35	FBM2106	65	FBM2521	57	FBM3482	76
FBL1562	35	FBM1533	35	FBM2107	58	FBM2522	57	FBM3483	76
FBL1563	35	FBM1534	35	FBM2108	58	FBM2524	57	FBM3484	76
FBL1564	35	FBM1535	35	FBM2110	58	FBM2526	57	FBM3485	76
FBL1565	35	FBM1542	35	FBM2111	58	FBM2527	57	FBM3486	76
FBM1001	53	FBM1543	35	FBM2112	58	FBM2528	57	FBM3487	76
FBM1002	53	FBM1544	35	FBM2113	58	FBM2531	57	FBM3488	76
FBM1003	53	FBM1545	35	FBM2114	58	FBM2532	57	FBM3513	73
FBM1004	53	FBM1552	35	FBM2116	58	FBM2586	61	FBM3514	73
FBM1005	53	FBM1553	35	FBM2117	65	FBM2589	61	FBM3515	73
FBM1011	37	FBM1554	35	FBM2118	65	FBM2593	61	FBM3516	73
FBM1012	37	FBM1555	35	FBM2119	61	FBM2594	61	FBM3517	73
FBM1013	37	FBM1562	35	FBM2120	61	FBM2595	61	FBM3534	76
FBM1014	37	FBM1563	35	FBM2121	62	FBM2608	58	FBM3535	76
FBM1015	37	FBM1564	35	FBM2122	62	FBM2609	58	FBM3536	76
FBM1016	37	FBM1565	35	FBM2123	62	FBM2610	61	FBM3537	76
FBM1017	37	FBM2000	57	FBM2124	62	FBM2611	61	FBM3538	76
FBM1021	37	FBM2001	57	FBM2125	62	FBM2616	61	FBM3554	55
FBM1027	37	FBM2002	57	FBM2126	62	FBM2617	61	FBM3555	55
FBM1031	37	FBM2003	57	FBM2127	65	FBM2620	61	FBM3556	65
FBM1037	37	FBM2004	57	FBM2128	65	FBM2626	61	FBM3566	67
FBM1066	39	FBM2005	57	FBM2129	62	FBM2627	61	FBM3602	67
FBM1067	39	FBM2006	57	FBM2130	62	FBM2628	61	FBM3603	67
FBM1068	39	FBM2007	57	FBM2131	62	FBM2631	61	FBM3604	67
FBM1069	39	FBM2008	57	FBM2132	57	FBM2714	62	FBM3605	67
FBM1070	39	FBM2009	57	FBM2133	57	FBM2719	60	FBM3632	56
FBM1073	72	FBM2010	57	FBM2134	57	FBM2750	57	FBM3642	73
FBM1074	72	FBM2011	57	FBM2135	57	FBM2751	57	FBM3646	56
FBM1100	43	FBM2012	57	FBM2136	60	FBM2754	57	FBM3647	68
FBM1101	43	FBM2013	57	FBM2137	60	FBM2756	57	FBM3648	68
FBM1102	43	FBM2020	61	FBM2138	60	FBM2769	65	FBM3649	68
FBM1103	43	FBM2021	61	FBM2139	60	FBM2772	65	FBM3650	68
FBM1104	43	FBM2022	61	FBM2140	60	FBM2774	65	FBM3651	68
FBM1110	44	FBM2023	61	FBM2141	60	FBM2775	65	FBM3652	68
FBM1111	44	FBM2024	61	FBM2142	60	FBM2790	65	FBM3653	68

FBM3654	68	FBM4137	39	FBM5017	61	FCP0134	39	GS101-2H-16S	75
FBM3655	68	FBM4212	39	FBM5020	61	FD54HE-3	72	GS101-2H-BL	75
FBM3656	68	FBM4213	39	FBM5021	61	FD543-3	72	GS101-NHBL	75
FBM3657	68	FBM4214	39	FBM5022	61	FD543-3F	72	GS404-16	75
FBM3658	68	FBM4215	39	FBM5023	61	FD547-3	72	GS404-30	75
FBM3659	68	FBM4216	39	FBM5024	61	FERSS-03	48	GS404-BL	75
FBM3660	68	FBM4217	39	FBM5025	61	FF8-3-5	82	GS1003-2H-4	75
FBM3669	55	FBM4222	39	FBM5030	61	FF74	82	GS1003-2H-6	75
FBM3670	55	FBM4223	39	FBM5031	61	FF400	82	GS1003-2H-8	75
FBM3671	55	FBM4224	39	FBM5032	61	FFA97-10	62	GS1003-2H-10	75
FBM3672	55	FBM4225	39	FBM5033	61	FFS3-3	62	GS1003-2H-12	75
FBM3673	55	FBM4226	39	FBM5034	61	FFS3-3-4	62	GS1003-2H-16	75
FBM3674	55	FBM4232	39	FBM5035	61	FFS3-4	62	GS1003-2H-BL	75
FBM3675	55	FBM4233	39	FBM5036	61	FFS3-4-6	62	GS1003-3H-4	75
FBM3676	55	FBM4234	39	FBM5037	61	FFS3-6	62	GS1003-3H-6	75
FBM3677	55	FBM4235	39	FBM5038	61	FFS3-8	62	GS1003-3H-8	75
FBM3678	55	FBM4236	39	FBM5039	61	FFS3-10	62	GS1003-3H-10	75
FBM3684	66	FBM4242	39	FBM5048	57	FFS7-4	62	GS1003-3H-12	75
FBM3685	66	FBM4243	39	FBM5049	57	FFS7-6	62	GS1003-3H-16	75
FBM3686	66	FBM4244	39	FBM5050	57	FG-08	74	GS1003-3H-BL	75
FBM3687	66	FBM4245	39	FBM5051	57	FG-12	74	GS1003-4	75
FBM3701	66	FBM4246	39	FBM5052	57	FG-15	74	GS1003-6	75
FBM3712	66	FBM4252	39	FBM5053	57	FG-22	74	GS1003-6INBL	75
FBM3713	66	FBM4253	39	FBM5054	57	FH3	22	GS1003-8	75
FBM3714	66	FBM4254	39	FBM5055	57	FK1	83	GS1003-10	75
FBM3715	66	FBM4255	39	FBM5056	57	FK2	83	GS1003-12	75
FBM3716	66	FBM4256	39	FBM5156	57	FK5	83	GS1003-16	75
FBM3717	66	FBM4263	39	FBM5160	57	FKS1	83	GS1003-20	75
FBM3718	66	FBM4264	39	FBM5162	57	FLAA2	78	GS1003-BL	75
FBM3720	47	FBM4265	39	FBM5163	57	FLAA25	78	GS2003-5	75
FBM3721	47	FBM4412	37	FBM5166	57	FLAA35	78	GS2003-5WPT	75
FBM3722	66	FBM4413	37	FBM5167	57	FLAA275	78	GS4001-WPT	75
FBM3723	66	FBM4414	37	FBM5170	57	FLAC2	78	GS5001-1	75
FBM3724	66	FBM4415	37	FBM5185	57	FLAC25	78	GS5001-2	75
FBM3725	66	FBM4416	37	FBS0500	74	FLAC275	78	GS50238	75
FBM3726	66	FBM4422	37	FBS0700	74	FLAF25	78	GS50238-BL	75
FBM3727	66	FBM4423	37	FBS0800	74	FLAF35	78	GS-SB1	75
FBM3740	67	FBM4424	37	FBS0900	74	FLAF275	78	H650-03C-CCV	48
FBM3741	67	FBM4425	37	FBS1000	74	FLAP2	78	H650-03C-CVX	48
FBM3742	67	FBM4426	37	FBS1100	74	FMK1	82	H650-04	48
FBM3743	67	FBM4432	37	FBS1200	74	PG15	90	H650-18C-CVX	48
FBM3744	67	FBM4433	37	FBS1300	74	FPH3	83	H650-31C-CCV	48
FBM3749	66	FBM4434	37	FBS1400	74	FPH4	83	H650-31C-CVX	48
FBM3750	66	FBM4435	37	FBS1600	74	FR-5	83	H650-32C-CCV	48
FBM3751	67	FBM4436	37	FBS1800	74	FRT1	82	H650-32C-CVX	48
FBM3752	67	FBM4442	38	FBS2000	74	FS82	85	H652-03C-CCV	48
FBM3820	47	FBM4443	38	FBS2200	74	FS88	85	H652-03C-CVX	48
FBM3821	47	FBM4444	38	FBS2400	74	FSK1	73	H652-18C-CCV	48
FBM3822	47	FBM4445	38	FBT1	82	FSK1PO	73	H652-18C-CVX	48
FBM4022	37	FBM4446	38	FBU0400	36	FSK2	73	H652-31C-CCV	48
FBM4023	37	FBM4452	38	FBU0600	36	FSK2PO	73	H652-31C-CVX	48
FBM4024	37	FBM4453	38	FBU0800	36	FSK3	73	H652-32C-CCV	48
FBM4025	37	FBM4454	38	FBU1000	36	FSK3PO	73	H652-32C-CVX	48
FBM4026	37	FBM4455	38	FBU1200	36	FSP1	91	H653-03C-CCV	48
FBM4032	37	FBM4456	38	FBU1600	36	FSP2	91	H653-03C-CVX	48
FBM4033	37	FBM4462	38	FBV0400	33	FSP3	91	H653-04C-CCV	48
FBM4034	37	FBM4463	38	FBV0600	33	FSP4	91	H653-31C-CCV	48
FBM4035	37	FBM4464	38	FBV0800	33	FSS1	82	H653-31C-CVX	48
FBM4036	37	FBM4465	38	FBV1000	33	FT1	82	H653-32C-CCV	48
FBM4042	38	FBM4466	38	FBV1200	33	FT1-3	62	H653-32C-CVX	48
FBM4043	38	FBM4472	37	FC283	26	FT2-31	62	H654-03C-CCV	48
FBM4044	38	FBM4473	37	FC285	26	FUN1	79	H654-03C-CVX	48
FBM4045	38	FBM4474	37	FC286	26	FUN2	79	H654-04C-CCV	48
FBM4046	38	FBM4475	37	FC287	26	G210-4	36	H654-31C-CCV	48
FBM4052	38	FBM4476	37	FC288	26	G210-6	36	H654-31C-CVX	48
FBM4053	38	FBM4482	37	FC289	26	G210-8	36	H654-32C-CCV	48
FBM4054	38	FBM4483	37	FC290	26	G210-10	36	H654-32C-CVX	48
FBM4055	38	FBM4484	37	FC291	26	G210-12	36	H657-03C	48
FBM4056	38	FBM4485	37	FC292	26	GL5	90	H657-31C	48
FBM4062	38	FBM4486	37	FC295	26	GL6	90	H657-32C	48
FBM4063	38	FBM5000	57	FC1369	26	GL7	90	H658-03C	48
FBM4064	38	FBM5001	57	FC1766	26	GL10	90	H658-31C	48
FBM4065	38	FBM5002	57	FC1767	26	GL15	90	H658-32C	48
FBM4066	38	FBM5003	57	FC3191	26	GRH-4	36	H659-03C	49
FBM4072	37	FBM5004	57	FC8741	26	GRH-6	36	H659-03CL	49
FBM4073	37	FBM5005	57	FCB1-3	63	GRH-8	36	H660-31C	49
FBM4074	37	FBM5006	57	FCB2-31	63	GRH-10	36	H663-03C	49
FBM4075	37	FBM5007	57	FCDB2	26	GRH-12	36	H663-31C	49
FBM4076	37	FBM5008	57	FCM3410	56	GRH-16	36	H663-32C	49
FBM4082	37	FBM5009	57	FCM3644	56	GS101-2H-4	75	H664-03C	49
FBM4083	37	FBM5010	57	FCM3661	56	GS101-2H-6	75	H664-31C	49
FBM4084	37	FBM5011	57	FCMGC	26	GS101-2H-8	75	H664-32C	49
FBM4085	37	FBM5013	57	FCP0101	39	GS101-2H-10	75	H665-03C	49
FBM4086	37	FBM5015	57	FCP0102	39	GS101-2H-12	75	H665-31C	49
FBM4127	39	FBM5016	61	FCP0129	39	GS101-2H-16	75	H665-32C	49



H666-03C	49	HC5-15	54	HEF42-125	32	HEFAP3-8	34	HEFP97-12	35
H666-31C	49	HC5-16	54	HEF42-165	31	HEFAP3-10	34	HEM1-5-5	32
H666-32C	49	HC5-17	54	HEF42-165	32	HEFAP7-4	34	HEM1-11-8	31
H669-31C	49	HC5-18	54	HEF42-165-16	32	HEFAP7-6	34	HEM2-31-5	32
H669-31CL	49	HCF-1	49	HEF43-6	32	HEFAP7-8	34	HEM2-41-5	32
H669-32C	49	HCF-2	49	HEF43-8	31	HEFAP7-10	34	HEM2-45-4	32
H673-03C-CCV	48	HCP-1	54	HEF43-10	31	HEFAP7-12	34	HEM2-55-5	32
H673-18C-CCV	48	HEAB7-10-M13	66	HEF43-12	31	HEFAP27-6	35	HEM2-55-8	31
H673-31C-CCV	48	HEAB14-M13	66	HEF47-6	32	HEFAP27-6BK	35	HEM2-55-8	32
H673-32C-CCV	48	HEAB14-M13-M16	66	HEF47-8	31	HEFAP27-8	35	HEM2-55-10	31
H674-03C-CCV	49	HEAB14-M13-M16W	66	HEF47-10	31	HEFAP27-8BK	35	HEM2-55-10	32
H674-18C-CCV	49	HEAB14-M13W	66	HEF47-10-8	31	HEFAP27-10	35	HEM2-65-6	32
H674-31C-CCV	49	HEADV-M51	88	HEF47-12	31	HEFAP27-10BK	35	HEM2-65-8	31
H674-32C-CCV	49	HEADV-M63	88	HEF82-85	31	HEFAP27-12	35	HEM2-65-8	32
H683-03C-CVX	48	HEAJ-M51-M63	88	HEF82-85	32	HEFAP27-12BK	35	HEM2-65-10	31
H683-18C-CVX	48	HEALH1	88	HEF83-8	31	HEFAP43-8	34	HEM2-65-10	32
H683-31C-CVX	48	HEAMH1	88	HEF83-10	31	HEFAP43-10	34	HEM2-85-8	31
H683-32C-CVX	48	HEAV-M51	88	HEF92-31-4mm	32	HEFAP47-6	34	HEM2-85-8	32
H684-03C-CVX	49	HEAV-M63	88	HEF92-55-5	32	HEFAP47-6BK	34	HEM2-85-10	32
H684-18C-CVX	49	HEAY-M63	88	HEF92-55-5F	32	HEFAP47-8	34	HEM3-4-5	32
H684-31C-CVX	49	HEBAN2-41-5	32	HEF92-65-4	32	HEFAP47-8BK	34	HEM3-4-8	31
H684-32C-CVX	49	HEBAN-3-4	32	HEF92-65-4F	32	HEFAP47-10	34	HEM3-6-5	32
H692-03-08C	49	HEBAN3-41-5-5	32	HEF92-65-6	32	HEFAP47-10BK	34	HEM3-6-8	31
H692-03-11C	49	HEBAN9-M12-5	32	HEF92-85	31	HEFAP47-12	34	HEM3-8	31
H692-03-12C	49	HEBAN9-M14-6	32	HEF92-85	32	HEFAP47-12BK	34	HEM3-8-10	31
H692-03C	49	HEBANA1-M14-6	39	HEF92-85-24C	32	HEFAP57-6	35	HEM6-6-10	31
H692-04C	49	HEBANA1-M16-6	39	HEF92-105-10	32	HEFAP57-6BK	35	HEM7-10-8	31
H693-03C	49	HEBANA2-65-8	39	HEF92-115-10	32	HEFAP57-8	35	HEM7-12	31
H694-03C	49	HEBANA-M12-6	39	HEF92-125	31	HEFAP57-8BK	35	HEM8-3-3	32
H695-03C	49	HEBANA-M14-6	39	HEF92-125	32	HEFAP57-10	35	HEM8-3-5	32
H697-03C	49	HEBANA-M14-8	39	HEF92-165	31	HEFAP57-10BK	35	HEM8-4-4	32
H698-03C	49	HEBANA-M16-6	39	HEF92-165	32	HEFAP57-12	35	HEM8-4-5	32
H699-03C	49	HEBANA-M18-6	39	HEF92-165-16	32	HEFAP57-12BK	35	HEM8-4-6	32
H801	82	HEBANA-M18-8	39	HEF93-6	32	HEFAP87-6	35	HEM8-4-8	31
H802	82	HEBANA-M22-6	39	HEF93-6-5	32	HEFAP87-6BK	35	HEM8-6-8	31
H803	82	HEBAN-M8-3	32	HEF93-8	31	HEFAP87-8	35	HEM8-6-8B	31
H803BP	82	HEBAN-M8-4	32	HEF93-8-5	32	HEFAP87-8BK	35	HEM98-3-2	32
H804	82	HEBAN-M10-4	32	HEF93-10	31	HEFAP87-10	35	HEM98-3-4	32
H812	82	HEBAN-M10-5	32	HEF93-10-8	31	HEFAP87-10BK	35	HEM98-3-5	32
H8151	82	HEBAN-M12-4	32	HEF93-12	31	HEFAP87-12	35	HEM98-4-5	32
HAR3	46	HEBAN-M12-5	32	HEF93L-8	31	HEFAP87-12BK	35	HEM98-4-6	32
HAR5	64	HEBAN-M12-6	32	HEF97-6	31	HEFAP93-8	35	HEMA2-85-8	31
HC1-1	54	HEBAN-M14-4	32	HEF97-6	32	HEFAP93-10	35	HEMA2-105-6	11
HC1-2	54	HEBAN-M14-5	32	HEF97-6-4	32	HEFAP97-4	35	HEMA2-105-6	38
HC1-3	54	HEBAN-M14-6	32	HEF97-6-5	32	HEFAP97-4BK	35	HEMA2-105-8	11
HC2-1	54	HEBAN-M16-6	32	HEF97-8	31	HEFAP97-6	35	HEMA2-105-8	38
HC2-2	54	HEBAN-M16-8	32	HEF97-10	31	HEFAP97-6BK	35	HEMA2-105-10	11
HC2-3	54	HEBAN-M18-6	32	HEF97-10-8	31	HEFAP97-8	35	HEMA2-105-10	38
HC2-4	54	HEBAN-M18-8	32	HEF97-12	31	HEFAP97-8BK	35	HEMA2-105-12	11
HC2-5	54	HEBAN-M18-10	32	HEFA2-45-6	37	HEFAP97-10	35	HEMA2-105-12	38
HC2-6	54	HEBAN-M22-12	32	HEFA2-55-6	37	HEFAP97-10BK	35	HEMA42-105-6	11
HC2-7	54	HEF2-55-4C	32	HEFA2-65-6	37	HEFAP97-12	35	HEMA42-105-6	38
HC2-8	54	HEF2-55-5	32	HEFA2-85-8	37	HEFAP97-12BK	35	HEMA42-105-8	11
HC2-9	54	HEF2-55-5C	32	HEFA2-115-10	37	HEFP3-4	34	HEMA42-105-8	38
HC3-1	54	HEF2-55-5C	32	HEFA2-125-12	37	HEFP3-4-6	34	HEMA42-105-10	11
HC3-2	54	HEF2-55-5L	32	HEFA4C7-6DS	38	HEFP3-6	34	HEMA42-105-10	38
HC3-2.5	54	HEF2-65-5	32	HEFA4C7-8DS	38	HEFP3-8	34	HEMA42-105-12	11
HC3-3	54	HEF2-65-5C	32	HEFA4C7-10DS	38	HEFP3-10	34	HEMA42-105-12	38
HC3-4	54	HEF2-65-6	32	HEFA4C7-12DS	38	HEFP3-12	34	HEMA92-105-6	11
HC3-5	54	HEF2-65-6C	32	HEFA4F2-45-6	39	HEFP7-4	34	HEMA92-105-6	38
HC3-7	54	HEF2-85	31	HEFA4F2-55-6	39	HEFP7-6	34	HEMA92-105-8	11
HC4-00	54	HEF2-85	32	HEFA4F2-65-6	39	HEFP7-8	34	HEMA92-105-8	38
HC4-0	54	HEF2-125	31	HEFA4F2-85-8	39	HEFP7-8-6	34	HEMA92-105-10	11
HC4-1	54	HEF2-125	32	HEFA4F2-115-10	39	HEFP7-10	34	HEMA92-105-10	38
HC4-2	54	HEF2-165	31	HEFA4F2-125-12	39	HEFP7-10-8	34	HEMA92-105-12	11
HC4-3	54	HEF2-165	32	HEFA4F2-165-12	39	HEFP7-12	34	HEMA92-105-12	38
HC4-4	54	HEF2-165-16	32	HEFA4F2-165-16	39	HEFP43-4	34	HEMAP2-105-6	11
HC4-5	54	HEF3-4	32	HEFA7-6	37	HEFP43-6	34	HEMAP2-105-6	34
HC4-6	54	HEF3-6	32	HEFA7-8	37	HEFP43-8	34	HEMAP2-105-8	11
HC4-7	54	HEF3-6-5	32	HEFA7-10	37	HEFP43-10	34	HEMAP2-105-8	34
HC4-8	54	HEF3-8	31	HEFA7-12	37	HEFP43-12	34	HEMAP2-105-10	11
HC5-1	54	HEF3-10	31	HEFA9C7-6DS	38	HEFP47-4	34	HEMAP2-105-10	34
HC5-2	54	HEF3-12	31	HEFA9C7-8DS	38	HEFP47-6	34	HEMAP2-105-12	11
HC5-3	54	HEF7-6	31	HEFA9C7-10DS	38	HEFP47-8	34	HEMAP2-105-12	34
HC5-4	54	HEF7-6	32	HEFA9C7-12DS	38	HEFP47-10	34	HEMAP42-105-6	11
HC5-5	54	HEF7-6-4	32	HEFA9F2-45-6	39	HEFP47-12	34	HEMAP42-105-6	34
HC5-6	54	HEF7-6-5	32	HEFA9F2-55-6	39	HEFP93-4	35	HEMAP42-105-8	11
HC5-7	54	HEF7-8	31	HEFA9F2-65-6	39	HEFP93-6	35	HEMAP42-105-8	34
HC5-8	54	HEF7-10	31	HEFA9F2-85-8	39	HEFP93-8	35	HEMAP42-105-10	11
HC5-9	54	HEF7-10-8	31	HEFA9F2-115-10	39	HEFP93-10	35	HEMAP42-105-10	34
HC5-10	54	HEF7-12	31	HEFA9F2-125-12	39	HEFP93-12	35	HEMAP42-105-12	11
HC5-11	54	HEF42-65-6	32	HEFA9F2-165-12	39	HEFP97-4	35	HEMAP42-105-12	34
HC5-12	54	HEF42-85	31	HEFA9F2-165-16	39	HEFP97-6	35	HEMAP92-105-6	11
HC5-13	54	HEF42-85	32	HEFAF2-165-12	37	HEFP97-8	35	HEMAP92-105-6	34
HC5-14	54	HEF42-125	31	HEFAF2-165-16	37	HEFP97-10	35	HEMAP92-105-8	11

HEMAP92-105-8	34	HETBF2-41	45	HJ-M48	51	JT21606E	69	JT32508PD	71
HEMAP92-105-10	11	HETBF2-41-3	45	HJ-M51	51	JT21606EA	69	JT32508PE	71
HEMAP92-105-10	34	HETBF2-41-3X	45	HJ-M54	51	JT22303	70	JT32606	69
HEMAP92-105-12	11	HETBF2-41X	45	HJ-M57	51	JT22303A	70	JT32606A	69
HEMAP92-105-12	34	HETBF2-42-3	45	HJ-M60	51	JT22304	70	JT32608	69
HEMP3-6	34	HETBFA2-31	45	HJ-M63	51	JT22304A	70	JT32608A	69
HEMP3-8	34	HETBFAC2-31V	45	HJ-M65	51	JT22306	70	JT32608D	69
HEMP3-10	34	HETBFC2-31V	45	HJ-M70	51	JT22306A	70	JT32608E	69
HEMP3-12	34	HETBFC2-31X	45	HJ-M76	51	JT22306D	70	JT32804	71
HEMP6-3-4	34	HETBFC2-32	45	HM-4	51	JT22306E	70	JT32804A	71
HEMP7-4	34	HETBFC2-32X	45	HM-4-5	51	JT22403	70	JT32806	71
HEMP7-8	34	HETBFP2-31	45	HM-5	51	JT22403A	70	JT32806A	71
HET1-3	45	HETBFX1-3	45	HM-5-6	51	JT22404	70	JT51410	70
HET1-4	45	HETBFX1-4	45	HM-5-8	51	JT22404A	70	JT51410A	70
HET2-31	45	HETBFX1-31	45	HM-6	51	JT22504AP	71	JT51410D	70
HET2-32	45	HETBFX2-32	45	HM-6-8	51	JT22504APD	71	JT51410E	70
HET2-41	45	HETC1-3	45	HM-8	51	JT22504APE	71	JT51412	70
HET8-3	45	HETC2-31	45	HM-8-10	51	JT22504P	71	JT51412A	70
HETAf2-31X	43	HETF2-31	43	HM-10	51	JT22504PD	71	JT51510AP	71
HETAf2-45-4	43	HETF2-31X	43	HM-12	51	JT22504PE	71	JT51510APD	71
HETAf2-55-6	43	HETF2-35	43	HRC1	91	JT22506PD	71	JT51510APE	71
HETAf27-3	44	HETF7-3	43	HS-3-4	74	JT22506PE	71	JT51510D	70
HETAf27-4	44	HETF7-4	43	HS-4-6	74	JT22604	69	JT51510E	70
HETAf27-6	44	HETF7-4-3	43	HS-6-8	74	JT22604A	69	JT51510P	71
HETAf27-8	44	HETF42-31	44	HS-8-12	74	JT22606	69	JT51510PD	71
HETAf47-3	44	HETF47-3	44	HS-10-20	74	JT22606A	69	JT51510PE	71
HETAf87-4	44	HETF92-31	44	HSC1	76	JT22606D	69	JT51512AP	71
HETAf87-6	44	HETF97-3	44	HSC2	76	JT22606E	69	JT51512APD	71
HETAf87-8	44	HETFA7-3	43	HSC3	76	JT22802	71	JT51512APE	71
HETAf97-3	44	HETFA7-4	43	HSC4	76	JT22802A	71	JT51512P	71
HETB1-3	45	HETFA7-6	43	HSC5	76	JT22804	71	JT51512PD	71
HETB1-4	45	HETFA7-8	43	HSC6	76	JT22804A	71	JT51512PE	71
HETB2-31	45	HETFA47-4	44	HSC7	76	JT31306	70	JT51610	69
HETB2-41	45	HETFA47-6	44	HSC8	76	JT31306A	70	JT51610A	69
HETB-4-3	45	HETFA47-8	44	HSC9	76	JT31308	70	JT51610D	69
HETBAN1-3	46	HETFA57-4	44	HSC10	76	JT31308A	70	JT51610DA	69
HETBAN1-3-4	46	HETFA57-6	44	HSC11	76	JT31406	70	JT51610E	69
HETBAN1-4	46	HETFA57-8	44	HSC12	76	JT31406A	70	JT51610EA	69
HETBAN1-4-3	46	HETFA97-4	44	HSC13	76	JT31406D	70	JT51612	69
HETBAN2-3	46	HETFA97-6	44	HSC14	76	JT31406E	70	JT51612A	69
HETBAN-3	45	HETFA97-8	44	HTA1	74	JT31408	70	JT52122	11
HETBAN3-3	45	HETSf27-3	44	ILBF-M76	87	JT31408A	70	JT52122	70
HETBAN-3-4	45	HETSf27-4	44	ILF7-6-10	83	JT31408D	70	JT52122D	11
HETBAN-4	45	HETSf57-3	44	ILF7-6-100	83	JT31408E	70	JT52122D	70
HETBAN-4-3	45	HETSf87-3	44	ILF7-6-240	83	JT31506	70	JT52122E	11
HETBAN4-3	46	HETSS1-3	45	ILF7-8-10	83	JT31506A	70	JT52122E	70
HETBAN6-3	46	HETSS2-31	45	ILF7-8-100	83	JT31506AP	71	JT52308	70
HETBAN7-3	46	HETSSB1-3	45	ILF7-8-240	83	JT31506P	71	JT52308A	70
HETBAN9-3	46	HETSSB2-31	45	JP-1	84	JT31508AP	71	JT52310	70
HETBAN20-3	46	HETSSF7-3	43	JP-2	84	JT31508APD	71	JT52310A	70
HETBAN-41-3	45	HETSSF47-3	44	JP-5	84	JT31508APE	71	JT52310D	70
HETBANA2-3	46	HETSSF57-4	44	JPG-1	84	JT31508D	70	JT52310E	70
HETBANA2-3-4	46	HETSSF87-3	44	JPI-1	84	JT31508E	70	JT52312	70
HETBANA2-4	46	HETSSF87-4	44	JT21303	70	JT31508P	71	JT52312A	70
HETBANA2-4-3	46	HETSSF97-3	44	JT21303A	70	JT31508PD	71	JT52410	70
HETBANA-3	45	HETT-3	46	JT21304	70	JT31508PE	71	JT52410D	70
HETBANA3-3	45	HETX1-3	45	JT21304A	70	JT31606	69	JT52410E	70
HETBANA-3-4	45	HETX2-31	45	JT21306	70	JT31606A	69	JT52412	70
HETBANA-4	45	HF-4	53	JT21306A	70	JT31608	69	JT52508APE	71
HETBANA4-3	46	HF-6	53	JT21403	70	JT31608A	69	JT52508PE	71
HETBANA7-3	46	HF-8	53	JT21403A	70	JT31608D	69	JT52510AP	71
HETBANA9-3	46	HF-10	53	JT21404	70	JT31608DA	69	JT52510APD	71
HETBANA13-3	46	HF-12	53	JT21404A	70	JT31608E	69	JT52510APE	71
HETBANA20-3	46	HF-16	53	JT21503	70	JT31608EA	69	JT52510P	71
HETBAN-M12-4	45	HF-20	53	JT21503A	70	JT32306	70	JT52510PD	71
HETBANSS1-3	46	HF-21	53	JT21504	70	JT32306A	70	JT52510PE	71
HETBANSS2-3	46	HF-22	53	JT21504A	70	JT32308	70	JT52512AP	71
HETBANSS-3	45	HF-24	53	JT21504AP	71	JT32308A	70	JT52512APD	71
HETBANSS-3-4	45	HF-26	53	JT21504APD	71	JT32308D	70	JT52512EP	71
HETBANSS-4-3	45	HF-28	53	JT21504P	71	JT32308E	70	JT52512EPA	71
HETBANSS4-3	46	HF-30	53	JT21504PD	71	JT32406	70	JT52512P	71
HETBANSS-4-4	45	HF-32	53	JT21506	70	JT32406A	70	JT52512PD	71
HETBANSS5-3	46	HF-34	53	JT21506A	70	JT32406D	70	JT52610	69
HETBANSS6-3	46	HF-36	53	JT21506APD	71	JT32406E	70	JT52610A	69
HETBANSS7-3	46	HJ-M13	51	JT21506APE	71	JT32408	70	JT52610D	69
HETBANSS9-3	46	HJ-M16	51	JT21506D	70	JT32408D	70	JT52610E	69
HETBB1-3	45	HJ-M19	51	JT21506E	70	JT32408E	70	JT52612	69
HETBBS2-31	46	HJ-M22	51	JT21506PD	71	JT32506AP	71	JT52612A	69
HETBBSL2-31	46	HJ-M25	51	JT21506PE	71	JT32506APD	71	JT52806	71
HETBC2-31	45	HJ-M28	51	JT21604	69	JT32506APE	71	JT52806A	71
HETBF1-3	45	HJ-M32	51	JT21604A	69	JT32506P	71	JT52808	71
HETBF1-4	45	HJ-M35	51	JT21606	69	JT32506PD	71	JT52808A	71
HETBF1-4-3	45	HJ-M38	51	JT21606A	69	JT32506PE	71	JT52812	71
HETBF2-31	45	HJ-M41	51	JT21606D	69	JT32508AP	71	JT52812A	71
HETBF2-32	45	HJ-M45	51	JT21606DA	69	JT32508P	71	JTMS2000C	71

JTMS2000P	71	MFA7-8-12	60	MIK17-19	54	MMA2-3-42	58	MMFY-8	62
JTMS3000C	71	MFA7-10-8	60	MIK19-21	54	MMA2-4-31	58	MMFY-10	62
JTMS3000P	71	MFA7-10-12	60	MIK21-23	54	MMA2-4-41	58	MMFY-12	62
JTMS5000C	71	MFA7-12-10	60	MIK23-25	54	MMA2-4-42	58	MMSO-3-4	58
JTMS5000P	71	MFA7-12-16	60	MIK25-27	54	MMA2-4-55	58	MMSO-3-5	58
KP1-3	55	MFA7-16-12	60	MIK27-29	54	MMA2-4-65	58	MMSO-3-6	58
KP-4	55	MFA8-3	60	MIK29-31	54	MMA2-4-85	58	MMSO-4-4	58
LFF300	78	MFA98-3-3	61	MIK31-34	54	MMA2-4-105S	11	MMSO-4-5	58
LIK1	78	MFFA8-6-6-3	64	MIK34-37	54	MMA2-6-31	58	MMSO-4-6	58
LIK2	78	MFFA8-6-6-3	85	MIK37-40	54	MMA2-6-35	58	MMSO-4-8	58
LL-03	81	MFFA8-6-6-3BK	64	MIK40-43	54	MMA2-6-41	58	MMSO-4-10	58
LL-12	81	MFFA8-8-8-3	64	MIK43-47	54	MMA2-6-42	58	MMSO-6-4	58
LL-13	81	MFFA8-8-8-3	85	MIK47-51	54	MMA2-6-45	58	MMSO-6-5	58
LL-16	81	MFFA8-10-10-3	64	MIK51-55	54	MMA2-6-45-O	58	MMSO-6-6	58
LL-16PLUS	81	MFFA8-10-10-3	85	MIK55-59	54	MMA2-6-55	58	MMSO-6-8	58
LL-20CL	82	MFFA8-12-12-3	64	MIK59-63	54	MMA2-6-55-O	58	MMSO-6-10	58
LL-22	81	MFFS3-8-8-3	64	MIK63-68	54	MMA2-6-65	58	MMSO-6-12	58
LL-30CL	82	MFFS8-3-3-3	64	MIK63-68	54	MMA2-6-65-O	58	MMSO-8-4	58
LL-32	81	MFFS8-4-4-3	64	MIK68-73	54	MMA2-6-85	58	MMSO-8-6	58
LL-90	82	MFS0-6-4	60	MIK68-73	54	MMA2-6-85-O	58	MMSO-8-8	58
LL-91	82	MFS0-6-6	60	MIK73-79	54	MMA2-6-105S	11	MMSO-8-10	58
LOC7-6	15	MFS0-8-8	60	MIK79-85	54	MMA2-8-55	58	MMSO-8-12	58
LOC7-8	15	MFS0-10-8	60	MIK85-91	54	MMA2-8-65	58	MMSO-8-16	58
LOC7-10	15	MFS0-10-10	60	MIK91-97	54	MMA2-8-85	58	MMSO-10-6	58
LOC7-12	15	MFS3-8-3	60	MIK97-104	54	MMA2-8-105S	11	MMSO-10-8	58
LOC7-16	15	MFS3-8-6	60	MIK104-112	54	MMA2-10-65	58	MMSO-10-10	58
LOICAT1	14	MFS3-8-6S	60	MIL5547-XCOOL	93	MMA2-10-85	58	MMSO-10-12	58
LOICAT1	17	MFS3-8-8	60	MIL5792-CVL	93	MMA2-10-95	58	MMSO-12-4	58
LOILOT1S	14	MFS3-8-10	60	MIL5862-5L	92	MMA2-10-105S	11	MMSO-12-6	58
LOILOT1S	17	MFS5-4-45	60	MIL6204KB-DIESE	93	MMA2-12-65	58	MMSO-12-8	58
LOT90393482	33	MFS5-4-55	60	MIL6250KB-PETRO	93	MMA2-12-85	58	MMSO-12-10	58
LOT90393483	33	MFS5-4-85	60	MIL7627ME-DIESE	93	MMA2-12-95	58	MMSO-12-12	58
LOT90393484	33	MFS5-6-31	60	MIL7628ME-PETRO	93	MMA2-12-105	58	MMSO-12-16	58
LOT90393485	33	MFS5-6-105K	60	MIL7795ME-DPF	93	MMA2-12-105S	11	MMSO-12-20	58
LOT90393486	33	MFS5-6-115	60	MIL7877-GGB	92	MMA2-12-115	58	MMS1-3	58
LSK1	15	MFS5-8-85	60	MIL7911-GCT	92	MMA2-12-125	58	MMS1-4	58
LWC7-16	15	MFS5-8-105	60	MIL7911-JCT	92	MMA2-12-145	58	MMS1-4-4F	58
LWC7-20	15	MFS5-8-125	60	MIL7912-GCT	92	MMA2-12-165	58	MMS1-4-5	58
LWC7-24	15	MFS5-55-4	60	MIL7912-JCT	92	MMA2-16-105S	11	MMS1-6-5	58
LWC-M16	15	MFS5-85-8	60	MIL7913-GCT	92	MMA2-16-125	58	MMS1-6-7	58
LWC-M18	15	MFS6-3-3	60	MIL7913-JCT	92	MMA2-16-165	58	MMS1-8	58
LWC-M24	15	MFS6-4-4	60	MIL7914-GCT	92	MMA-3	58	MMS1-10-8	58
LWC-M28	15	MFS7-4-6	60	MIL7914-JCT	92	MMA3-3-6	59	MMS1-10-16	58
LWC-M32	15	MFS7-5-4	60	MIL7915-GCT	92	MMA-3-4	59	MMS1-12	58
LWC-M35	15	MFS7-5-5	60	MIL7917-VSPE	93	MMA3-6-8	59	MMS1-12-8	58
LWC-M38	15	MFS7-5-6	60	MIL7918MA-EPS	93	MMA3-8	59	MMS2-3-31X	58
LWC-M45	15	MFS7-6-4	60	MIL7919MA-TANK	93	MMA3-8-10	59	MMS2-4-31	58
LWP-43	14	MFS7-6-5	60	MIL7920MA-CVLE	93	MMA3-10	59	MMS2-4-41	58
LWT-43	14	MFS7-6-6	60	MIL7953-1L	92	MMA-4-3	58	MMS2-6-31	58
MAS1	73	MFS7-6-8	60	MIL7953-5L	92	MMA-4-4	58	MMS2-6-45	58
MAS2	73	MFS7-8-6	60	MIL7956-1L	92	MMA-4-6	58	MMS2-6-55	58
MAS3	73	MFS7-8-8	60	MIL7956-5L	92	MMA4-8	59	MMS2-6-65	58
MAS4	73	MFS7-10-12	60	MIL7957-1L	92	MMA4-10-J	59	MMS2-6-85	58
MAS5	73	MFS7-12	60	MIL7957-5L	92	MMA5-6-105S	11	MMS2-6-95	58
MAS6	73	MFS8-3-3	60	MIL7959-1L	92	MMA5-8-105S	11	MMS2-8-55	58
MAS7	73	MFS8-4-2	60	MIL7959-5L	92	MMA5-10-85	59	MMS2-8-65	58
MAS8	73	MFS9-3-7	23	MIL7960-1L	93	MMA5-10-105S	11	MMS2-8-85	58
MAS9	73	MFS9-3-7	60	MIL7960-5L	93	MMA5-12-105S	11	MMS2-10-65	58
MBRSS7-3	65	MFS9-6-7	60	MIL7963-1L	92	MMA-6-3	58	MMS2-10-85	58
MBTS7-3	65	MFS9-7-3	60	MIL7963-5L	92	MMA-6-4	58	MMS2-16-125	58
MBTSS7-3	65	MFS10-3-3	60	MIL7964GMS-5L	92	MMA-6-6	58	MMS2-31	58
MEF7-6	60	MFS10-6-4	60	MIL7965-1L	92	MMA-6-8	58	MMS3-3-3	59
MEF7-8	60	MFS10-8-3	60	MIL7965-5L	92	MMA-8	58	MMS3-3-4	25
MEF7-10	60	MFS10-8-4	60	MIL7966-1L	92	MMA-8-4	58	MMS3-3-4	59
MEF7-12	60	MFS10-8-6	60	MIL7967-1L	92	MMA-8-6	58	MMS3-3-6	25
MFA2-3-31	60	MFS13-3X-31	60	MIL7968-1L	92	MMA-10	58	MMS3-3-6	59
MFA2-6-45	60	MFS43-8	61	MIL7969-1L	92	MMA-10-6	58	MMS3-3-8	59
MFA2-6-45X	60	MFS43-10	61	MIL7970-1L	92	MMA-10-8	58	MMS3-4-4	59
MFA2-6-55	60	MFS93-3	61	MIL7976-300+	93	MMA-10-12	58	MMS3-4-6	59
MFA2-6-55X	60	MFS93-4	61	MIL7977-DOT5	93	MMA-12	58	MMS3-4-8	59
MFA2-12-125	60	MFS93-6	61	MIL7990-1L	92	MMA-12-8	58	MMS3-6-6	59
MFA2-12-165	60	MFS93-8	61	MLL8-3	91	MMA-12-10	58	MMS3-6-8	59
MFA2-16-165	60	MFS93-10	61	MMA1-6-4	58	MMA14-6-105S	11	MMS3-6-10	59
MFA2-105-55	11	MFS97-6	60	MMA1-10-2	58	MMA-16-10	58	MMS3-8-8	59
MFA2-105-65	11	MFS97-8	60	MMA1-10-7	58	MMA98-6	61	MMS3-8-10	59
MFA2-105-85	11	MFS97-10	60	MMA1-10-12-FS	60	MMA98-8	61	MMS3-8-12	59
MFA7-3-4	60	MFSO-12-8	60	MMA1-12-8	58	MMA98-8-4	61	MMS3-10-10	59
MFA7-3-6	60	MFSS7-3-4	60	MMA1-12-10	58	MMA98-8-6	61	MMS3-10-12	59
MFA7-4-3	60	MFSS7-3-6	60	MMA1-12-12-FS	60	MMA98-10-6	61	MMS3-12-12	59
MFA7-4-6	60	MFSS7-4-6	60	MMA1-16-12-FS	60	MMA98-10-8	61	MMS5-3-31	25
MFA7-6-4	60	MFSS7-6-4	60	MMA1-J-1	58	MMA98-10-12	61	MMS5-3-31	59
MFA7-6-8	60	MFSS7-6-8	60	MMA1-J-2X	58	MMA98-12-8	61	MMS5-3-31V	59
MFA7-6-10	60	MFSS7-8-10	60	MMA2-3-31	58	MMA98-16	61	MMS5-3-31X	59
MFA7-8-6	60	MGA1	17	MMA2-3-32	58	MMFY-6	62	MMS5-3-32	59
MFA7-8-10	60	MGA1	33	MMA2-3-41	58	MMFY-6-6-8	62	MMS5-3-32V	59

MMS5-3-32X	59	MMS9-3-6V	59	MTS14-4	50	OC5103-6	12	OCI887	17
MMS5-3-35	59	MMS9-3-7	59	MTS14-5	50	OC5103-8	12	OCI964	17
MMS5-3-41	25	MMS9-3V	59	MTS14-5-3-5	50	OC5133-6	12	OCI997	17
MMS5-3-41	59	MMS9-3X	59	MTS14-6	50	OC5133-8	12	OCI998	17
MMS5-3-41V	59	MMS9-4-3	59	MTS14-6-5-6	50	OC5133-8	12	OCI999	17
MMS5-3-42	59	MMS9-4-4	59	MTS14-8	50	OC5133-10	12	OCI1000	17
MMS5-3-45	59	MMS9-4-4X	59	MTSS-03	49	OC5161-12	12	OCI1037	17
MMS5-3-45X	25	MMS9-4-6	59	MTSS7-3	61	OC5191-12	12	OCI1179	17
MMS5-3-45X	59	MMS9-4-6FX	59	MYB14-4	50	OC13	13	OCI1201	17
MMS5-4-31	59	MMS9-6-5	59	MYB14-5	50	OC16	13	OCI1204	17
MMS5-4-35	59	MMS9-6-7	59	MYB14-6	50	OC19	13	OCI1205	17
MMS5-4-41	59	MMS9-8-7	59	MYB14-8	50	OC140	17	OCI1230	17
MMS5-4-42	59	MMS9-8-8	59	NH32NR	78	OCI41	17	OCI1251	17
MMS5-4-42V	59	MMS9-8-10	59	NH38F	78	OCI42	17	OCI1283	17
MMS5-4-45	59	MMS9-10-8	59	NH38NR	78	OCI43	17	OCI1287	17
MMS5-4-55	59	MMS9-10-10	59	NH45NR	78	OCI44	17	OCI1382	17
MMS5-4-65	59	MMS9-12-8	59	NH51	78	OCI45	17	OCI1396	17
MMS5-6-31	59	MMS9-12-10	59	NH51F	78	OCI45E	17	OCI1490	17
MMS5-6-45	59	MMS10-3-3	25	NH51NR	78	OCI45I	17	OCI1511	17
MMS5-6-55	59	MMS10-3-3	59	NH57	78	OCI/46	17	OCI1511	17
MMS5-6-65	59	MMS10-3-4	25	NH57F	78	OCI51	17	OCI1540	17
MMS5-6-85	59	MMS10-3-4	59	NH57NR	78	OCI52	17	OCI1824	17
MMS5-6-95	59	MMS10-4-3	59	NH63	78	OCI53	17	OCI1828	17
MMS5-8-65	59	MMS10-4-4	59	NH63NR	78	OCI54	17	OCI1829	17
MMS5-8-85	59	MMS10-4-6	59	NH451	78	OCI58	17	OCI1879	17
MMS5-8-95	59	MMS10-4-8	59	NH457	78	OCI60	17	OCI2391	17
MMS5-8-105	59	MMS10-6-3	59	NH938	78	OCI63	17	OCI2392	17
MMS5-8-115	59	MMS10-6-4	59	NH951	78	OCI68	17	OCI2420	17
MMS5-8-125	59	MMS10-6-6	59	NH957	78	OCI69	17	OCI2421	17
MMS5-10-85	59	MMS10-6-8	59	NHSC10-188	76	OCI71	17	OCI2422	17
MMS5-10-105	59	MMS10-8-4	59	NHSC10-250	76	OCI72	17	OCI2423	17
MMS5-10-125	59	MMS10-8-6	59	NHSC10-313	76	OCI73	17	OCI2425	17
MMS5-12-85	59	MMS10-8-8	59	NHSC10-375	76	OCI74	17	OCI2426	17
MMS5-12-95	59	MMS10-10-6	59	NHSC10-437	76	OCI75	17	OCI2427	17
MMS5-12-105	59	MMS10-10-8	59	NHSC10-500	76	OCI76	17	OCI2435	17
MMS5-12-115	59	MMS10-12-4	59	NHSC10-562	76	OCI76	17	OCI2436	17
MMS5-12-125	59	MMS10-12-6	59	NHSC10-625	76	OCI77	17	OCI2500	17
MMS6-3-3	25	MMS10-12-8	59	NHSC10-650	76	OCI78	17	OCI2501	17
MMS6-3-3	59	MMS11-3	25	NHSC10-820	76	OCI80	17	OCI2502	17
MMS6-3-4	59	MMS11-3	59	NHSC20-252	76	OCI81	17	OCI2594	17
MMS6-3-6	59	MMSB2-31-31	65	NHSC20-258	76	OCI82	17	OCI2595	17
MMS6-4-3	59	MMSB3-3	65	NHSC20-288	76	OCI83	17	OCIALF147	17
MMS6-4-4	59	MMSB3-4	65	NHSC20-323	76	OCI86	17	OCIALF156	17
MMS6-4-6	59	MMSB3-6	65	NHSC20-327	76	OCI87	17	OCITNIS1	17
MMS6-6-3	59	MMSB3-8	65	NHSC20-357	76	OCI89	17	OCIVWG40	17
MMS6-6-4	59	MMSB3-10	65	NHSC20-377	76	OCI91	17	OCV87-6	12
MMS6-6-6	59	MMSB5-3-31	65	NHSC20-432	76	OCI92	17	OCV127-6	12
MMS6-6-8	59	MMSB5-3-32	65	NHSC20-502	76	OCI93	17	OCV177-6	12
MMS6-8-4	59	MMSB7-3	65	NHSC20-522	76	OCI94	17	OCV237-6	12
MMS6-8-6	59	MMSB7-4	65	NHSC20-622	76	OCI95	17	OCV307-6	12
MMS6-8-8	59	MMSB9-3	65	NHSC20-652	76	OCI96	17	OCV87-6	12
MMS6-10-10	59	MMSB9-4	65	NHSC20-822	76	OCI97	17	OCV87-6	12
MMS6-12-8	59	MMS1-3	58	NHSC20-823	76	OCI98	17	OCV87-6	12
MMS7-3-4	57	MMS2-3-31	58	NHSC20-835	76	OCI99	17	OCV87-6	12
MMS7-4-5	57	MMS7-3	57	NHSC20-836	76	OCI104	17	OCV87-6	12
MMS7-5	57	MMS7-3-4	57	NHSC41-43751	76	OCI109	17	OCV87-6	12
MMS7-6-8	57	MMSB1-3	65	NHSC41-50051	76	OCI110	17	OCV87-6	12
MMS7-6-10	57	MMSB2-3	65	NHSC41-56251	76	OCI111	17	OCV87-6	12
MMS7-6-12	57	MMSB4-3	65	NHSC41-62551	76	OCI118	17	OCV87-6	12
MMS7-8-8	57	MMSB9-3	65	NHSC41-65051	76	OCI119	17	OCV87-6	12
MMS7-8-10	57	MON2X	77	NHSC41-82051	76	OCI122	17	OCV87-6	12
MMS7-8-12	57	MON25X	77	NHSC41-83551	76	OCI124	17	OCV87-6	12
MMS7-10-10	57	MON275	77	NIP1-1/4	51	OCI127	17	OCV87-6	12
MMS7-10-12	57	MONC2	77	NIP1-3	51	OCI128	17	OCV87-6	12
MMS7-10-16	57	MONC25	77	NIP1-3SS	51	OCI129	17	OCV87-6	12
MMS7-12-12	57	MONC275	77	NIP2-32SB	51	OCI130	17	OCV87-6	12
MMS7-12-16	57	MONCS2	78	NIP5-11	51	OCI131	17	OCV87-6	12
MMS7-16-16	57	MONS2	78	NIP5-11SS	51	OCI132	17	OCV87-6	12
MMS7-20-20	57	MTB3-3	61	NIP5-22	51	OCI133	17	OCV87-6	12
MMS8-4-4	57	MTB14-3	50	NIP5-22SS	51	OCI134	17	OCV87-6	12
MMS8-5-3	57	MTB14-4	50	NIP5-31	51	OCI135	17	OCV87-6	12
MMS8-6-3	57	MTB14-5	50	NIP5-31SS	51	OCI136	17	OCV87-6	12
MMS8-6-8	57	MTB14-6	50	NIPL1-3SS	51	OCI137	17	OCV87-6	12
MMS8-10-4	57	MTB14-8	50	NOR1R	17	OCI138	17	OCV87-6	12
MMS8-10-6	57	MTS3-3	61	NOR2R	17	OCI141	17	OCV87-6	12
MMS8-16-12	57	MTS3-4	61	OB-1.25	53	OCI142	17	OCV87-6	12
MMS9-3	59	MTS3-6	61	OB-1.75	53	OCI143	17	OCV87-6	12
MMS9-3-4	59	MTS3-8	61	OB-2.25	53	OCI144	17	OCV87-6	12
MMS9-3-4F	59	MTS3-10	61	OB-5	53	OCI146	17	OCV87-6	12
MMS9-3-4FV	59	MTS7-3	61	OB-75	53	OCI147	17	OCV87-6	12
MMS9-3-4FX	59	MTS7-4	61	OC573-8	12	OCI148	17	OCV87-6	12
MMS9-3-4V	59	MTS7-6	61	OC1162-55	12	OCI149	17	OCV87-6	12
MMS9-3-4X	59	MTS7-8	61	OC1163-10	12	OCI150	17	OCV87-6	12
MMS9-3-5V	25	MTS7-10	61	OC1193-8	12	OCI151	17	OCV87-6	12
MMS9-3-5V	59	MTS14-3	50	OC5103-6	12	OCI300	17	OCV87-6	12

OT/2H	18	RB-M39	68	RP7-12	68	SH45-M10 2	52	SH135-M60	52
OT/2J	18	RB-M41	68	RP7-16	68	SH60-M6.5	52	SH135-M63	52
OT/2K	18	RB-M43	68	RPV1	73	SH60-M8	52	SH135-M70	52
OT/2M	18	RB-M46	68	RPV2	73	SH60-M9.5	52	SH135-M76	52
OT/2SK	18	RB-M51	68	RUB1	79	SH60-M11	52	SH135-M80	52
OT/2SK92	18	RB-M60	68	RUB2	79	SH60-M13	52	SH180-M16	53
OT/4	18	RB-M74	68	RUB2V	79	SH60-M16	52	SH180-M19	53
OTG140	90	RB-M77	68	RUB3	79	SH60-M19	52	SH180-M22	53
OTGM7-8	18	RB-M80	68	RUB4	79	SH60-M22	52	SH180-M25	53
OTGM7-10	18	RB-M84	68	S34-19476-M16	15	SH60-M25	52	SH180-M28	53
OTGM7-12	18	RC3-3	68	S34-19476-M24	15	SH60-M28	52	SH180-M32	53
OTSP1	22	RC3-4	68	S100R6-4	30	SH60-M30	52	SH180-M35	53
OTSP1C	22	RC3-6	68	S100R6-5	30	SH60-M32	52	SH180-M38	53
OTSP1CHF	22	RC3-8	68	S100R6-6	30	SH60-M35	52	SH180-M41	53
OTSP1D	22	RC3-10	68	S100R6-8	30	SH60-M38	52	SH180-M45	53
OTSP1DHF	22	RC3-12	68	S100R6-10	30	SH60-M41	52	SH180-M48	53
OTSP1F	22	RC3-16	68	S100R6-12	30	SH60-M45	52	SH180-M51	53
OTSP1F-25	22	RC7-3	68	SB3LHO	80	SH60-M48	52	SH180-M54	53
OTSP1FHF	22	RC7-4	68	SB3LKA	80	SH60-M51	52	SH180-M57	53
OTSP1G	22	RC7-6	68	SB3LSU	80	SH60-M54	52	SH180-M60	53
OTSP1GHF	22	RC7-8	68	SB3LSU/03	80	SH60-M57	52	SH180-M63	53
OTSP1HF	22	RC7-10	68	SB3LTR	80	SH60-M60	52	SH180-M76	53
OTSP16	22	RC7-12	68	SB3LYA/DU	80	SH60-M63	52	SH-M6.5	51
PBT1	56	RC7-16	68	SGS3-5-BL	75	SH60-M70	52	SH-M8	51
PC1	22	RE-AG-003	81	SGS-250	75	SH60-M76	52	SH-M9.5	51
PEM7-6-5GM	68	RES1	73	SGS-375	75	SH60-M80	52	SH-M11	51
PEM7-6-6GM	68	RES2	73	SGS-500	75	SH90-M6.5	52	SH-M13	51
PEM7-6-8GM	68	RES3	73	SGS-625	75	SH90-M8	52	SH-M16	51
PEM7-8-6GM	68	RES4	73	SGS-750	75	SH90-M9.5	52	SH-M19	51
PEM7-8-8GM	68	RFH1A	23	SGS-875	75	SH90-M11	52	SH-M22	51
PHSC-M3	76	RFH1B	23	SGS-1000	75	SH90-M13	52	SH-M25	51
PHSC-M5	76	RFH1C	23	SH30-M6.5	51	SH90-M14	52	SH-M28	51
PHSC-M6	76	RFH1D	23	SH30-M8	51	SH90-M16	52	SH-M32	51
PHSC-M8	76	RFH1E	23	SH30-M9.5	51	SH90-M18	52	SH-M35	51
PHSC-M10	76	RFH1F	23	SH30-M11	51	SH90-M19	52	SH-M38	51
PHSC-M13	76	RFH1G	23	SH30-M13	51	SH90-M20	52	SH-M41	51
PHSC-M16	76	RFH1H	23	SH30-M16	51	SH90-M22	52	SH-M45	51
PHSC-M19	76	RFH2E	23	SH30-M19	51	SH90-M25	52	SH-M48	51
PHSC-M25	76	RFH2EB	23	SH30-M22	51	SH90-M28	52	SH-M51	51
PHSC-M27	76	RFH2G	23	SH30-M25	51	SH90-M30	52	SH-M54	51
PHSC-M32	76	RFH2GB	23	SH30-M28	51	SH90-M32	52	SH-M57	51
PHSC-M37	76	RFH2GB-M22	23	SH30-M30	51	SH90-M35	52	SH-M60	51
PRO50	83	RFH2GB-M22BK	23	SH30-M32	51	SH90-M38	52	SH-M63	51
PRO804	83	RFH3A	23	SH30-M35	51	SH90-M41	52	SH-M70	51
PRO805	83	RFH3AB	23	SH30-M38	51	SH90-M45	52	SH-M76	51
PRO806	83	RFH3B	23	SH30-M41	51	SH90-M48	52	SH-M80	51
PWO5927	12	RFH3BB	23	SH30-M45	51	SH90-M51	52	SH-M83	51
PWO5929	12	RFH4	23	SH30-M48	51	SH90-M54	52	SH-M89	51
PWO5931	12	RFH5	23	SH30-M51	51	SH90-M57	52	SH-M102	51
PWO5933	12	RFH6	23	SH30-M54	51	SH90-M60	52	SHR-M19-M16	53
QF250	81	RFH6B	23	SH30-M57	51	SH90-M63	52	SHR-M22-M16	53
QF250CF	81	RFH7	23	SH30-M60	51	SH90-M65	52	SHR-M25-M19	53
QF250TNA	81	RFK1	23	SH30-M63	51	SH90-M70	52	SHR-M32-M25	53
QFB1	81	RFK2	23	SH30-M70	51	SH90-M76	52	SHR-M38-M32	53
QFBC1	81	RFK3	23	SH30-M76	51	SH90-M80	52	SHR-M45-M38	53
QFF250C	81	RFK4	23	SH30-M80	51	SH90-M83	52	SHR-M54-M51	53
QFK1	13	RFK5	23	SH30-M83	51	SH90-M89	52	SHR-M57-M51	53
QFM250TF	81	RIN1	79	SH30-M89	51	SH90-M102	52	SHR-M70-M50	53
QFMAN	81	RIN2	79	SH30-M102	51	SH90R-M16-M13	53	SHR-M76-M51	53
QFMAN45	81	RIN3	79	SH45-M6.5	52	SH90R-M25-M19	53	SHR-M102-M76	53
QFMAN80	81	RIN4	79	SH45-M8	52	SH90R-M35-M32	53	SLA1	73
QFR252	81	RIN6	80	SH45-M9.5	52	SH90R-M38-M32	53	SLF7-4	83
QFSYS1	81	RIN7	79	SH45-M11	52	SH90R-M38-M35	53	SLF7-6	83
QFSYS2	81	RN1	79	SH45-M13	52	SH90R-M45-M25	53	SLF7-8	83
QFT251	81	RN2	79	SH45-M16	52	SH90R-M57-M51	53	SLF14-5	83
QFT252	81	RN3	79	SH45-M19	52	SH90R-M60-M51	53	SLF14-6	83
QM251	81	ROV2-6-65	80	SH45-M22	52	SH135-M6.5	52	SLM141-6	11
QMH252	81	ROV2-65	80	SH45-M25	52	SH135-M8	52	SLM141-10	11
QMV252	81	ROV2-65+	80	SH45-M28	52	SH135-M9.5	52	SLM141-14	11
QR-03	91	ROV7-6	80	SH45-M32	52	SH135-M11	52	SLM250-6	11
QR-03-22P	91	ROV7-6+	80	SH45-M35	52	SH135-M13	52	SLM250-10	11
R9-M4.8	30	ROV7-8	80	SH45-M38	52	SH135-M16	52	SLM250-14	11
R9-M5.6	30	ROV7-10	80	SH45-M41	52	SH135-M19	52	SLM420-6	11
R9-M6.3	30	ROV7-12	80	SH45-M45	52	SH135-M22	52	SLM420-10	11
R9-M7.3	30	RP3-3	68	SH45-M48	52	SH135-M25	52	SLM420-14	11
R9-M7.9	30	RP3-4	68	SH45-M51	52	SH135-M28	52	SLM420-14-M18	11
R9-M9.5	30	RP3-6	68	SH45-M54	52	SH135-M32	52	SLM592-6	11
R9-M12.7	30	RP3-8	68	SH45-M57	52	SH135-M35	52	SLM592-10	11
R9-M15.6	30	RP3-10	68	SH45-M60	52	SH135-M38	52	SLM592-14	11
RB-M8	68	RP3-12	68	SH45-M63	52	SH135-M41	52	SP1	22
RB-M10	68	RP7-3	68	SH45-M70	52	SH135-M45	52	SP1A	22
RB-M15	68	RP7-4	68	SH45-M76	52	SH135-M48	52	SP1B	22
RB-M18	68	RP7-6	68	SH45-M80	52	SH135-M51	52	SP1C	22
RB-M27	68	RP7-8	68	SH45-M83	52	SH135-M54	52	SP1D	22
RB-M31	68	RP7-10	68	SH45-M89	52	SH135-M57	52	SP1E	22

SP1F	22	TEMB47-6	55	THV45	80	VRJ6-6	80	WOS7-8	67
SP1F-25	22	TEMB92-55	55	TN1-3	55	VRJ6-8PP	80	WOS7-10	67
SP1G	22	TEMB97-6	55	TN1-4	55	VRM16-6	80	WOS7-12	67
SP3	22	TET	55	TN1-31	55	W991-08DE	55	WOS7-16	67
SP4	22	TETF7-6	55	TN1S-4	55	W991-10DE	55	WSP-3/8	65
SP5	22	TFE2	43	TN2-3	55	W991-12DE	55	WSP-5/8	65
SP6	22	TFE3	43	TN2-4	55	W991-16DE	55	WSP-M10	65
SP7	22	TFE3B	43	TN2-31	55	W991-20DE	55	WTG110	90
SP9	22	TFE3O	43	TN4-4	55	W991-24DE	55	XR1	79
SP10	22	TFE3PINK	43	TOP1	22	W991-28DE	55	XR1H	79
SP11	22	TFE3R	43	TOP1A	22	W991-32DE	55	XR1L	79
SP12	22	TFE3Y	43	TOP1B	22	W991-40DE	55	XR1S	79
SP13	22	TFE4	43	TOP1C	22	W991-48DE	55	XR2	79
SP14	22	TFE4C	43	TOP1D	22	W991-64DE	55	XR2H	79
SP15	22	TFE6	43	TOP1F	22	W994-16D	55	XR2L	79
SP16	22	TFE6C	43	TOP1G	22	WC-1/4	73	XR2S	79
SP16N	22	TFE8	43	TOP1O	22	WC3/4	73	XR3	79
SP24	22	TFE8C	43	TOP2N	22	WC-3/8	64	XR3H	79
SP31	22	TFECAR3	43	TOP3	22	WC-3/8	73	XR3S	79
SP100	22	TFEPVC3	43	TOP7	22	WC3/8	73		
SP100F	22	TFEPVC3BLU	43	TOP8	22	WC5/8	73		
SP100G	22	TFEPVC3G	43	TOP9	22	WC7/16	64		
SPH1-4	50	TFEPVC3TBLUE	43	TOP16A	22	WC9/16	73		
SPH1-5	50	TFEPVC3TRED	43	TOP16E	22	WC-M10	64		
SPH1-6	50	TFEPVC4	43	TOP17	22	WC-M10	73		
SPH2-4	50	TGA2-85	22	TOP19	22	WC-M12	64		
SPH2-5	50	TGA2A	22	TOP20	22	WC-M12	73		
SPH2-6	50	TGA2B	22	TOP21	22	WCM18	73		
SPH3-4	50	TGA2C	22	TOP24	22	WCP1	84		
SPH3-5	50	TGA2D	22	TOP24T	22	WCP1B	84		
SPH3-6	50	TGA2E	22	TOP25	22	WCP1C	84		
SPH8-4	50	TGA2F	22	TOP26	22	WCS3/8	73		
SPH8-5	50	TGA2G	22	TOP27	22	WCS7/16	73		
SPH8-6	50	TGA2H	22	TOP29	22	WCS-M10	73		
SPV1	90	TGA2I	22	TOPO1	22	WEB1	39		
SPV1A	90	TGA2J	22	TOPO1C	22	WEB1BK	39		
SPV1B	90	TGA2K	22	TOPO1D	22	WEB2	39		
SPV1C	90	TGA2L	22	TOPO1F	22	WEB2BK	39		
SPV1D	90	TGA2M	22	TOPO6	22	WEB3	39		
SPV1E	90	TGA2N	22	TP1	25	WEB3BK	39		
SPV1F	90	TGA2O	22	TP2	25	WFP1	82		
SPV1G	90	TGA3-65	22	TP3	25	WFP2	82		
SR9-M4.8	30	TGA3A	22	TP4	25	WFP3	82		
SR9-M5.6	30	TGA3B	22	TP5	25	WFR2	82		
SR9-M6.3	30	TGA3C	22	TP6	25	WFR3	82		
SR9-M7.3	30	TGA3D	22	TP7	25	WIB1	68		
SR9-M7.9	30	TGA3E	22	TP8	25	WLP1	84		
SR9-M9.5	30	TGA3F	22	TP9	25	WO2-M14	68		
SR9-M12.7	30	TGA3G	22	TP12	25	WO2-M16	68		
SR9-M15.6	30	TGA3H	22	TPVW	25	WO2-M18	68		
ST1	74	TGA3I	22	TRL6	80	WO2-M22	68		
ST1RED	74	TGA3J	22	TRL7	80	WO2-M26	68		
STA1	81	TGA3K	22	TRL8	80	WO2-M30	68		
TAP3-4	73	TGA3M	22	TRL68	80	WO3-3	67		
TAP3-4-4	73	TGA3N	22	TRV45	80	WO3-4	67		
TAP3-6	73	TGA3O	22	TRV67	80	WO3-6	67		
TAP3-6-5	73	TGA4-105	22	TRV86	80	WO3-8	67		
TAP3-6-6	73	TGA4A	22	TS1	26	WO3-10	67		
TAP3-8	73	TGA4B	22	TS2	26	WO3-12	67		
TAP7-6	73	TGA4C	22	TS3	26	WO3-16	67		
TAP7-8	73	TGA4D	22	TS-M10	74	WO7-3	67		
TAP7-10	73	TGA4E	22	TS-M14	74	WO7-4	67		
TAP7-12	73	TGA4F	22	TS-M20	74	WO7-6	67		
TAT-3-4	56	TGA4G	22	TS-M30	74	WO7-8	67		
TBG2	90	TGA4H	22	TS-M35	74	WO7-10	67		
TBG30	90	TGA4I	22	TTEC11001	74	WO7-12	67		
TBV45	80	TGA4J	22	TTEC11002	74	WO7-16	67		
TCP1	84	TGA4K	22	TTEC11031	74	WO8-8	68		
TCP3	84	TGA4M	22	TTEC11032	74	WO14-8	67		
TCP240VOLTS	84	TGA4N	22	TTEC13575	74	WO15-6	67		
TDP1	85	TGA4O	22	TTEC14002	74	WO15-12	67		
TDP2	85	TGA5	22	VFS-4	55	WOF2-21	68		
TEB	55	TGA5	87	VFS-5	55	WOF2-31	68		
TEB45	55	TGA21	22	VFS-6	55	WOF2-M12	68		
TEB90	55	TGA31	22	VFS-8	55	WOF2-M14	68		
TEBAND-M12	55	TGA41	22	VFS-10	55	WOF2-M16	68		
TEBAN-M12	55	TGASP	22	VFS-12	55	WOF2-M18	68		
TEF2-55	55	TGASP1	22	VH-3	50	WOF2-M22	68		
TEF7-6	55	TGASP1/8NPTF	22	VH-6	50	WOF7-6	67		
TEF92-55	55	TGASP200	25	VH-M3	50	WOF8-3	68		
TEF97-6	55	TGASP200D	25	VH-M4	50	WOF2-85	68		
TEM2-55	55	TGASP200F	25	VH-M5	50	WOFSS2-85	68		
TEM3-4	55	TGASPM14	22	VH-M6	50	WOS7-3	67		
TEM7-6	55	TGASPM16	22	VH-M8	50	WOS7-4	67		
TEMB7-6	55	TGASPM18	22	VH-M10	50	WOS7-6	67		

## Useful Charts

### Celcius to fahrenheit

$$T(^{\circ}\text{F}) = T(^{\circ}\text{C}) \times 1.8 + 32$$

$$T(^{\circ}\text{C}) = (T(^{\circ}\text{F}) - 32) / 1.8$$

°C	°F
-273.15 °C	-459.67 °F
-50 °C	-58.0 °F
-40 °C	-40.0 °F
-30 °C	-22.0 °F
-20 °C	-4.0 °F
-10 °C	14.0 °F
-9 °C	15.8 °F
-8 °C	17.6 °F
-7 °C	19.4 °F
-6 °C	21.2 °F
-5 °C	23.0 °F
-4 °C	24.8 °F
-3 °C	26.6 °F
-2 °C	28.4 °F
-1 °C	30.2 °F
0 °C	32.0 °F
1 °C	33.8 °F
2 °C	35.6 °F
3 °C	37.4 °F
4 °C	39.2 °F
5 °C	41.0 °F
6 °C	42.8 °F
7 °C	44.6 °F
8 °C	46.4 °F
9 °C	48.2 °F
10 °C	50.0 °F
20 °C	68.0 °F
30 °C	86.0 °F
40 °C	104.0 °F
50 °C	122.0 °F
60 °C	140.0 °F
70 °C	158.0 °F
80 °C	176.0 °F
90 °C	194.0 °F
100 °C	212.0 °F
200 °C	392.0 °F
300 °C	572.0 °F
400 °C	752.0 °F
500 °C	932.0 °F
600 °C	1112.0 °F
700 °C	1292.0 °F
800 °C	1472.0 °F
900 °C	1652.0 °F
1000 °C	1832.0 °F

### Inches to millimetres

$$d(\text{mm}) = d(\text{"}) \times 25.4$$

$$d(\text{"}) = d(\text{mm}) / 25.4$$

Inches (in)	Millimetres (mm)
1/64 "	0.396875 mm
1/32 "	0.793750 mm
1/16 "	1.587500 mm
0.1 "	2.540000 mm
1/8 "	3.175 mm
1/4 "	6.35 mm
1/2 "	12.7 mm
1 "	25.4 mm
2 "	50.8 mm
3 "	76.2 mm
4 "	101.6 mm
5 "	127.0 mm
6 "	152.4 mm
7 "	177.8 mm
8 "	203.2 mm
9 "	228.6 mm
10 "	254.0 mm
20 "	508.0 mm
30 "	762.0 mm
40 "	1016.0 mm
50 "	1270.0 mm
60 "	1524.0 mm
70 "	1778.0 mm
80 "	2032.0 mm
90 "	2286.0 mm
100 "	2540.0 mm

### Metres to feet

$$d(\text{ft}) = d(\text{m}) / 0.3048$$

$$d(\text{m}) = d(\text{ft}) \times 0.3048$$

Meters (m)	Feet (ft)
0.1 m	0.3281 ft
1 m	3.2808 ft
2 m	6.5617 ft
3 m	9.8425 ft
4 m	13.1234 ft
5 m	16.4042 ft
6 m	19.6850 ft
7 m	22.9659 ft
8 m	26.2467 ft
9 m	29.5276 ft
10 m	32.8084 ft
20 m	65.6168 ft
30 m	98.4252 ft
40 m	131.2336 ft
50 m	164.0420 ft
60 m	196.8504 ft
70 m	229.6588 ft
80 m	262.4672 ft
90 m	295.2756 ft
100 m	328.0840 ft

### Litres to gallons (imperial/US)

$$L = \text{ImpG} / 0.21997 = \text{USG} / 0.26417$$

$$\text{ImpG} = \text{USG} \times 0.83267$$

Liters	Imp. Gallons (UK)	US Gallons
1	0.21997	0.26417
2	0.43993	0.52834
3	0.65991	0.79252
4	0.87988	1.05669
5	1.09985	1.32086
6	1.31981	1.58503
7	1.53978	1.84920
8	1.75975	2.11338
9	1.97972	2.37755
10	2.19969	2.64172
11	2.41966	2.90589
12	2.63963	3.17006
13	2.85960	3.43424
14	3.07957	3.69841
15	3.29954	3.96258
16	3.51951	4.22675
17	3.73948	4.49092
18	3.95944	4.75510
19	4.17941	5.01927
20	4.39938	5.28344
25	5.49923	6.60430
50	10.99846	13.20860
100	21.99692	26.41720

Think Automotive was founded in 1967 to produce oil cooler installations and has continued to expand into many aspects of high performance automobile plumbing. We are now the world's biggest supplier of oil coolers and components.

Think Automotive are manufacturer and distributor of **MOCAL** and laminova products.

Think Automotive also manufacture bespoke items. Please talk to a member of staff to discuss your requirements.

Manufacturing of special items, warehousing and sales takes place at our premises in Ashford, Middx, conveniently placed for access from London, the airports and the motorway. We are happy to send products to anywhere in the world.

